

# ASSEMBLY INSTRUCTIONS

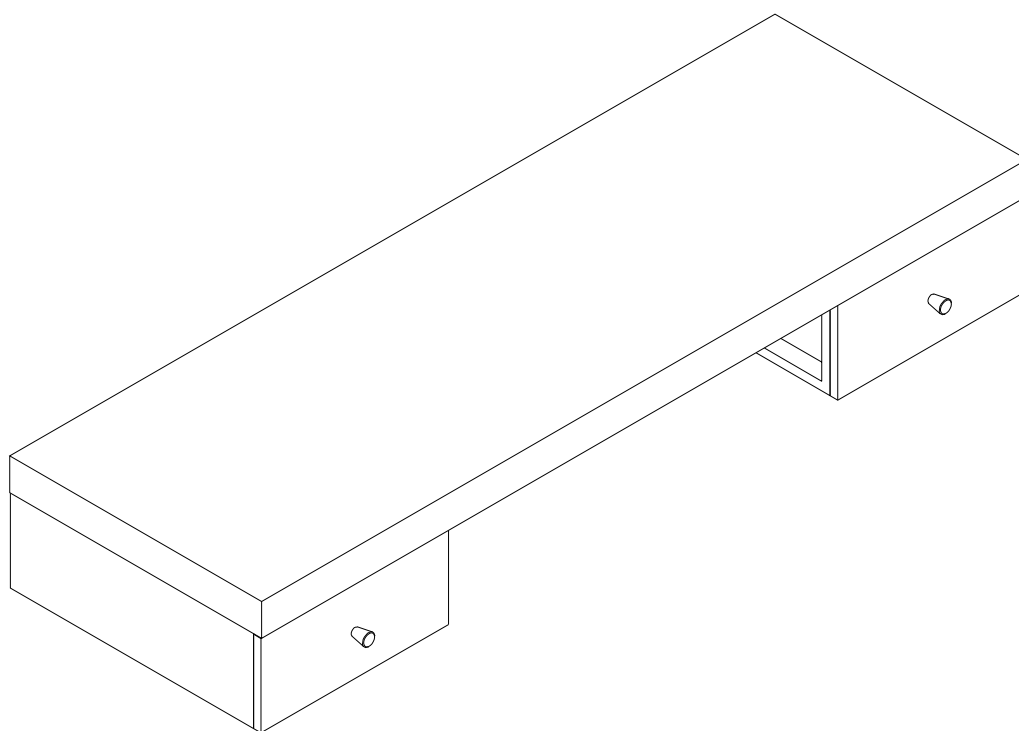

**NOTE: 50% TIGHTEN BEFORE FIXING ALL BOLTS**

**WF317213AAE/WF317213AAL**

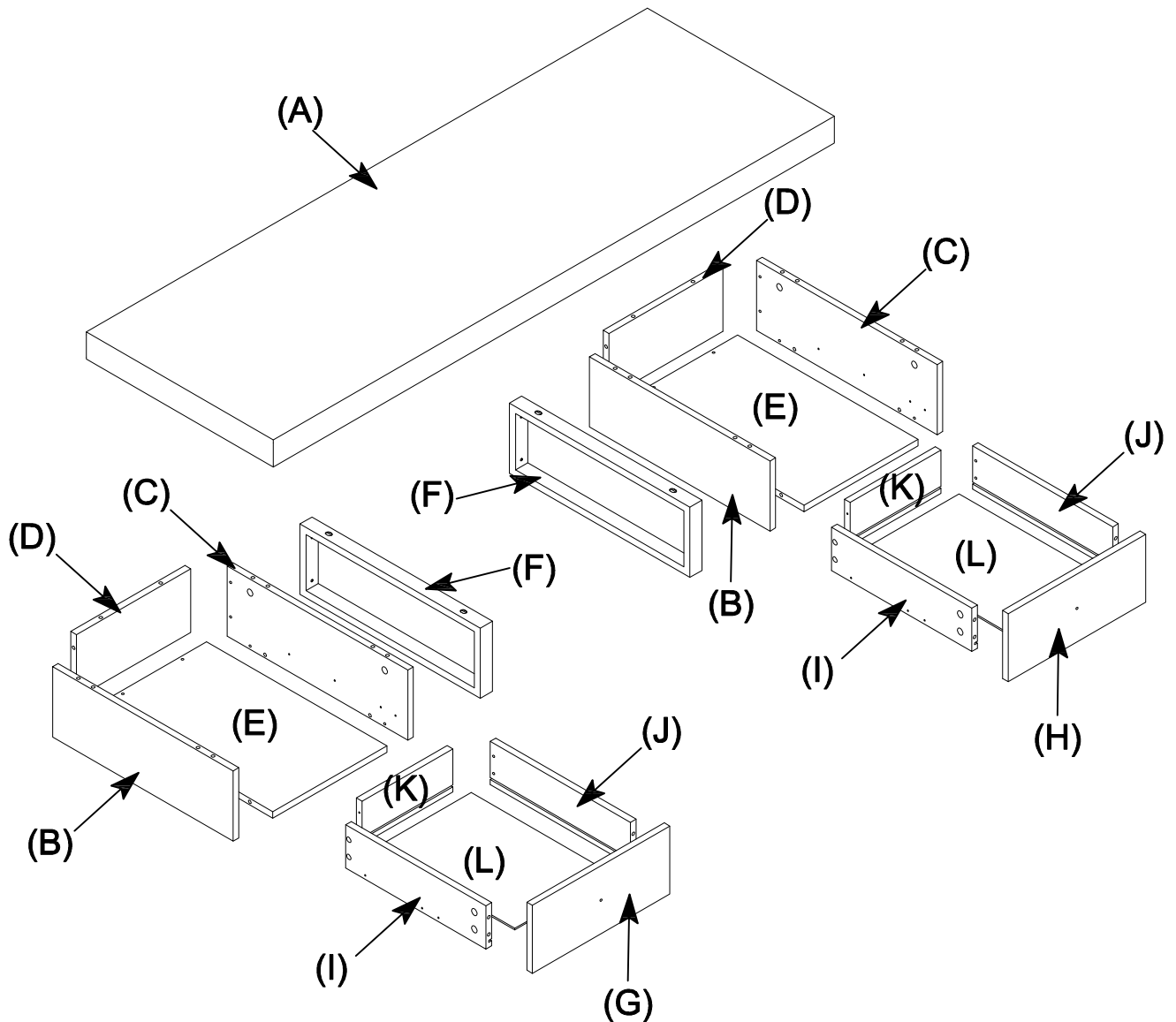

**Notice:**

1. 50% Tighten before fixing all screws, Allen wrench is recommended instead of an electric drill.
2. Place the item on a flat ground to adjust and make sure it remains stable.
3. Tighten up all screws with tools gradually.
4. If the screws are not aligned with holes during assembly, please loosen all the other screws to 50% and continue the assembly process.
5. If the item is not stable, please loosen all the screws, adjust it on a flat ground and tighten up all screws again.
6. Note : If one or some screws are fully tightened during assembly, chances are the others will not be aligned with holes. In addition, all the holes are designed to be relatively larger to provide more space for the adjustment of the screws.

# PARTS LIST

**A**

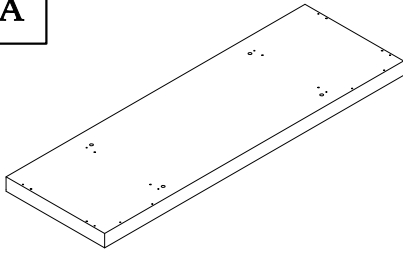

**Table Top (1PC)**

**B**

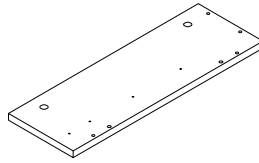

**Left Panel (2PCS)**

**C**

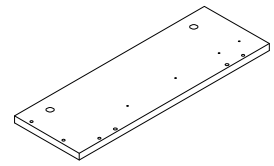

**Right Panel (2PCS)**

**D**

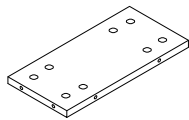

**Back Panel (2PCS)**

**E**

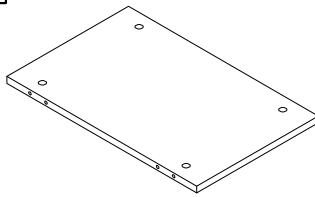

**Bottom Panel (2PCS)**

**F**

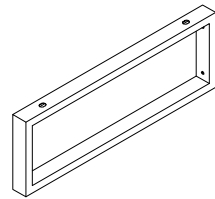

**Support Frame (2PCS)**

**G**

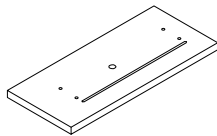

**Left Front Drawer Panel (1PC)**

**H**

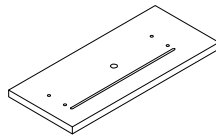

**Right Front Drawer Panel (1PC)**

**I**

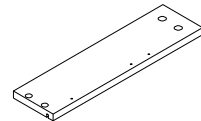

**Left Side Drawer Panel (2PCS)**

**J**

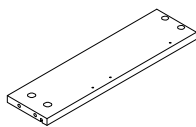

**Right Side Drawer Panel (2PCS)**

**K**

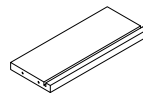





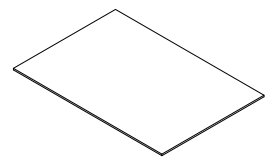

**Back Drawer Panel (2PCS)**

**L**

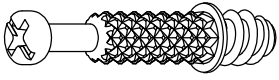
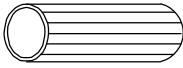
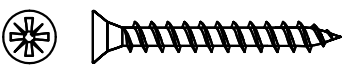
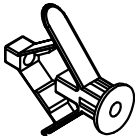
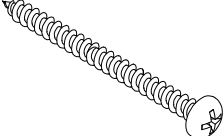
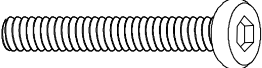

**Bottom Drawer Panel (2PCS)**

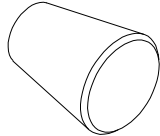
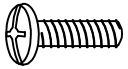
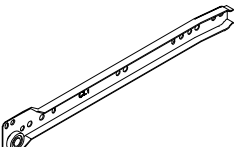
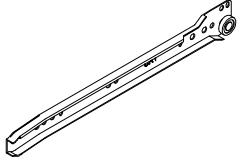
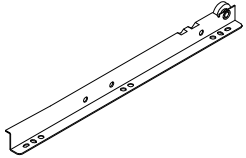
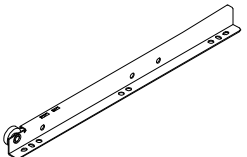
# HARDWARE LIST

<p>1</p>  <p><b>Big Cam Lock (32PCS)</b></p>	<p>2</p>  <p><b>Small Cam Lock (8PCS)</b></p>	<p>3</p>  <p><b>Cam Bolt (40PCS)</b></p>
<p>4</p>  <p><b>Ø8x30mm Wood Dowel (16PCS)</b></p>	<p>5</p>  <p><b>M4x35mm Flat Head Screw (8PCS)</b></p>	<p>6</p>  <p><b>Drywall Anchor (6PCS)</b></p>
<p>7</p>  <p><b>M4x55mm Screw (6PCS)</b></p>	<p>8</p>  <p><b>Bolt 1/4" x 25mm (4PCS)</b></p>	<p>9</p>  <p><b>Allen Key 4mm (1PC)</b></p>
<p>10</p>  <p><b>Handle (2PCS)</b></p>	<p>11</p>  <p><b>Ø5/32"x20mm Bolt with Screw Head (2PCS)</b></p>	<p>12</p>  <p><b>CL - Left Slide Track (2PCS)</b></p>
<p>13</p>  <p><b>CR - Right Slide Track (2PCS)</b></p>	<p>14</p>  <p><b>DL - Left Slide Runner (2PCS)</b></p>	<p>15</p>  <p><b>DR - Right Slide Runner (2PCS)</b></p>
<p>16</p>  <p><b>M3.5x9mm Flat Head Screw (28PCS)</b></p>		

CARTON CONTENT:

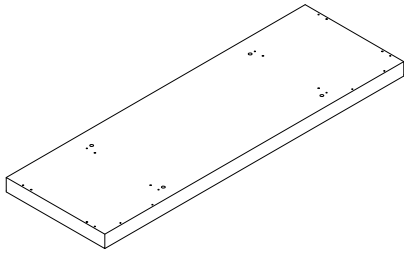

**A** x 1

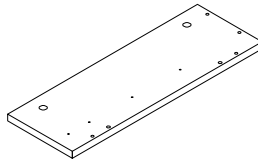

**B** x 2

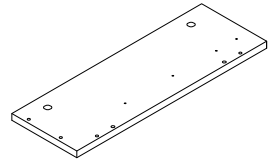

**C** x 2

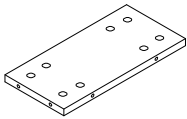

**D** x 2

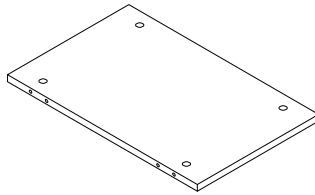

**E** x 2

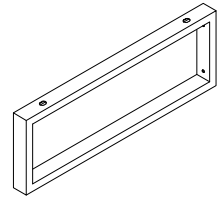

**F** x 2

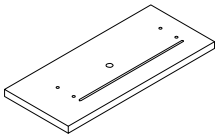

**G** x 1

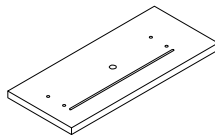

**H** x 1

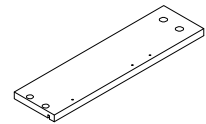

**I** x 2

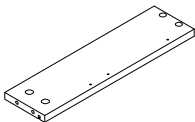

**J** x 2

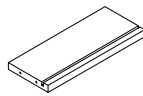

**K** x 2

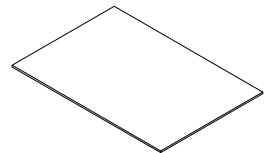

**L** x 2

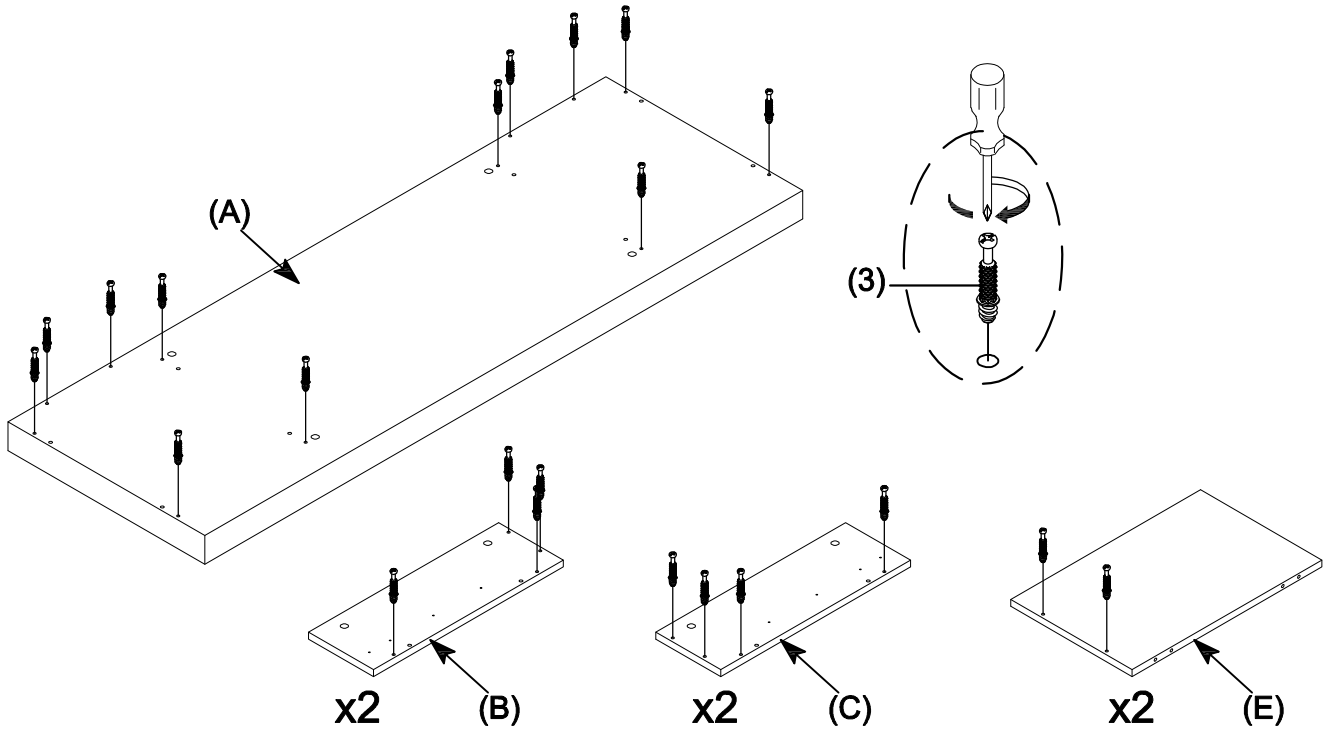

## STEP 1



3		Cam Bolt	32 pcs
---	---	----------	--------

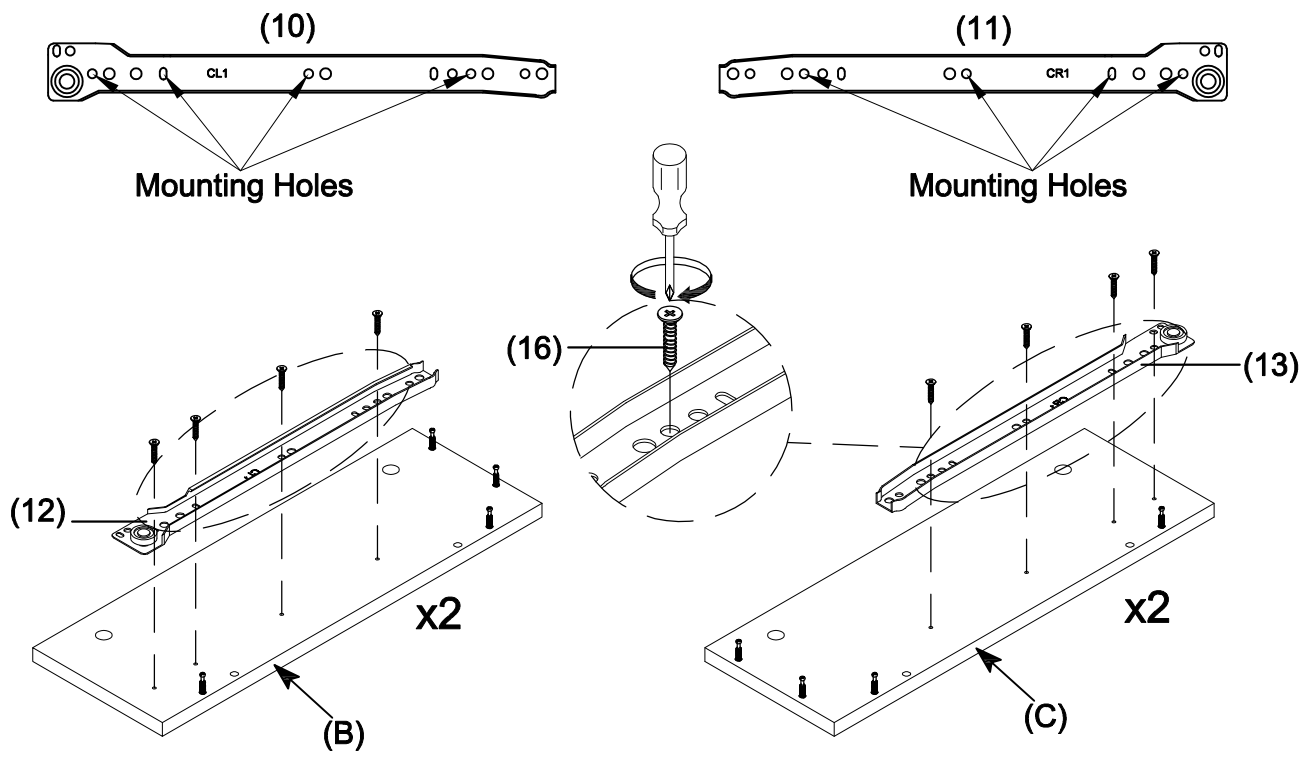

## STEP 2



12		CL - Left Slide Track	2 pcs
13		CR - Right Slide Track	2 pcs
16		M3.5x10mm Flat Head Screw	16 pcs

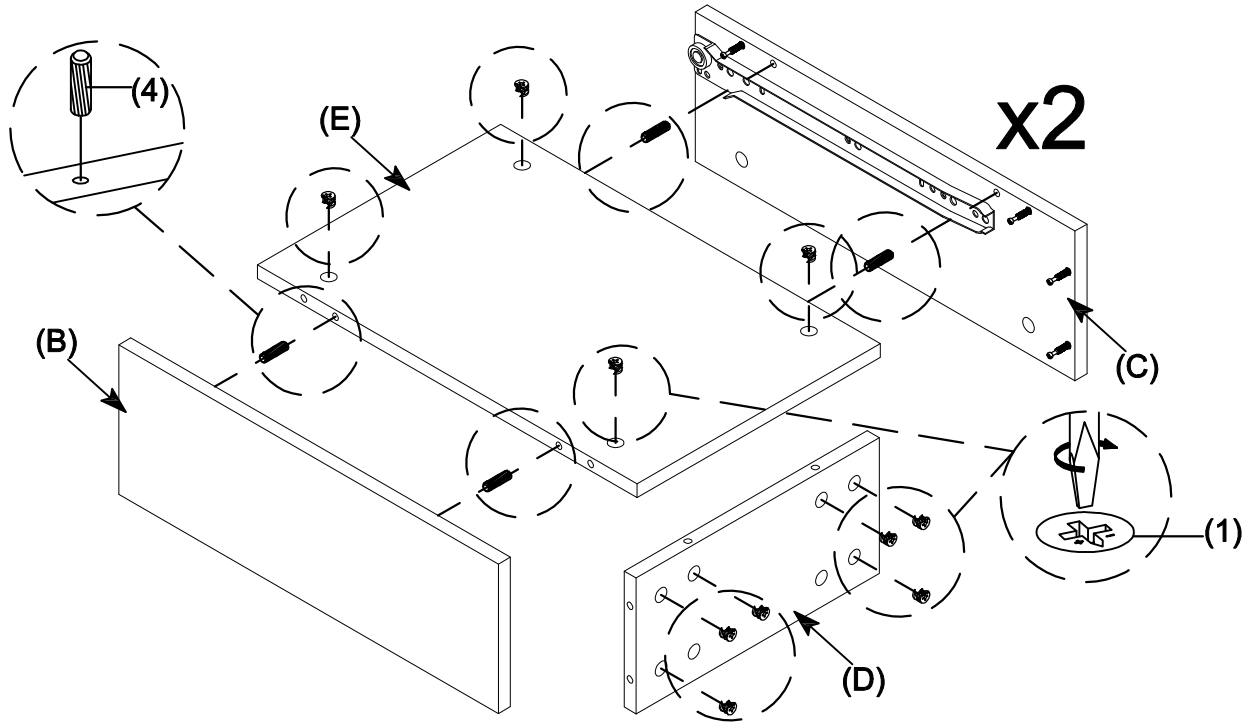

### STEP 3

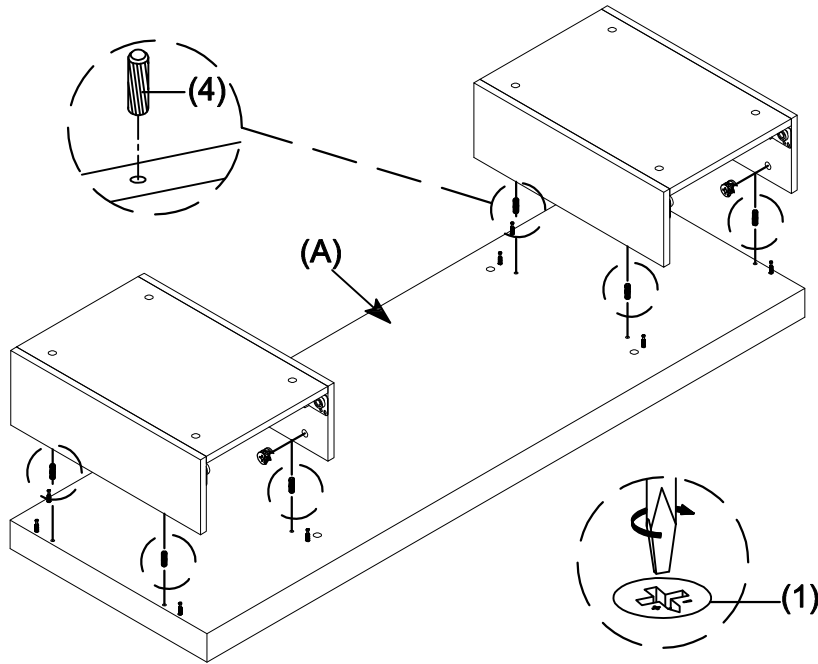

1		Big Cam Lock	20 pcs
4		Ø8x30mm Wood Dowel	8 pcs

### STEP 4



1		Big Cam Lock	8 pcs
4		Ø8x30mm Wood Dowel	8 pcs

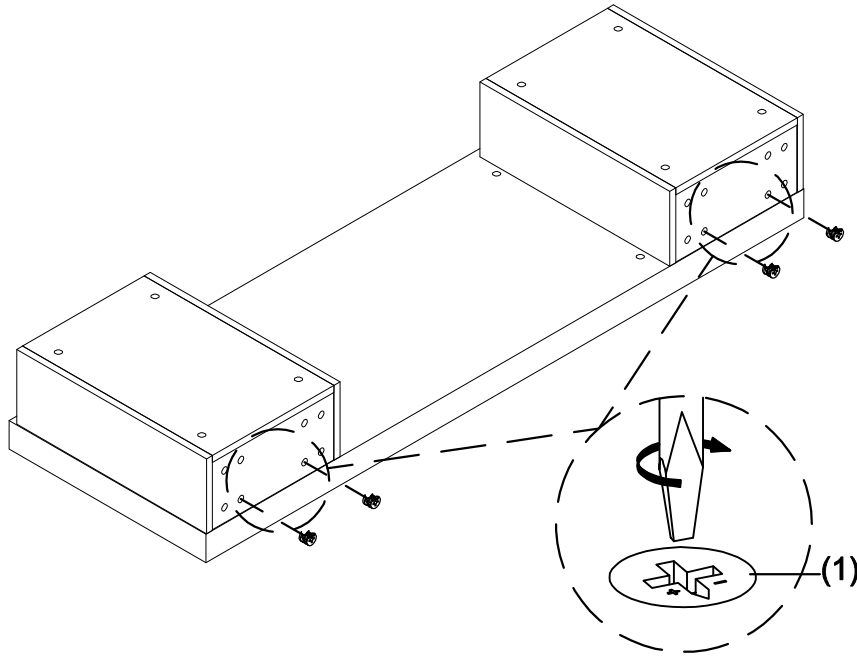

## STEP 5

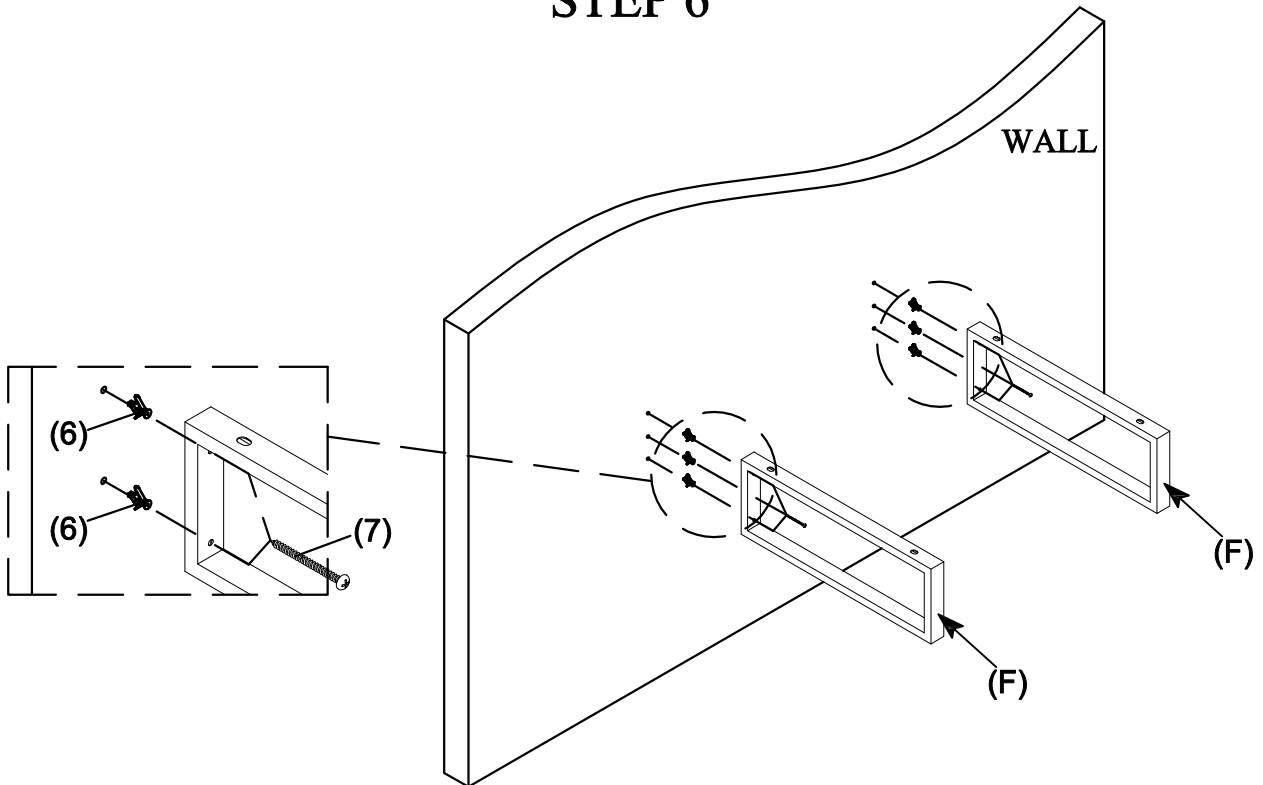

1		Big Cam Lock	4 pcs
---	---	--------------	-------

## STEP 6



6		Drywall Anchor	6 pcs
7		M4x55mm Screw	6 pcs



## STEP 7

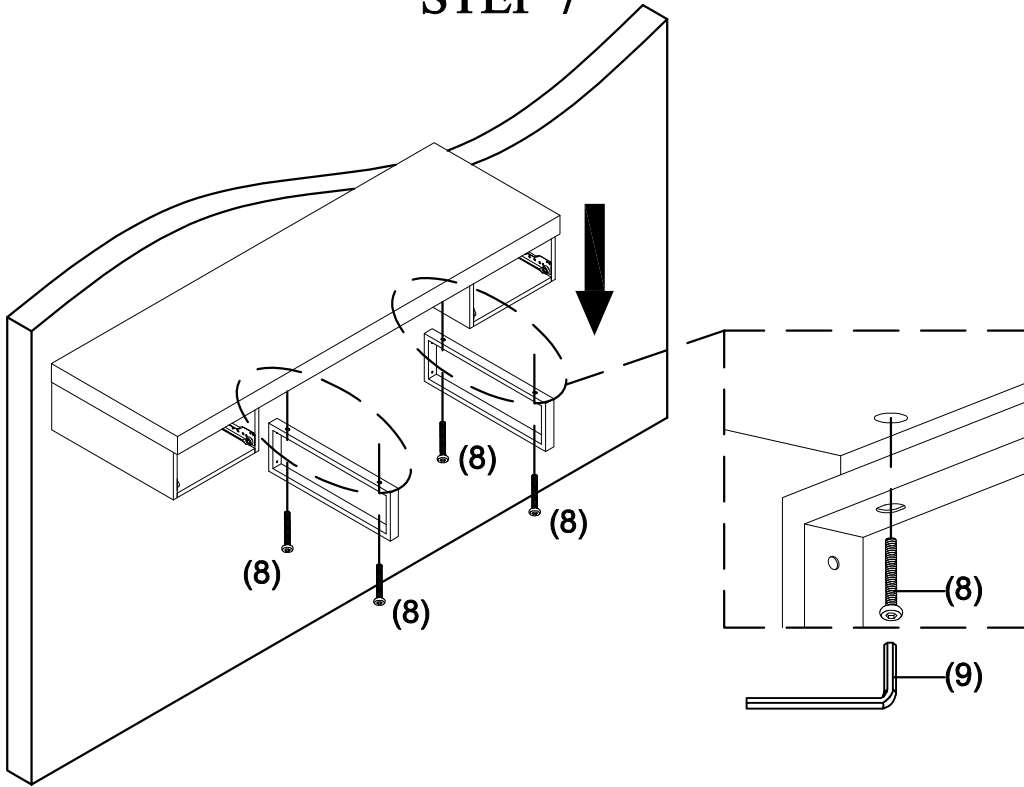

8		Bolt 1/4" x 25mm	4 pcs
9		Allen Key 4mm	1 pc

## STEP 8

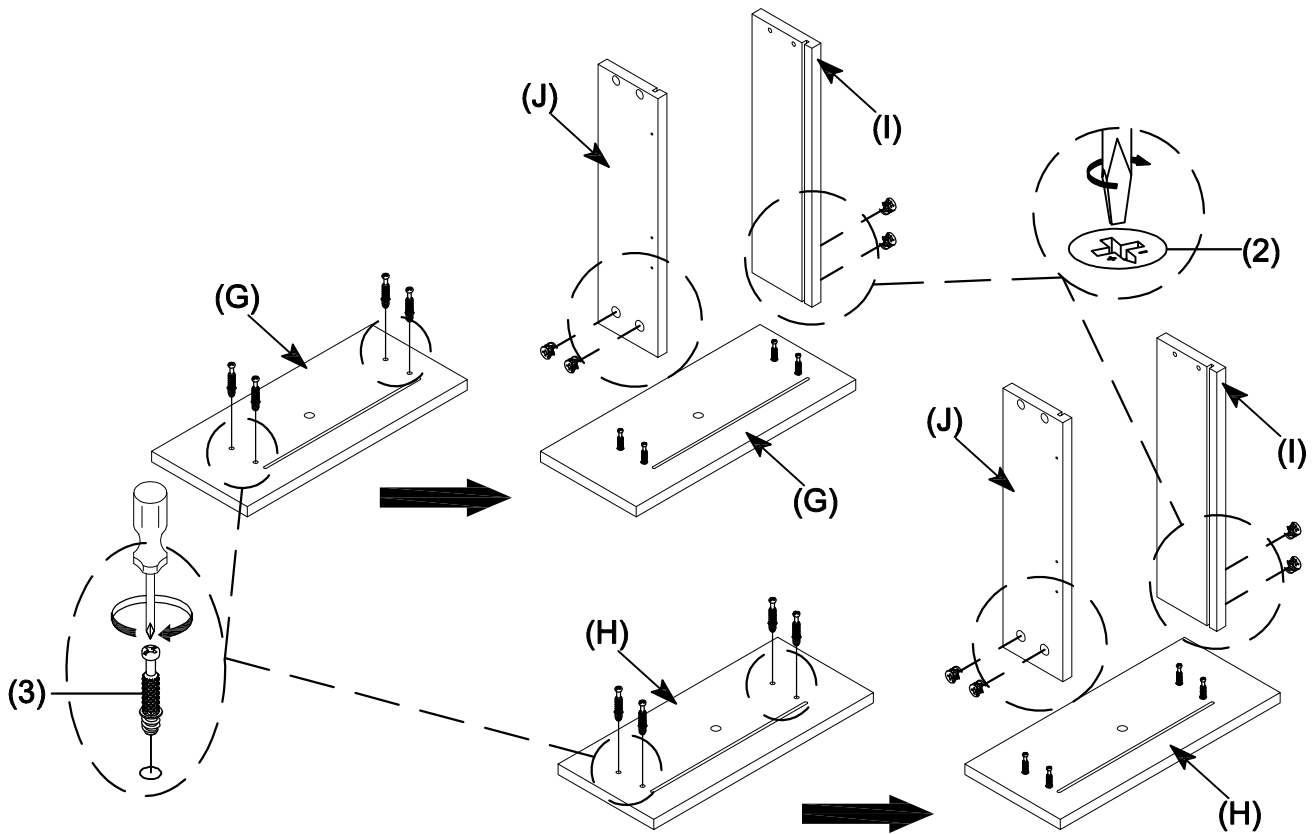

2		Small Cam Lock	8 pcs	3		Cam Bolt	8 pcs
---	--	----------------	-------	---	--	----------	-------

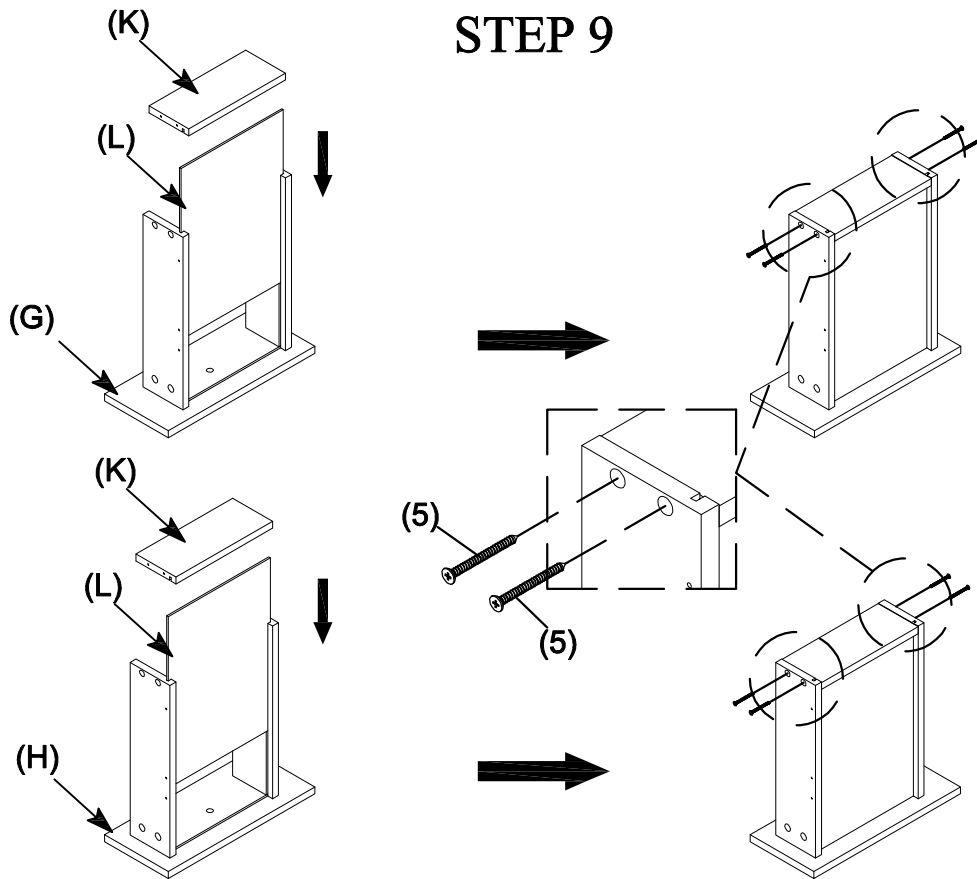

## STEP 9

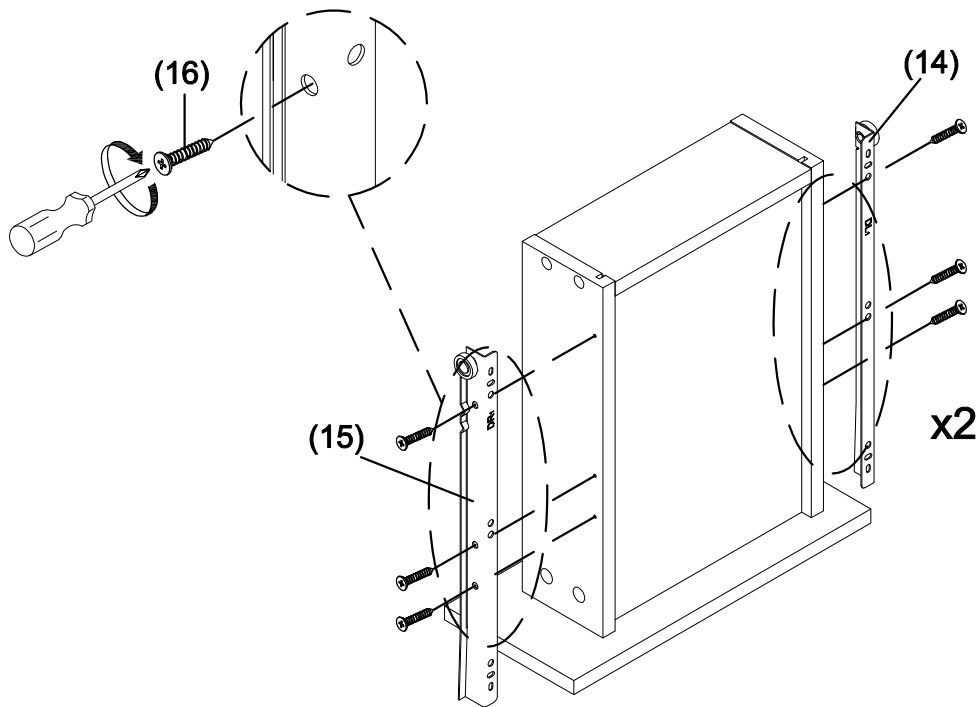

5		M4x35mm Flat Head Screw	8 pcs
---	---	-------------------------	-------

## STEP 10





14		DL - Left Slide Runner	2 pcs
15		DR - Right Slide Runner	2 pcs

16		M3.5x9mm Flat Head Screw	12 pcs
----	---	--------------------------	--------

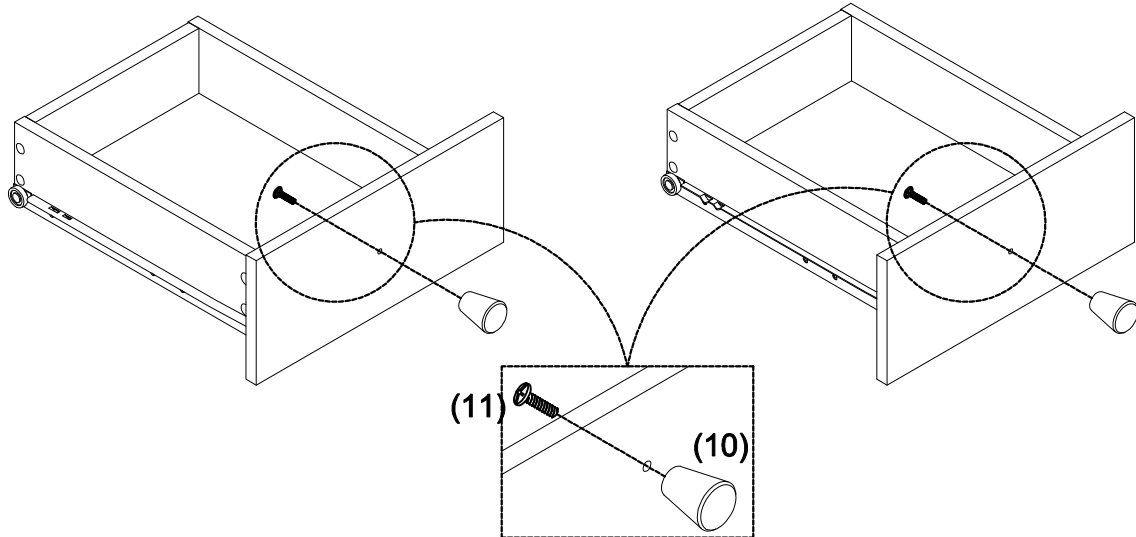
## STEP 11



10		Handle	2 pcs
11		Ø5/32"x20mm Bolt with Screw Head	2 pcs

## FINISH

