

1

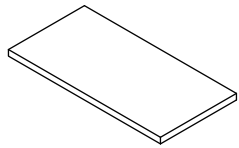

x1

2

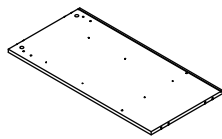

x1

3

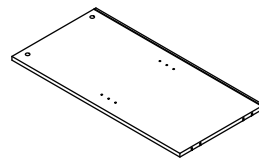

x1

4

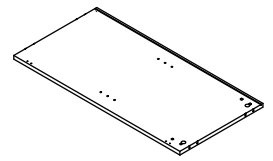

x1

5

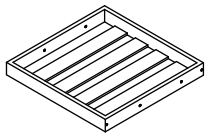

x1

6

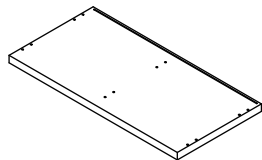

x1

7

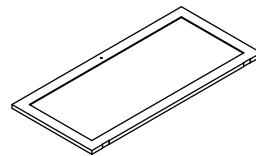

x1

8

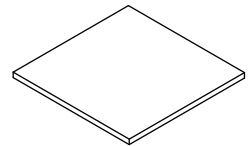

x1

9

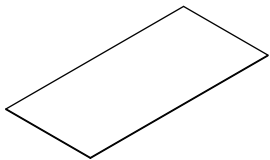

x2

10

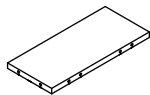

x1

11



x1

12



x1

13

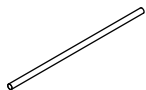

x1

14

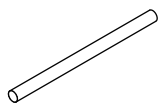

x1

15



x1

16



x1

17

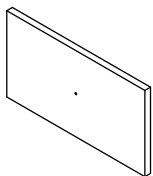

x2

18

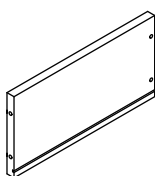

x2

19

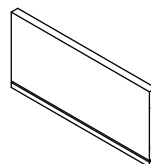

x2

20

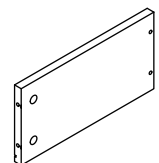

x2

21

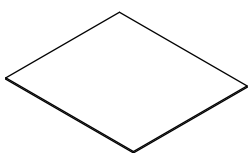

x2

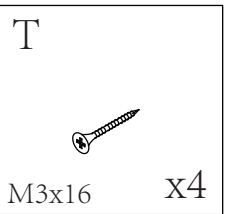
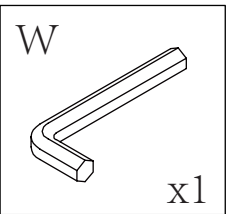
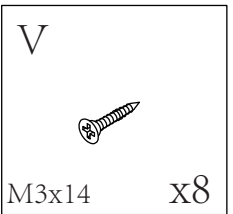
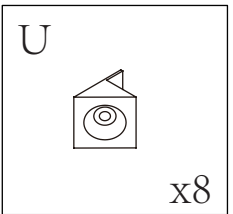
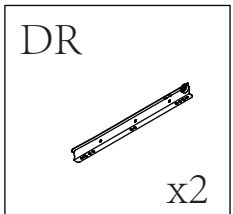
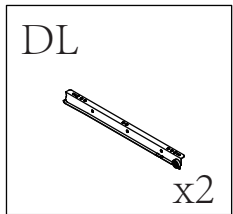
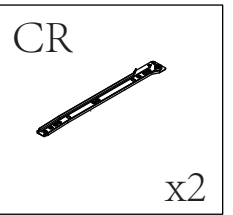
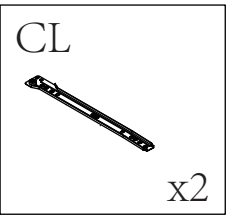
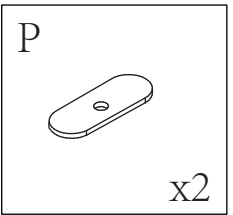
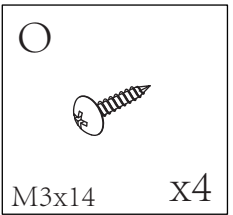
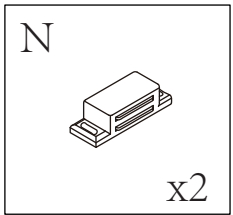
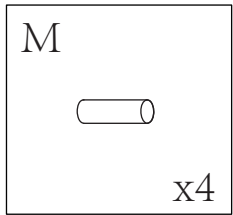
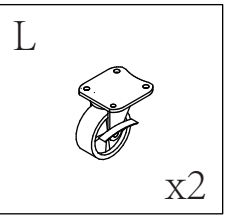
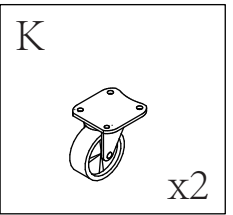
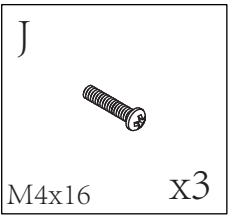
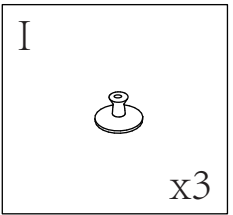
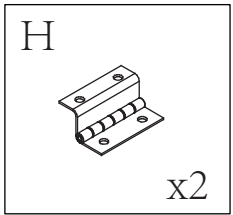
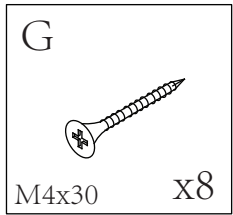
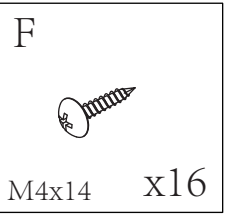
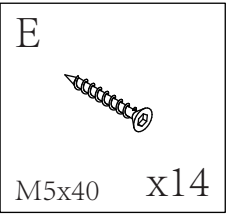
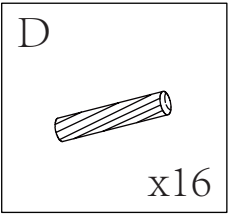
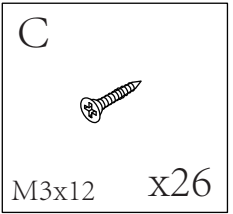
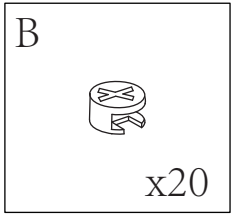
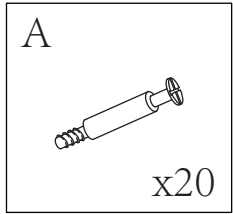

1

x2

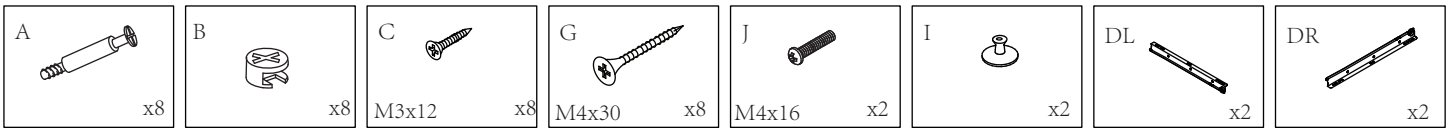
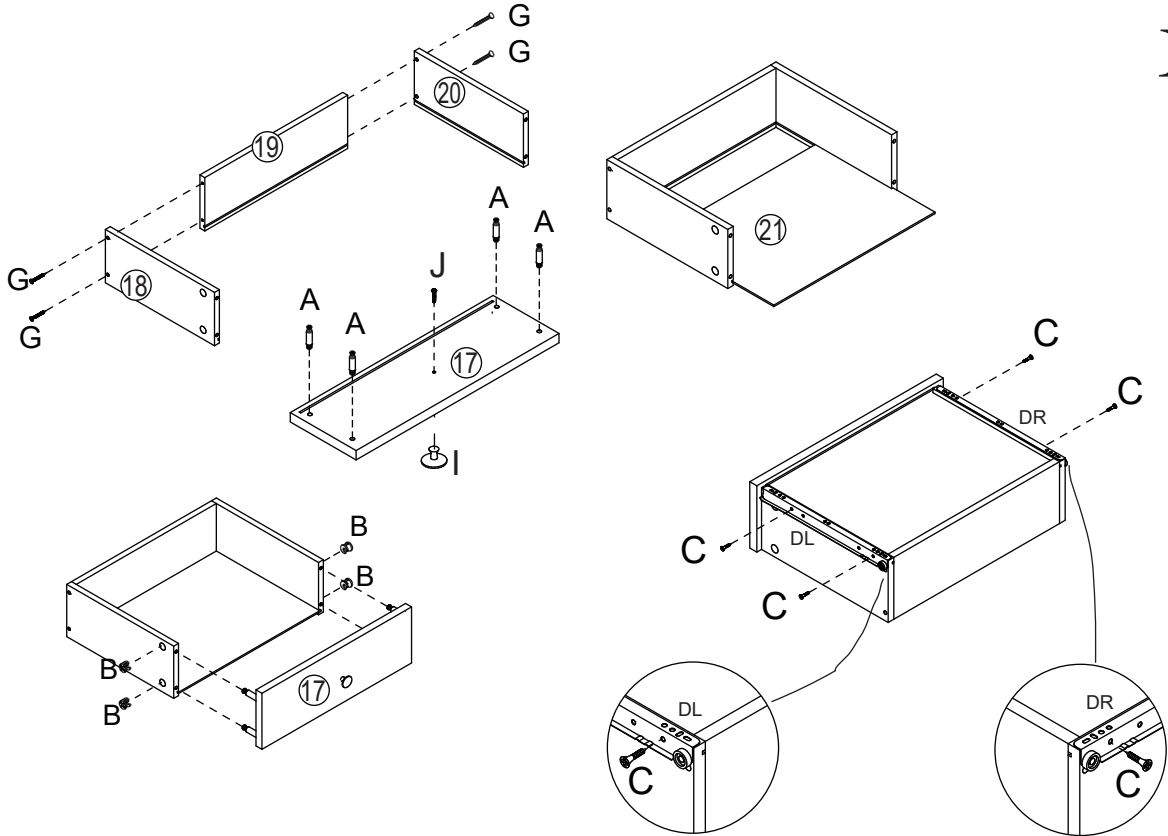

2

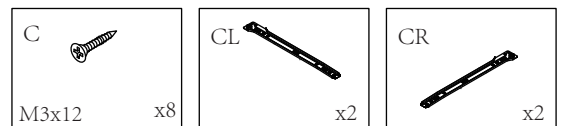
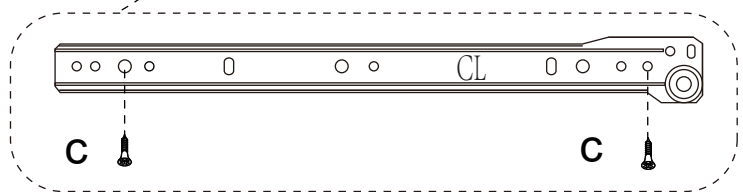
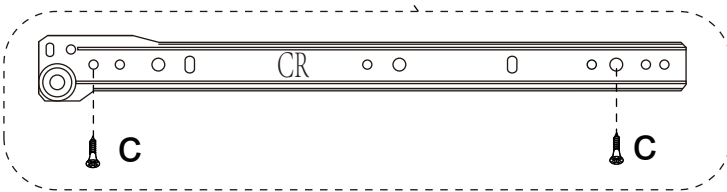
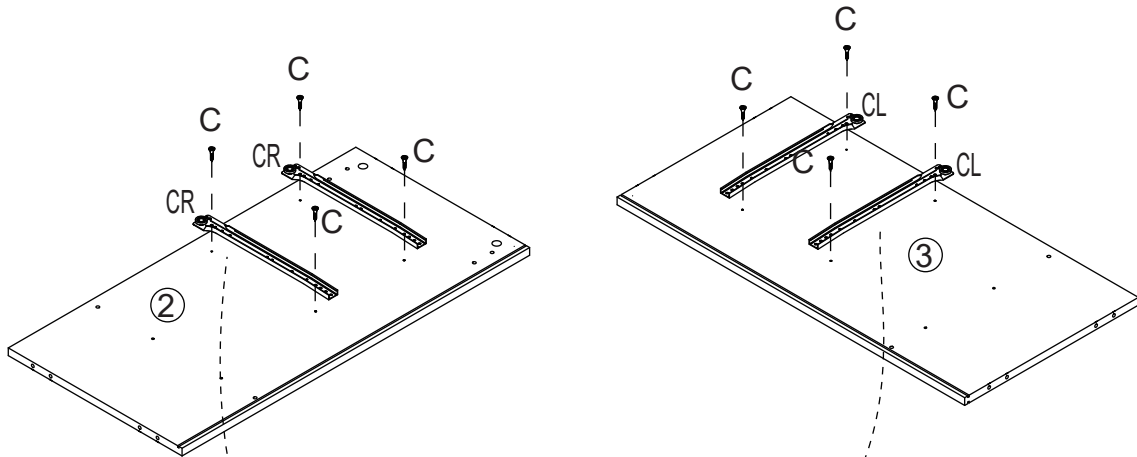

3

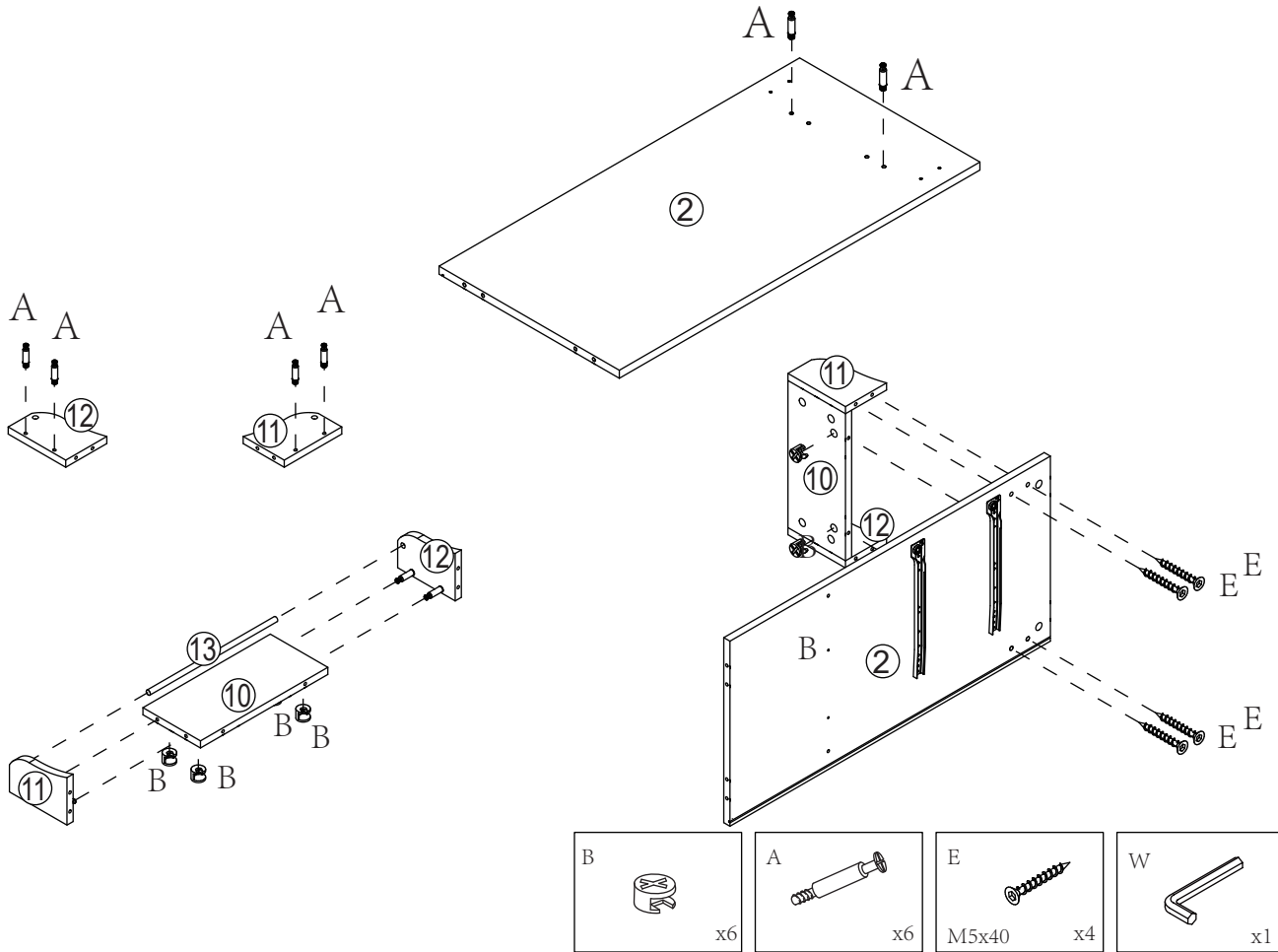

4

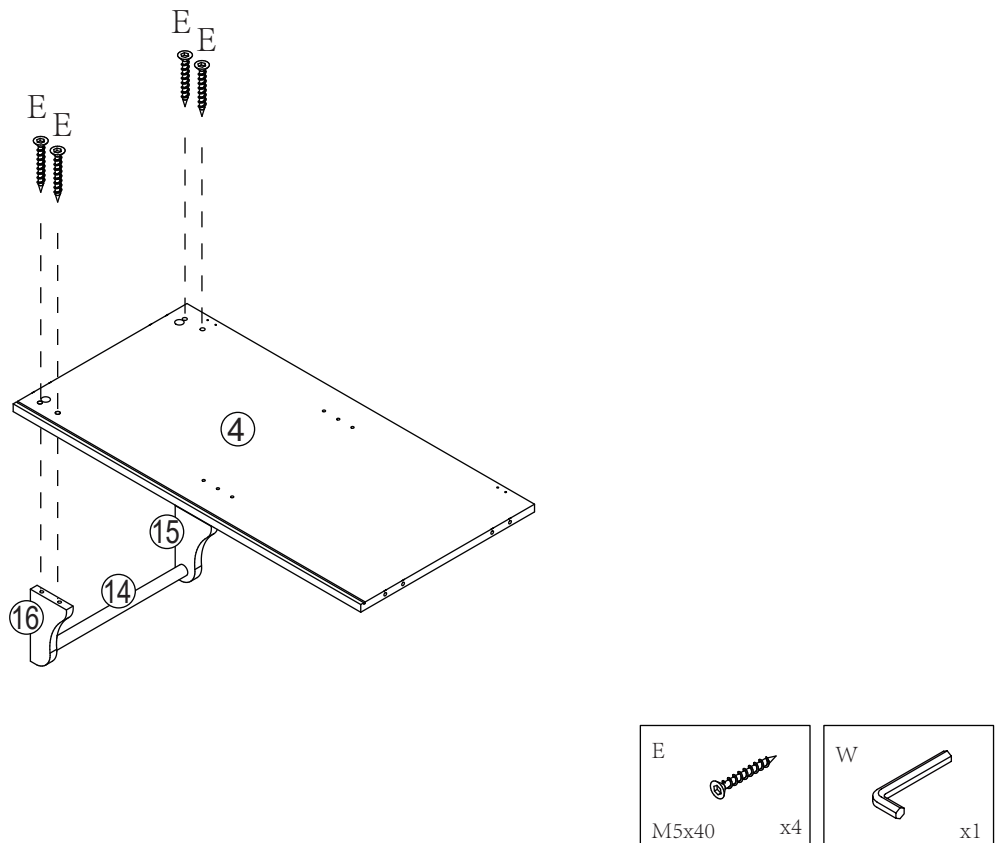

5

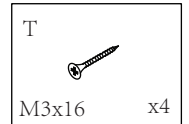
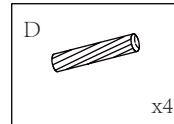
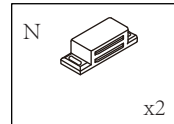
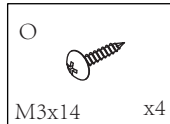
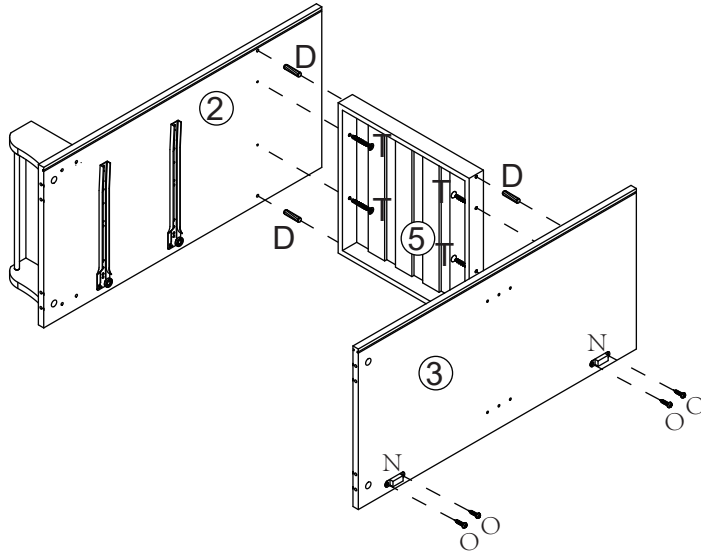

6

F x 16
L x 2
K x 2

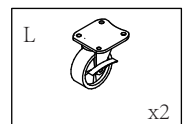
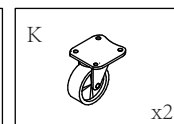
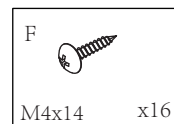
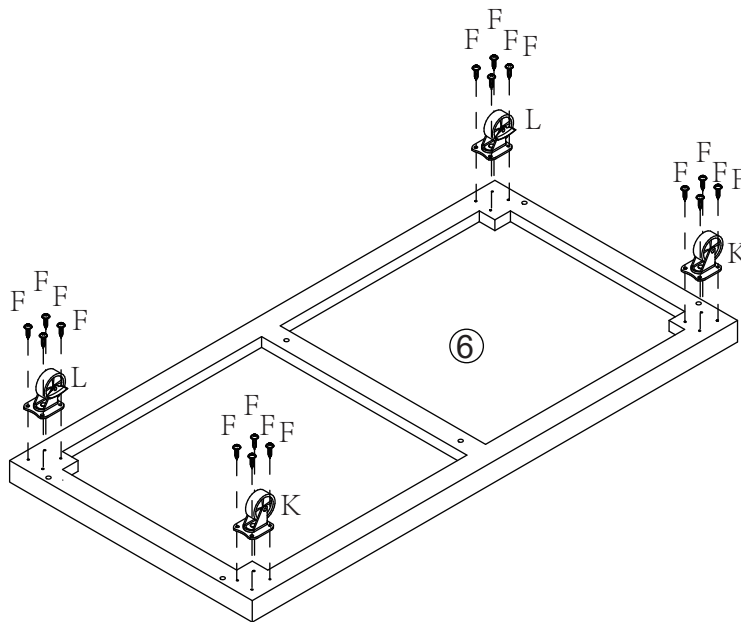

7

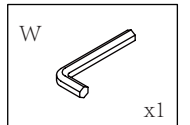
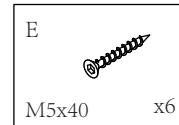
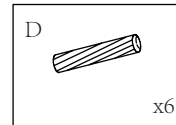
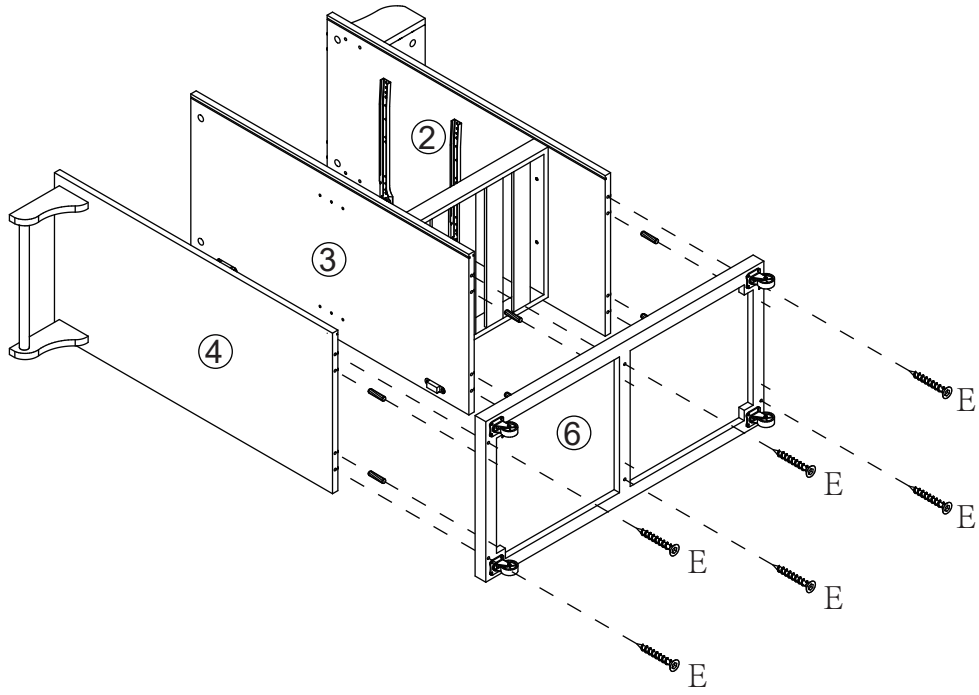

8

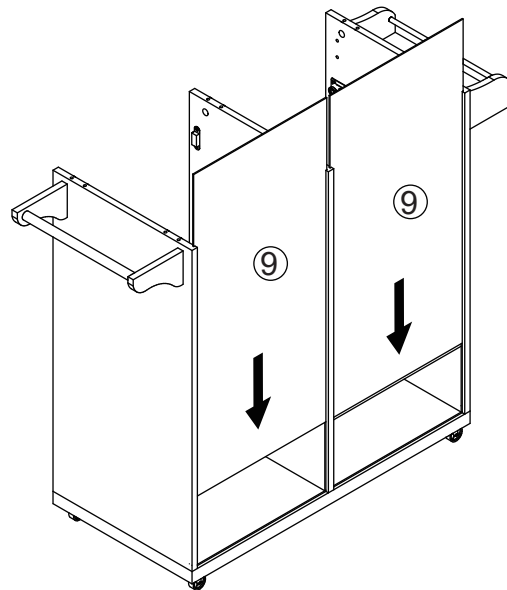

9

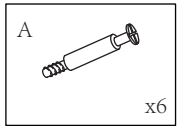
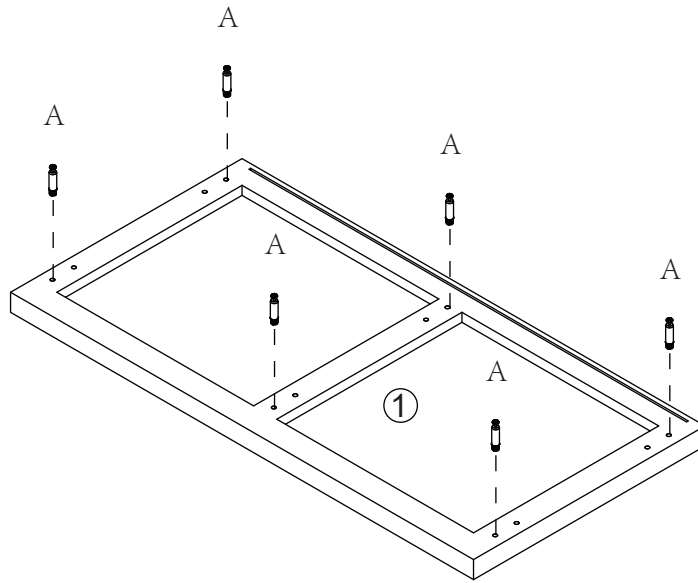

10

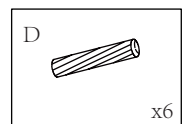
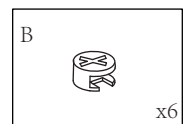
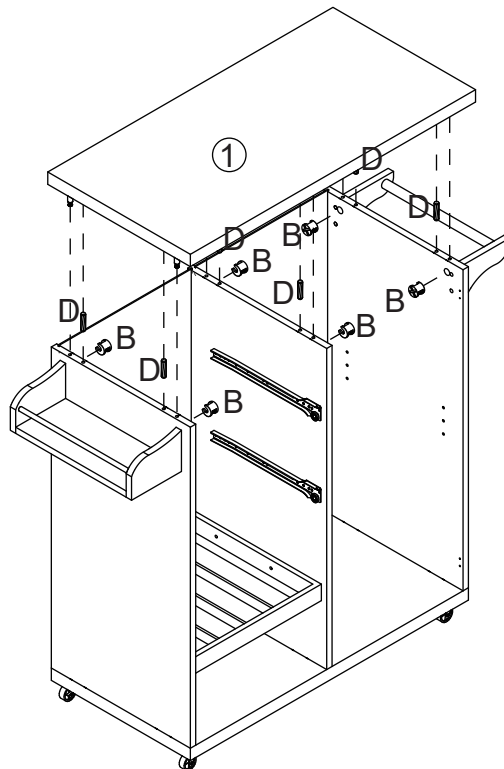

11

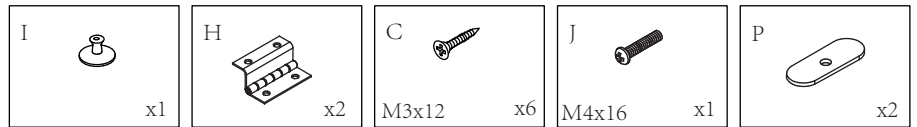
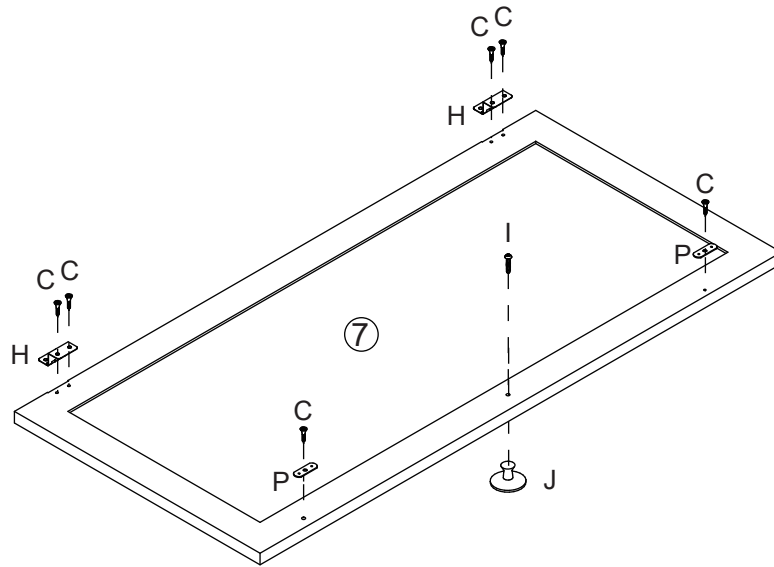

12

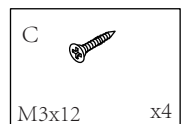
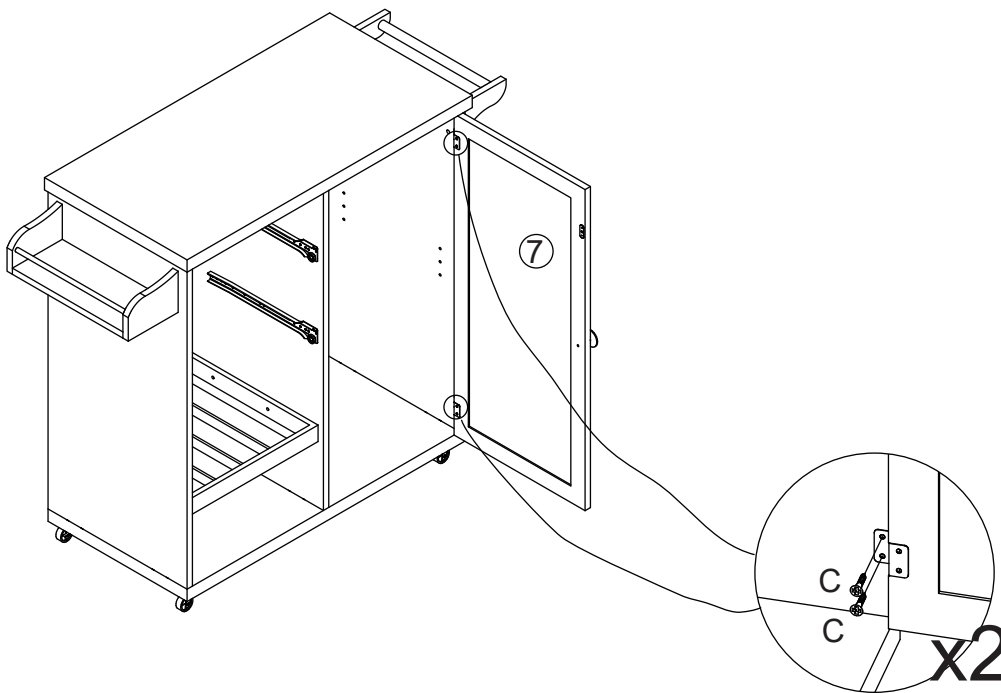

13

U x 8
V x 8

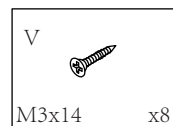
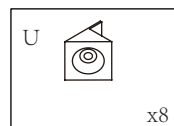
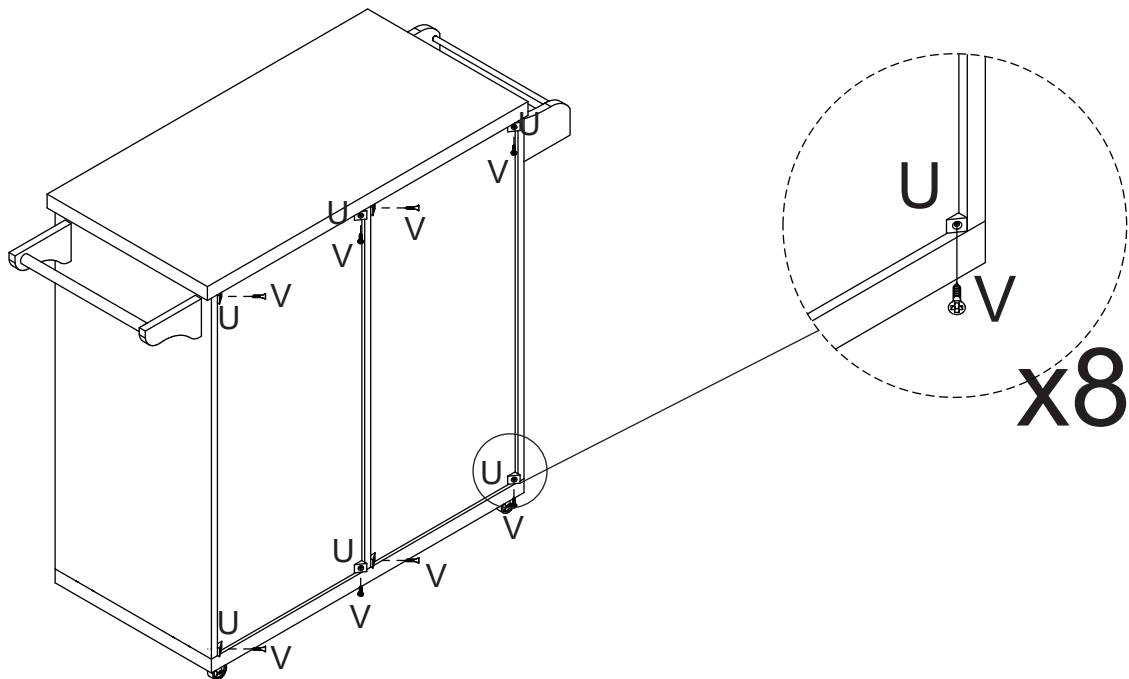

14

