



Item NO.:BV A01130

Hardware

NO.	Description	QTY
A	M4X12 	Screws M4x12mm 12
B		Expansion Bolts 2
C		Screws for fix on the wall M5.5x60 2

Tools

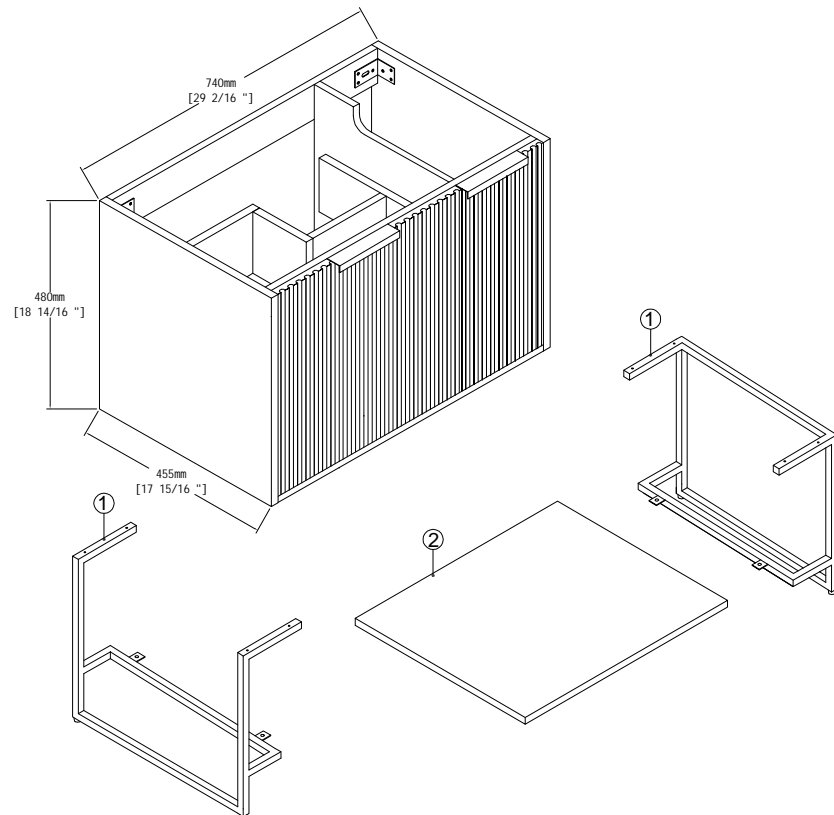
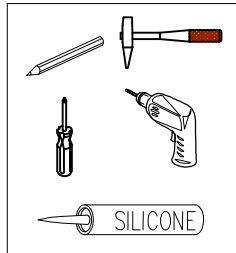

Dimensions

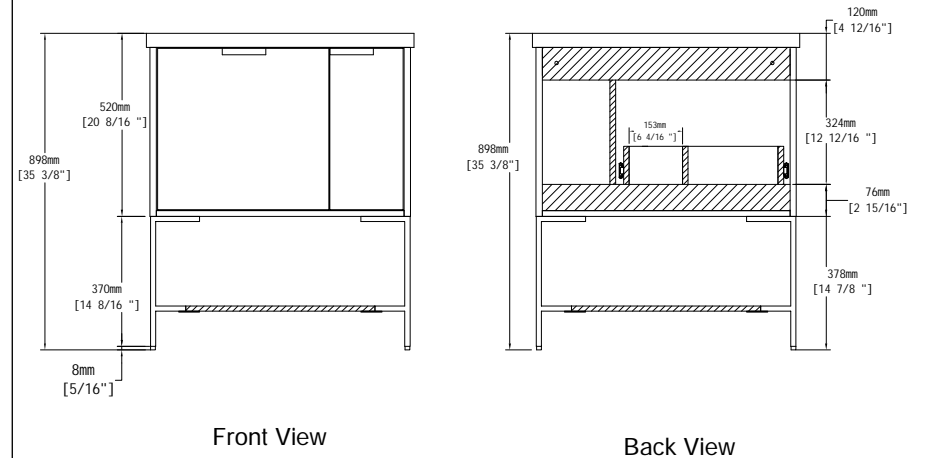

CARE CLEANING AND MAINTENANCE

1. Dust regularly with a soft , dry cloth.
2. Avoid the use of all chemicals household cleaners, abrasives, or cleaners that contain lemon, vinegar, or other acids that may damage the finish.
3. Excessive exposure to sunlight and extreme changes in temperature and moisture can damage wood furniture.
4. The sink top is resilient, but care needs to be taken to preserve its appearance.
5. Do not place hot appliances, such as curling irons and hot hair dryers directly on the countertop. Wipe spills immediately.

Step 5

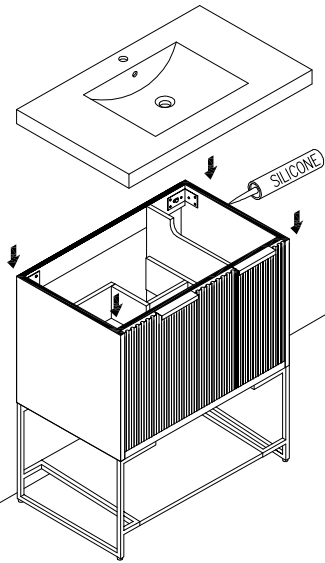

Finished

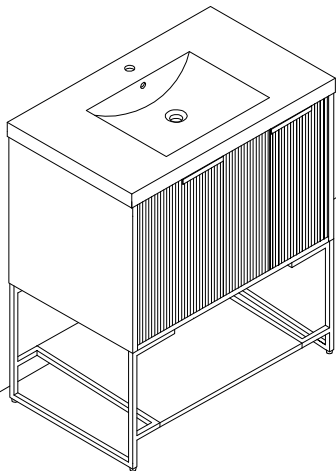

Step 1

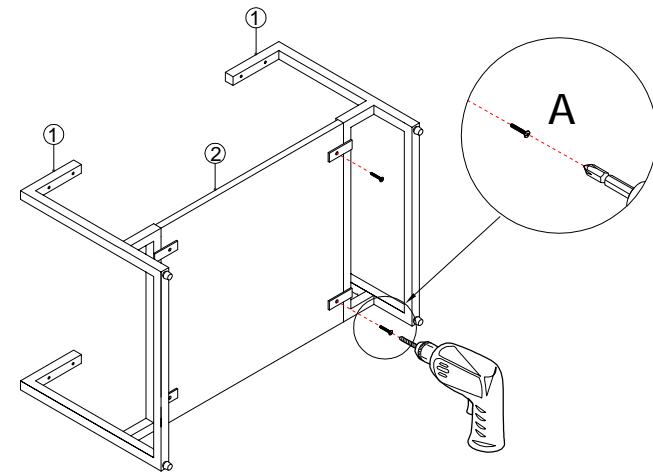
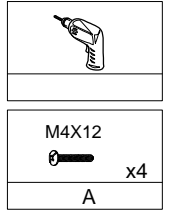
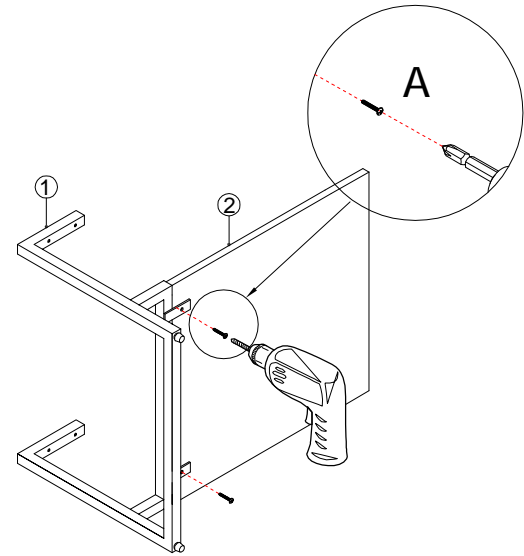

Step 2

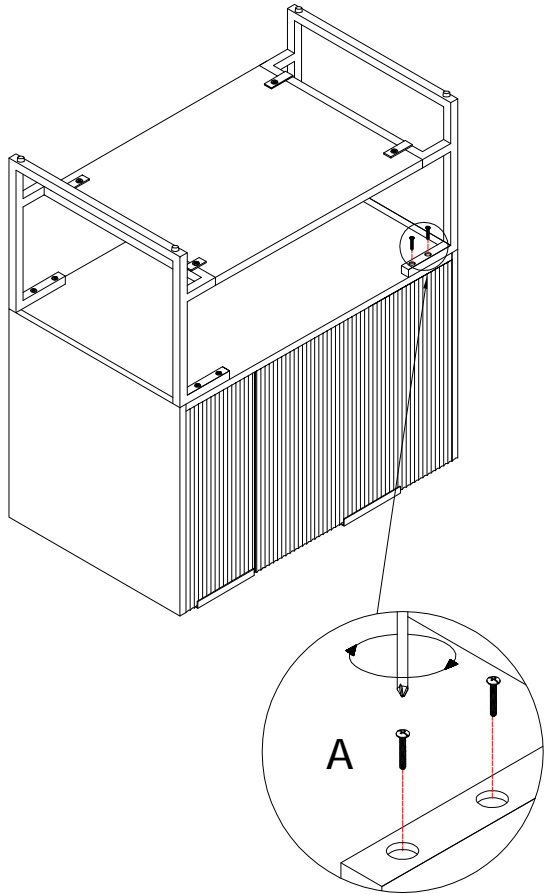
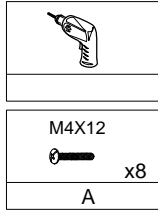

Step 3

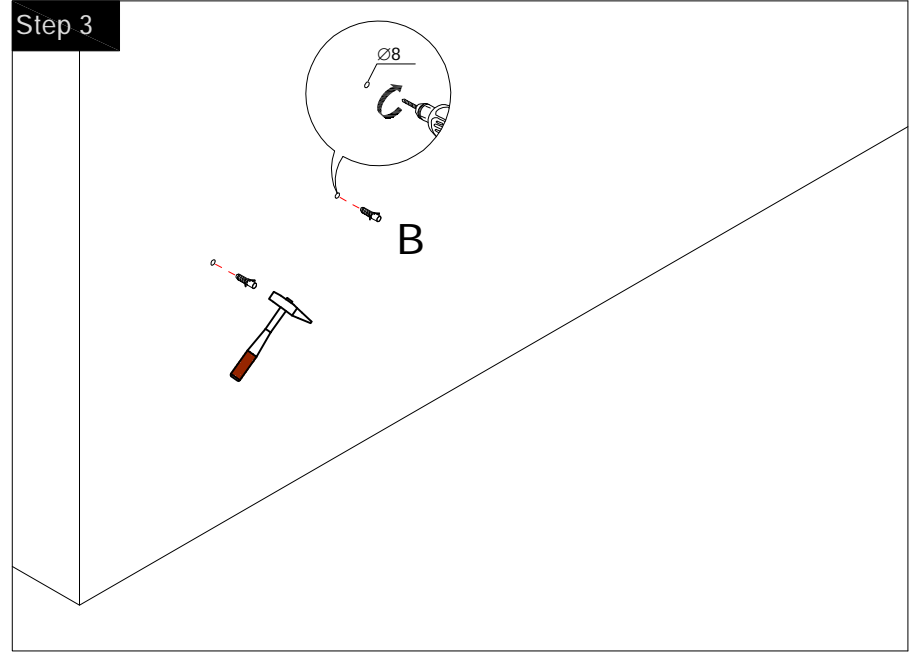

Step 4

