

01

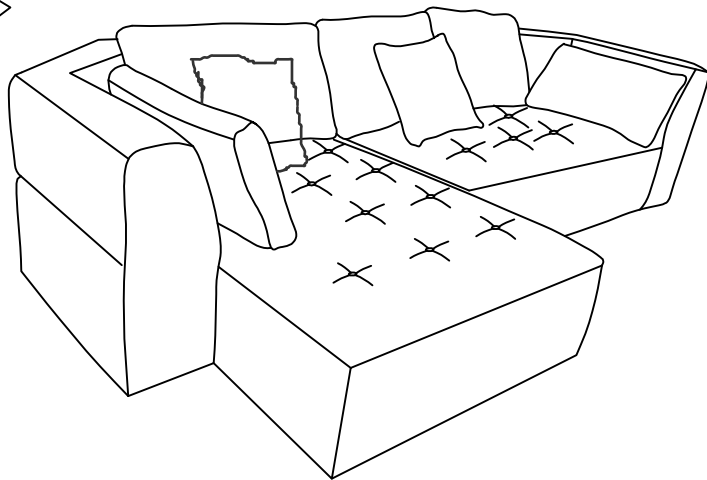

02

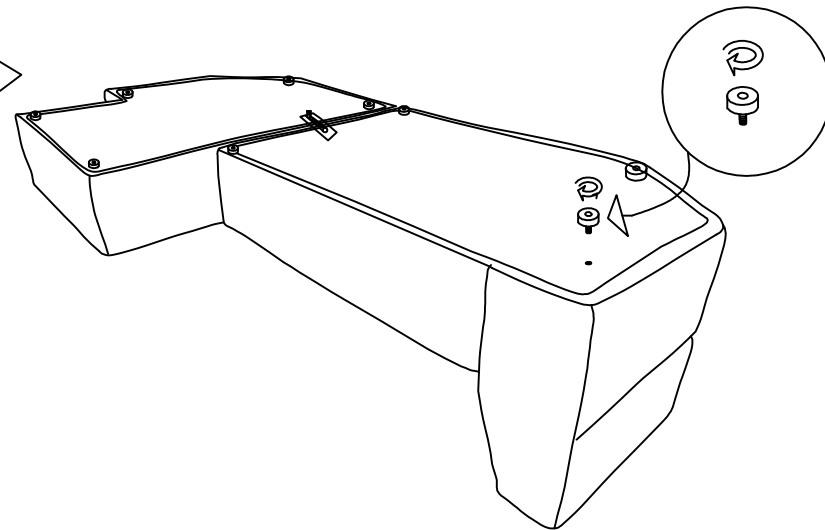

03

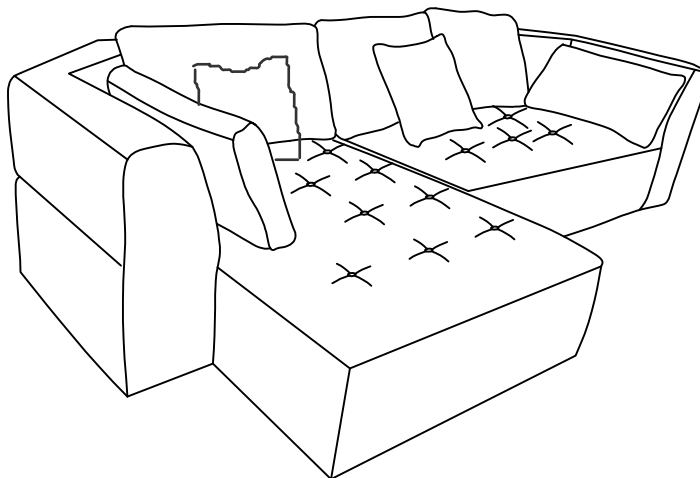

W876S00134

A



9:PCS