

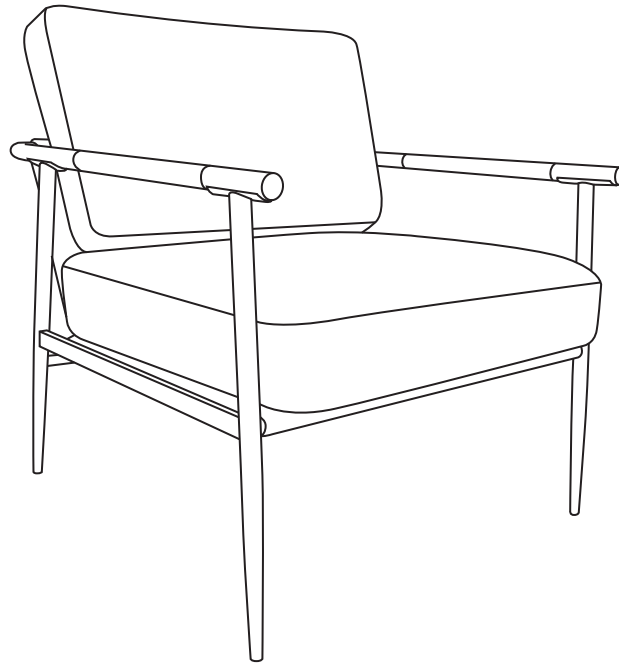

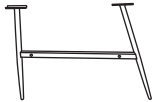











# ASSEMBLY INSTRUCTION

Before you assemble the product, please look through the instruction carefully.

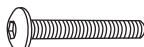

<b>A</b>  2PCS	<b>B</b>  2PCS	<b>C</b>  2PCS	<b>D</b>  2PCS	<b>E</b>  1PC
<b>F</b>  1PC	<b>G</b>  1PC	<b>H</b>  1PC	<b>I</b>  1PC	<b>J</b>  1PC
<b>K</b>  1PC	<b>L</b> M6×45mm  8PCS	<b>M</b> M6×20mm  10PCS		

1

<b>L</b>	M6×45mm	<b>K</b>
		
4PCS		1PC

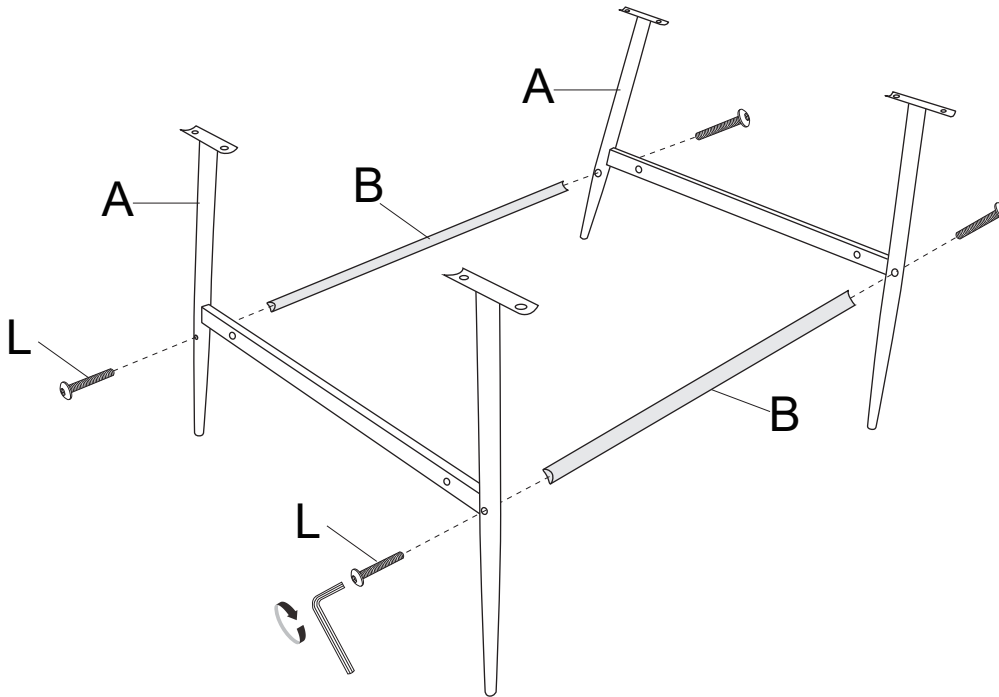



- Put the frames (A) together , assemble with tube (B).

2

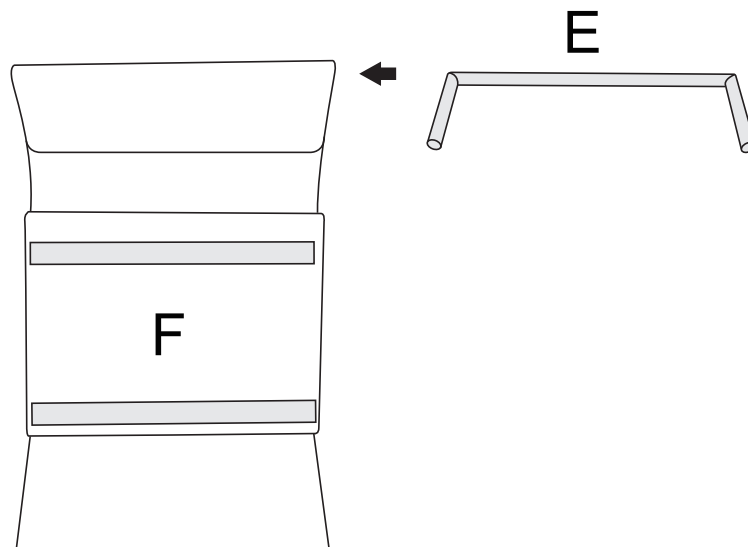
- Put the stretcher “E” through the backrest.



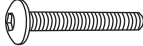

**3**

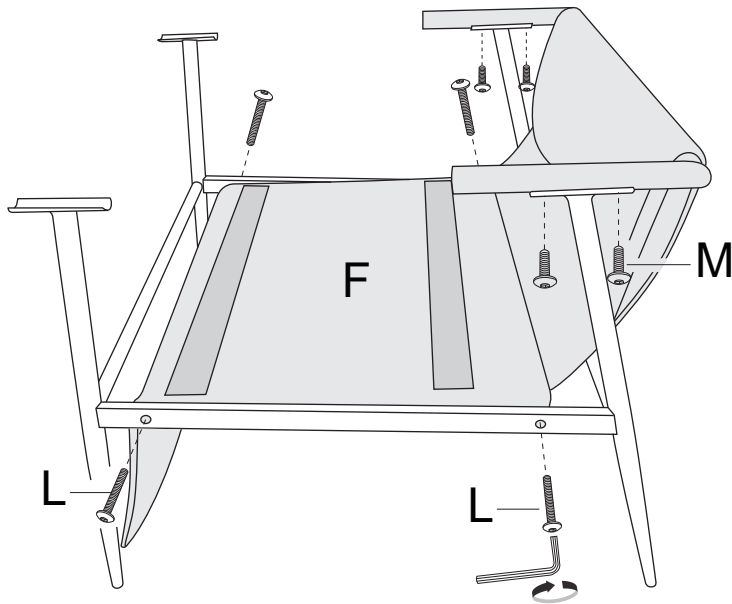
<b>L</b>	M6×45mm	<b>M</b>	M6×20mm	<b>K</b>
				
4PCS		4PCS		1PC



- Assemble the backrest stretcher (E) with chair frame with screws (M).
- Secure backrest (F) on the chair frame. Align the metal tube inside the chair seat with the screw holes in chair sides, screwed with screws (L).

**4**

<b>M</b>	M6×20mm	<b>K</b>
		
6PCS		1PC

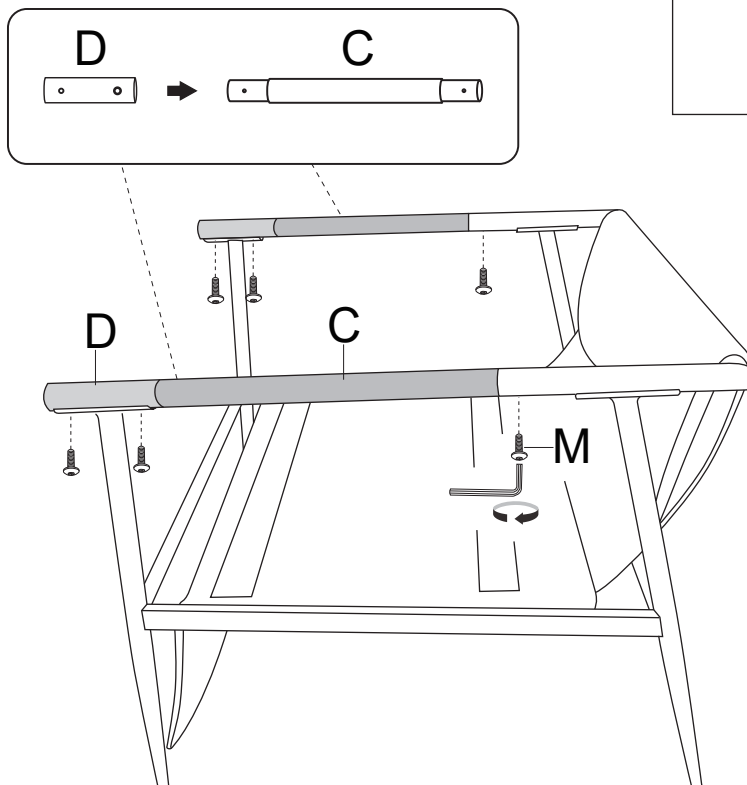

- Assemble armrests (D) and (C) with screws (M).

5

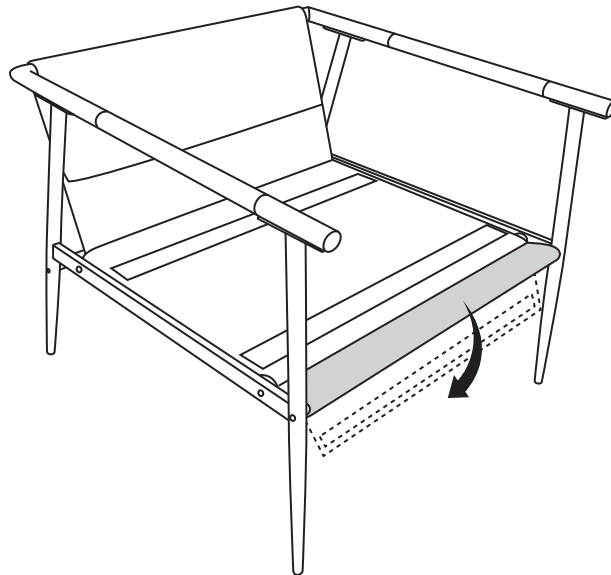

- Stick the seat end to the bottom of the chair seat.

6

- The cushion is packaged by vacuum compression. After cutting the package, it rebounds quickly within 4 hours. If the fabric has wrinkles, it will basically disappear after standing for 72 hours.

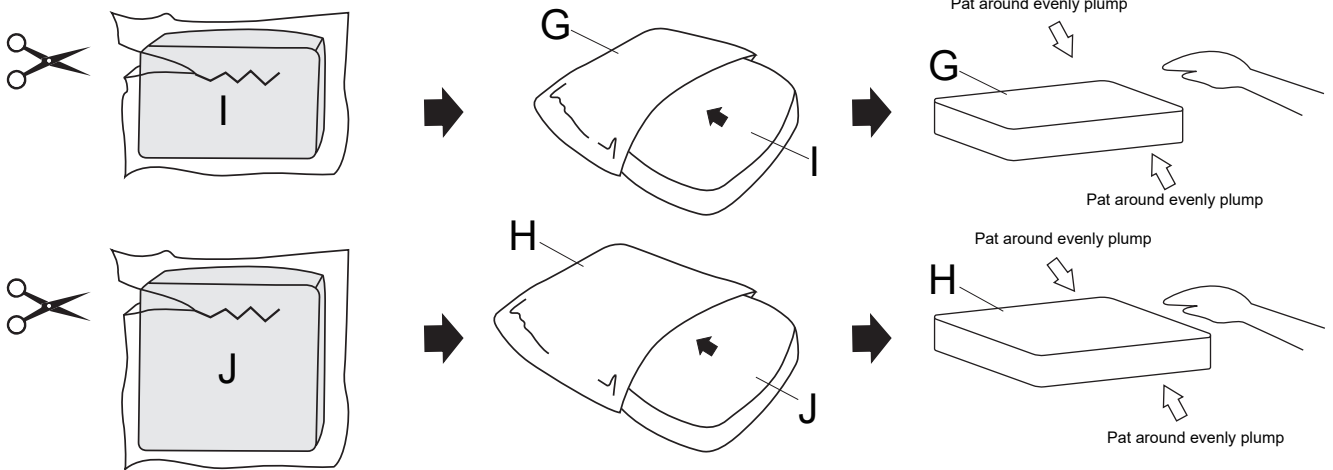

7

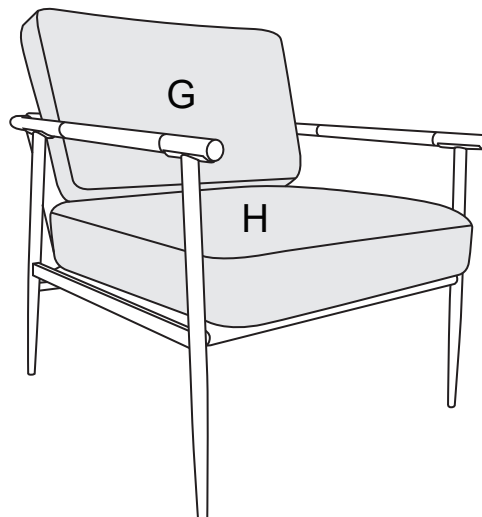

- Place Seat cushion (H) and back cushion (G) on chair frame and make sure it's will fitted.