

Installation Instruction

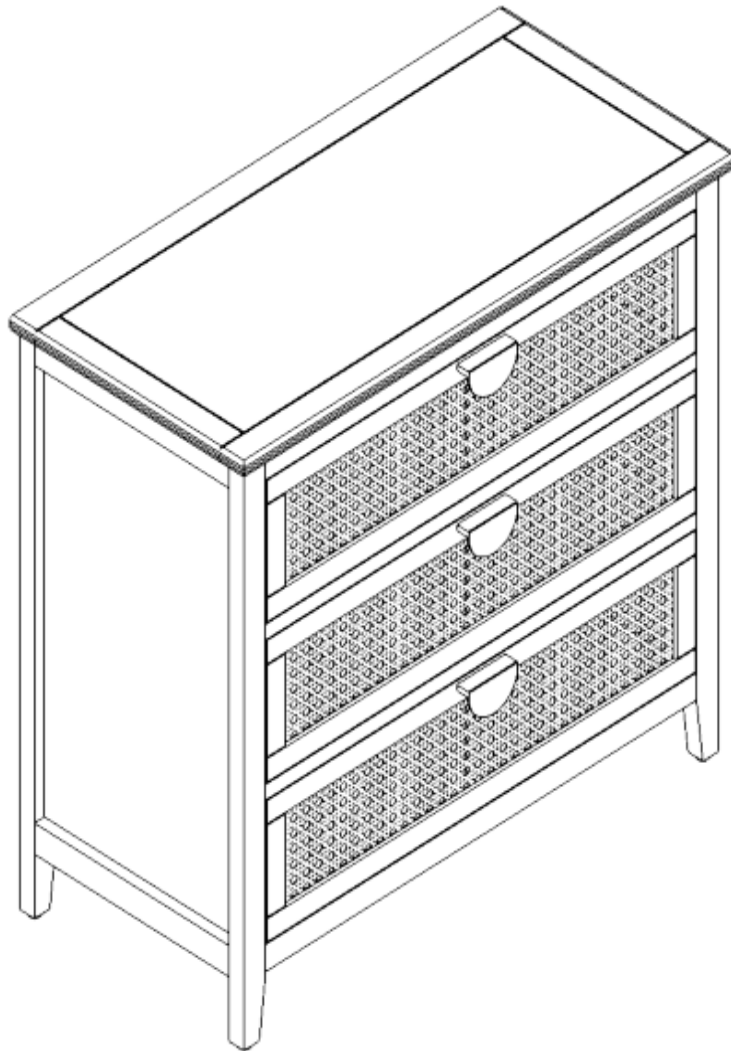

W68858063

Assembling

Estimated time for assembly



25 : 00

What you need

.Use the packaging carton as a working surface to prevent product damage during assembly

.Phillips head screwdriver

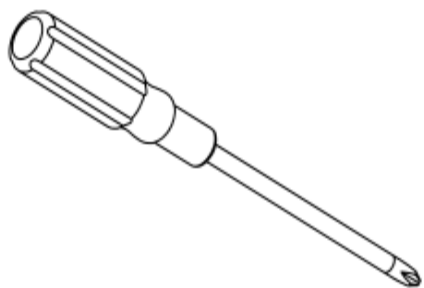

Weight Limitation



55

lbs table top

5

lbs per shelf

What's included

Code	Description	Qty
A	Cam Bolt M5*27mm	15
B	Cam Lock 15*10mm	15
C	Screw Φ 4x25mm	17
D	Handle	3
E	Bolt M4*18mm	6
F	Bolt M6x35mm	8
G	Metal Washer M6.5x1.2mm	8
H	Allen Key	1
I	Screw Φ 4x20mm	4
J	Screw Φ 4x16mm	4
K	Plastic corner support	8
L	Screw Φ 2.5x16mm	8
M	Nylon strap	2
N	Anchor	2

The Hardwares

A



B



C



D

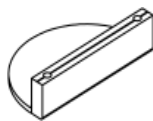

E



F



G



H



I



J



K



L



M

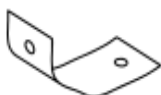

N



IMPORTANT:

1. Do not tighten bolts / screws completely until all bolts / screws are lined up and inserted into holes.
2. Do not over tighten screws and bolts to avoid stripping.
3. Please use hand tools to assemble this product. Do not use power tools.

Included Accessories

Code	Description	Qty
1	Drawer Front Panel	3
2	Drawer Left Side Panel	3
3	Drawer Right Side Panel	3
4	Drawer Vertical Stretcher	3
5	Drawer Bottom Panel	3
6	Drawer Back Panel	3
7	Bottom Panel	1
8	Left Side Panel	1
9	Drawer Bottom Support Panel	2
10	Right Side Panel	1
11	Back support Panel	1
12	Back Panel	2
13	Cabinet Top	1

The Accessoriess

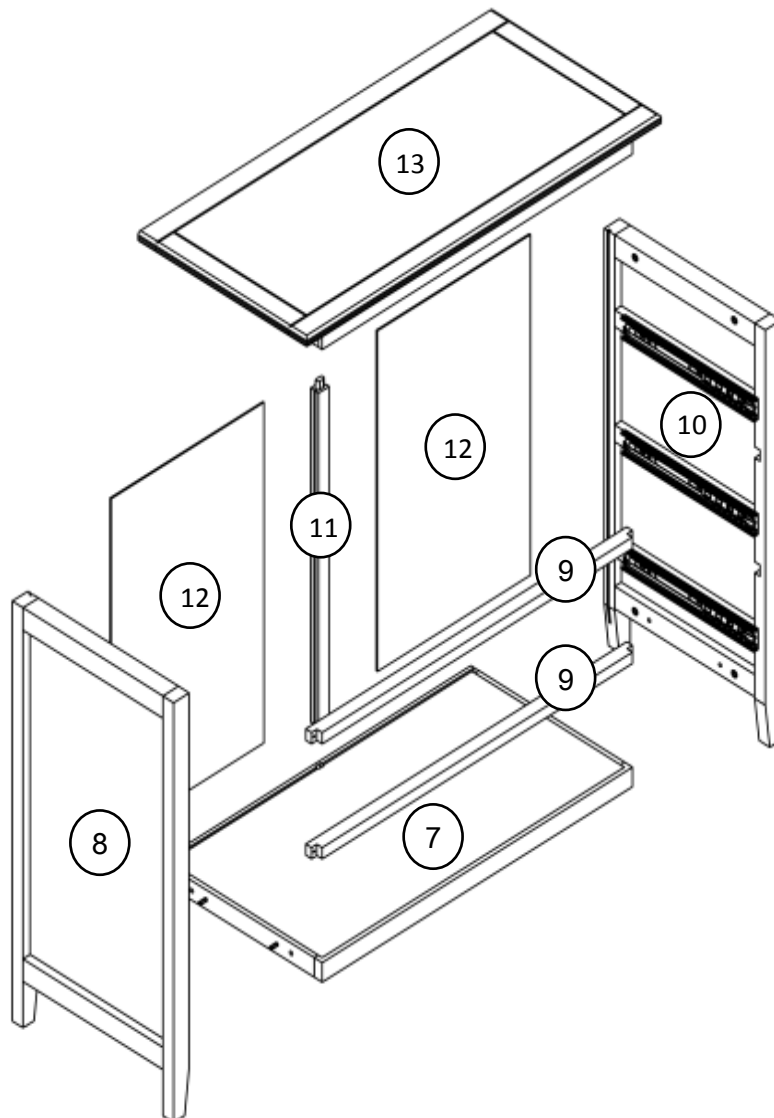
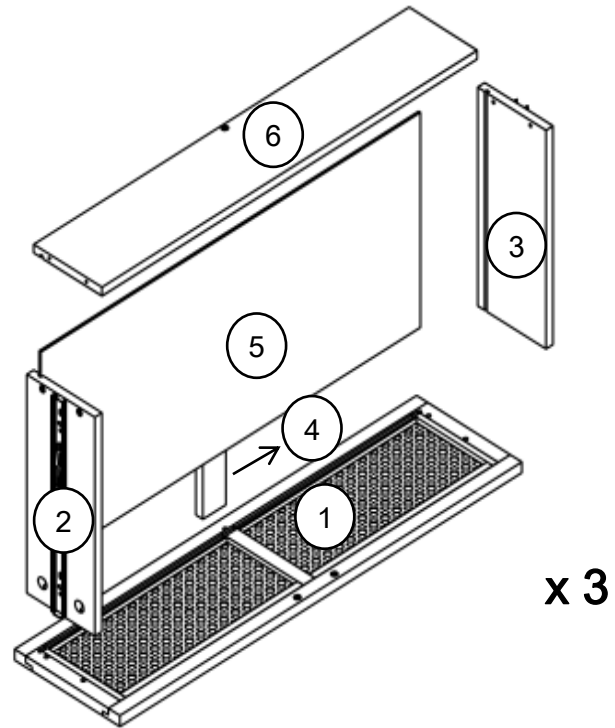

Step 1

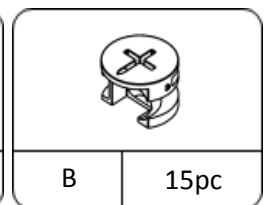
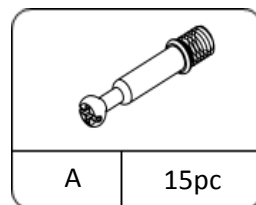
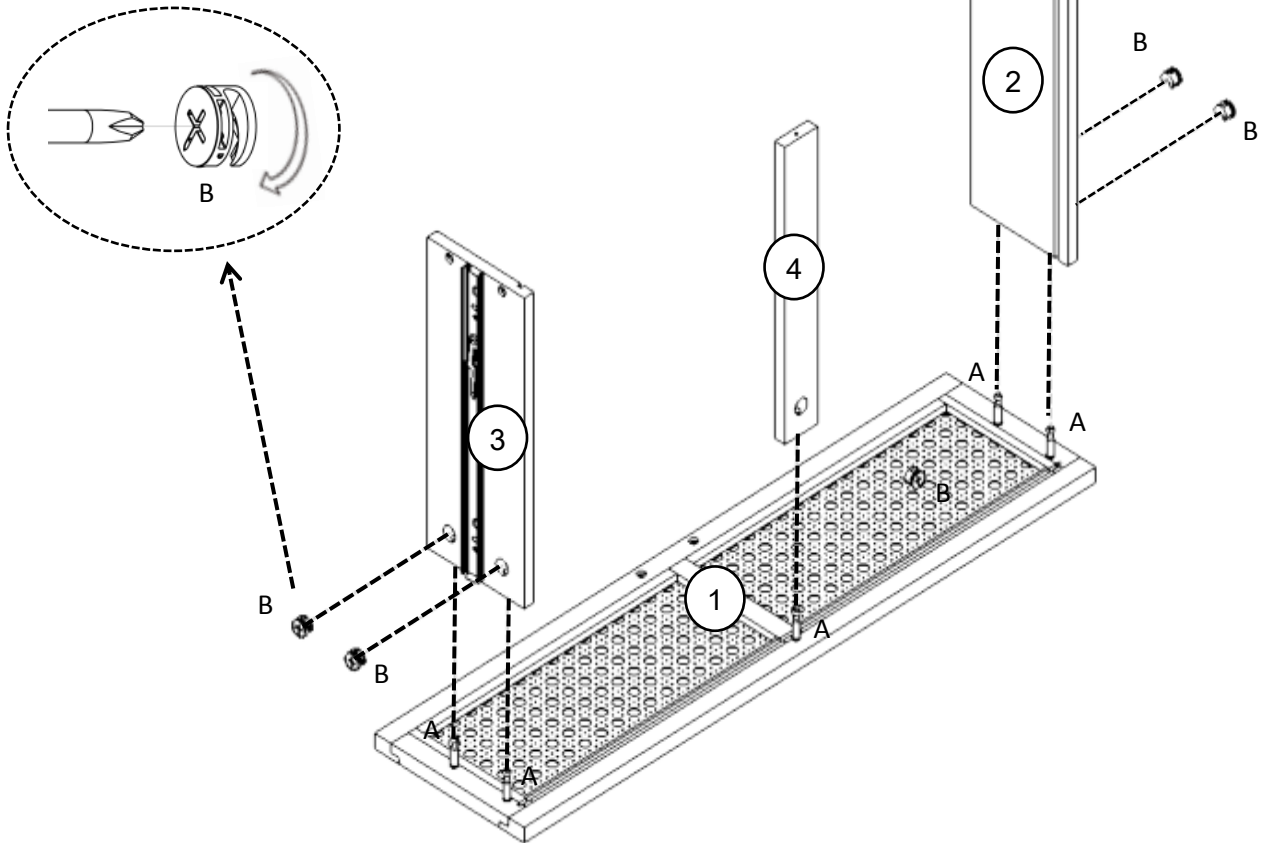
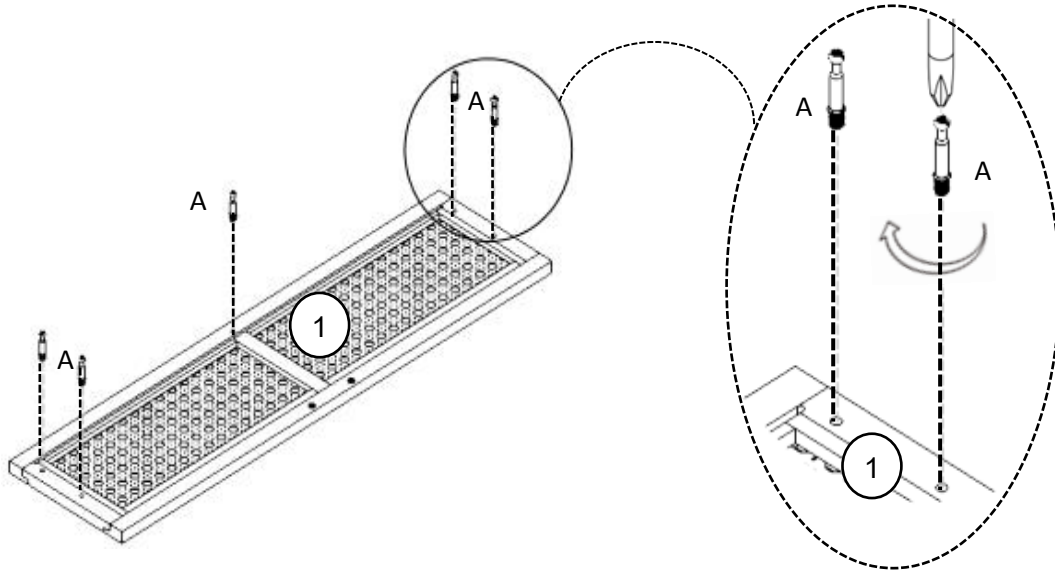

Step 2

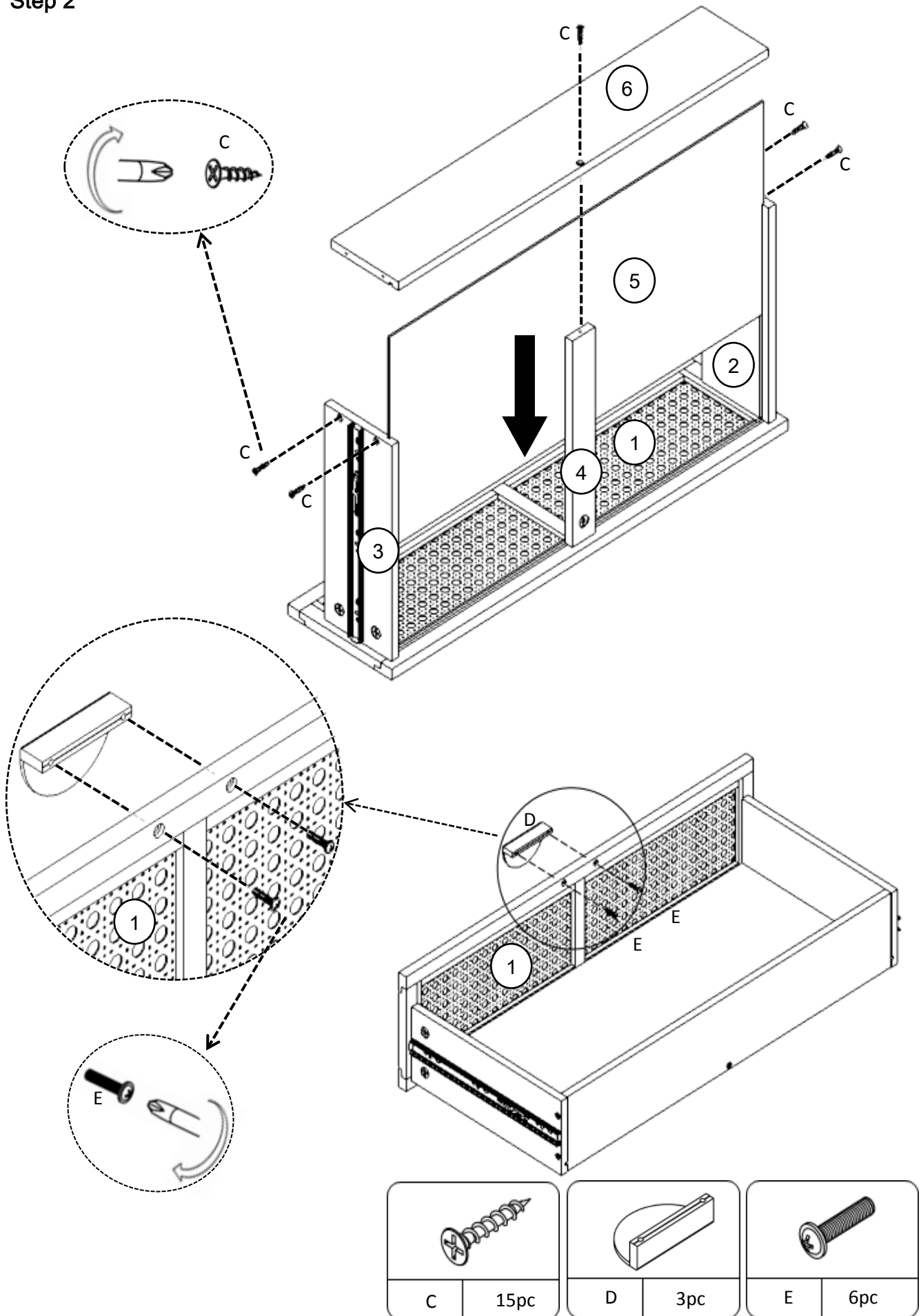

Step 3

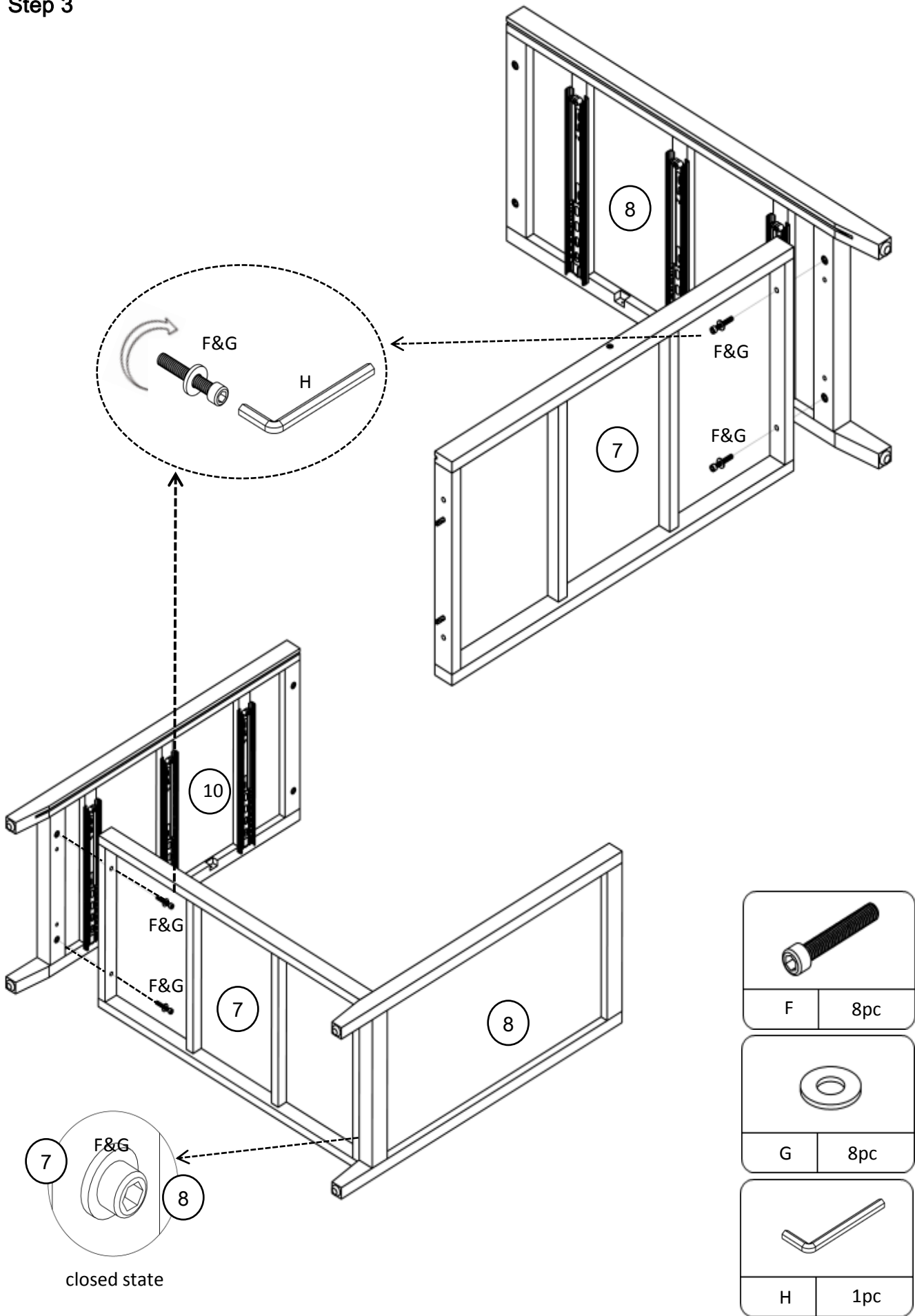

Step 4

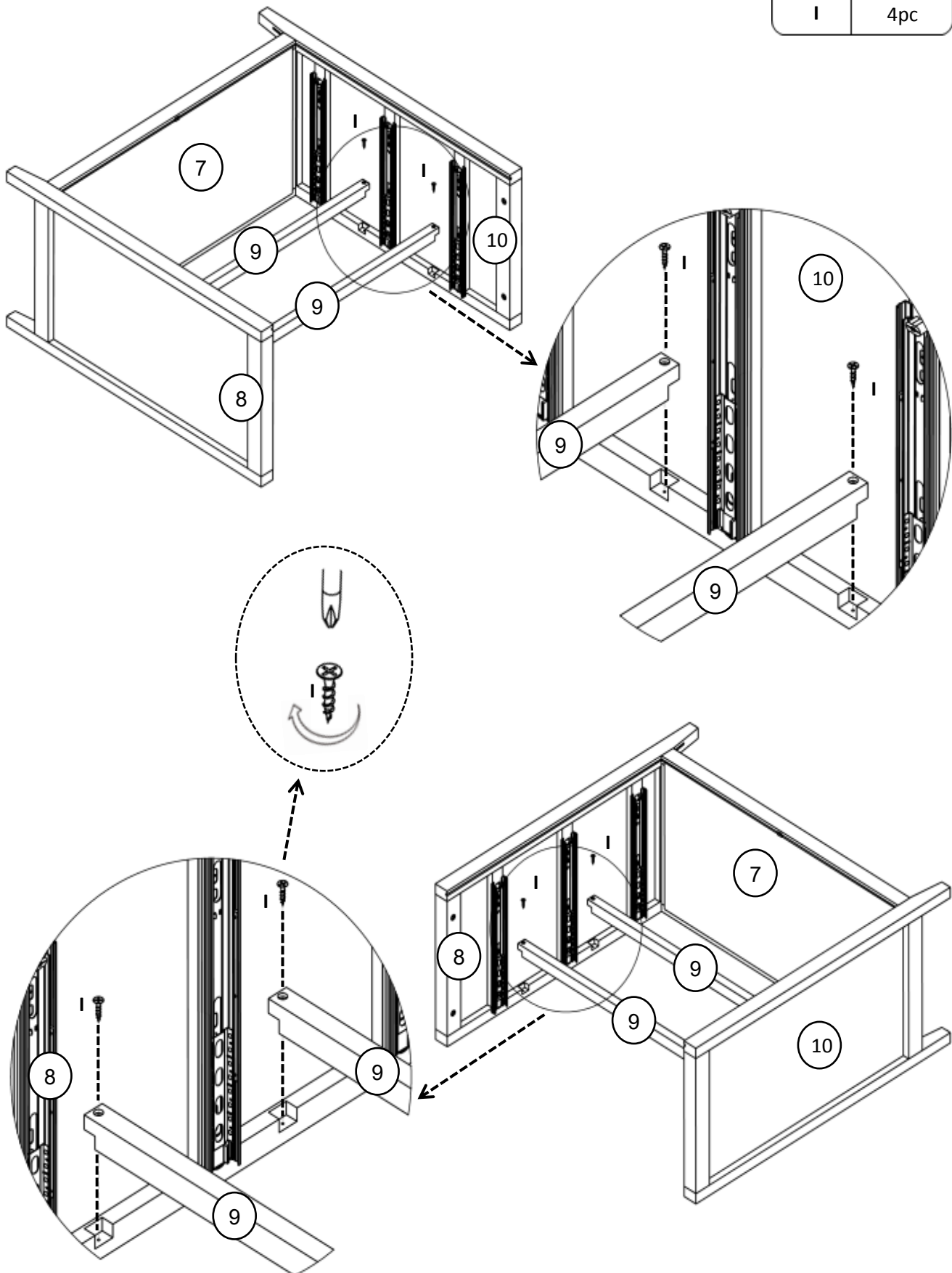
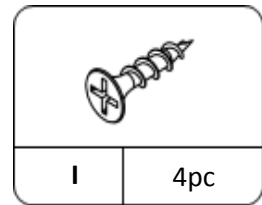

Step 5

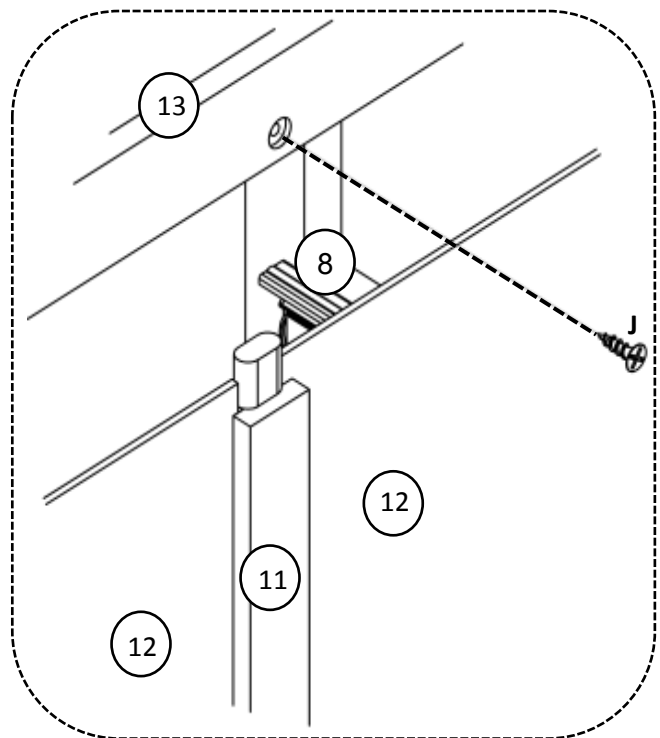
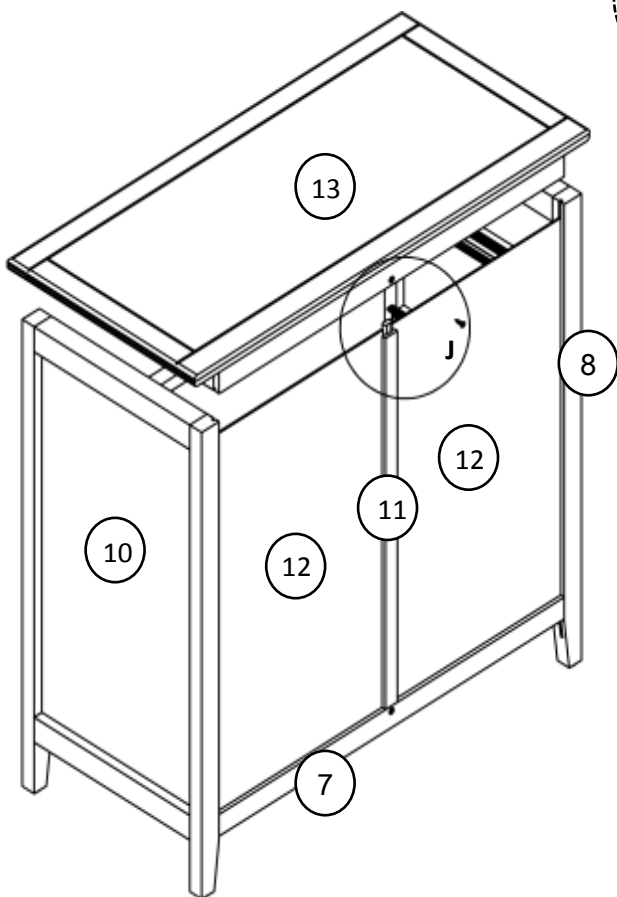
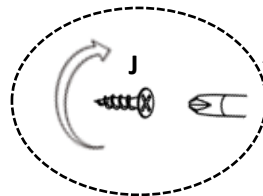
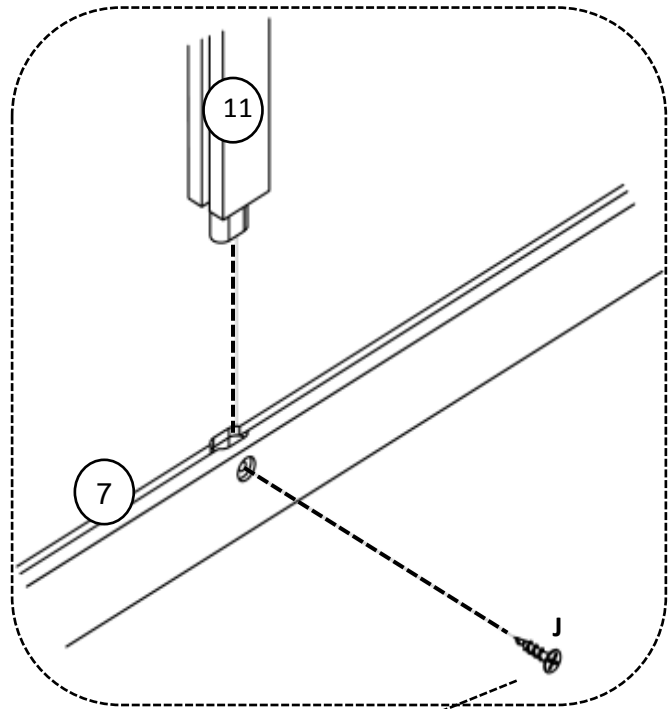
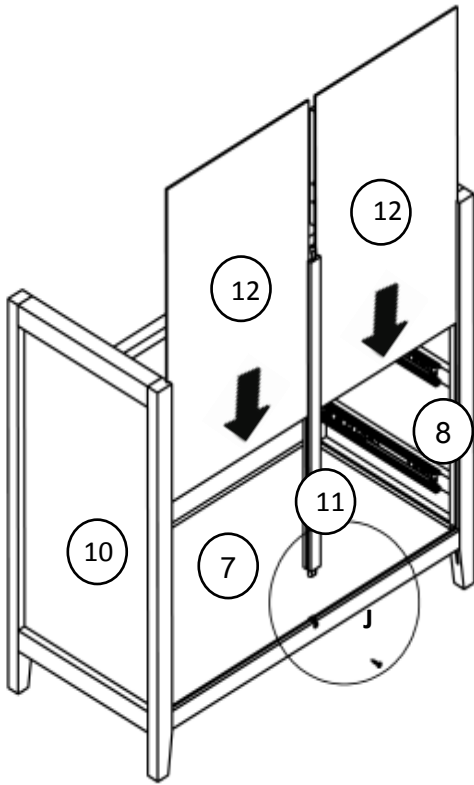
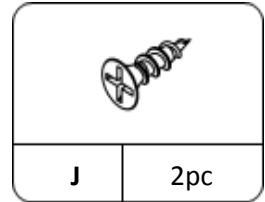

Step 6

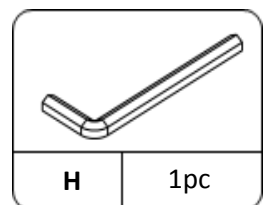
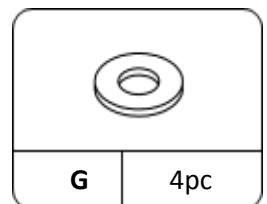
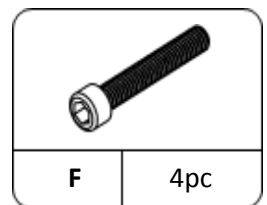
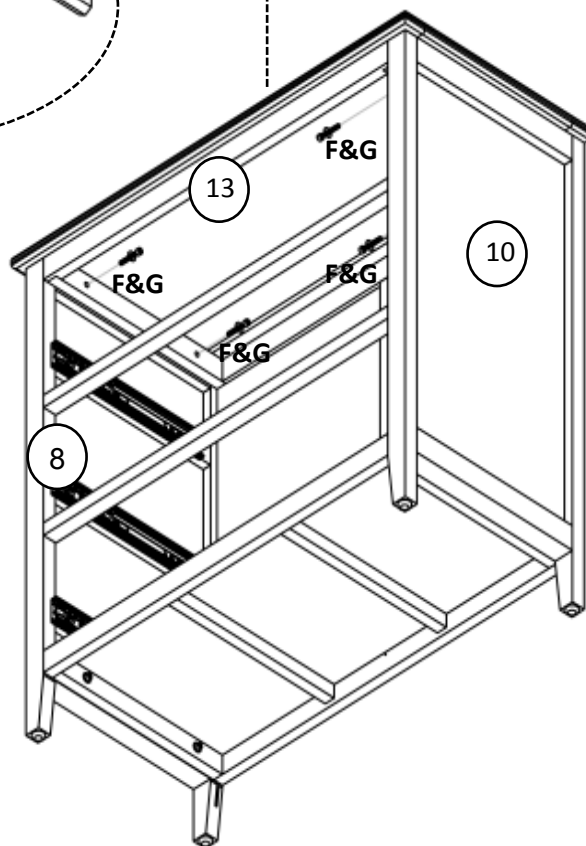
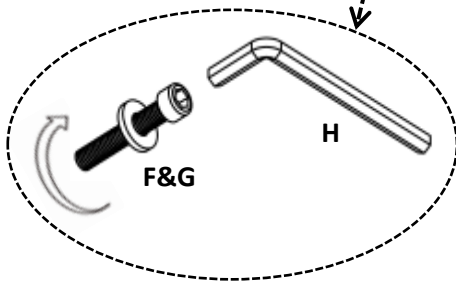
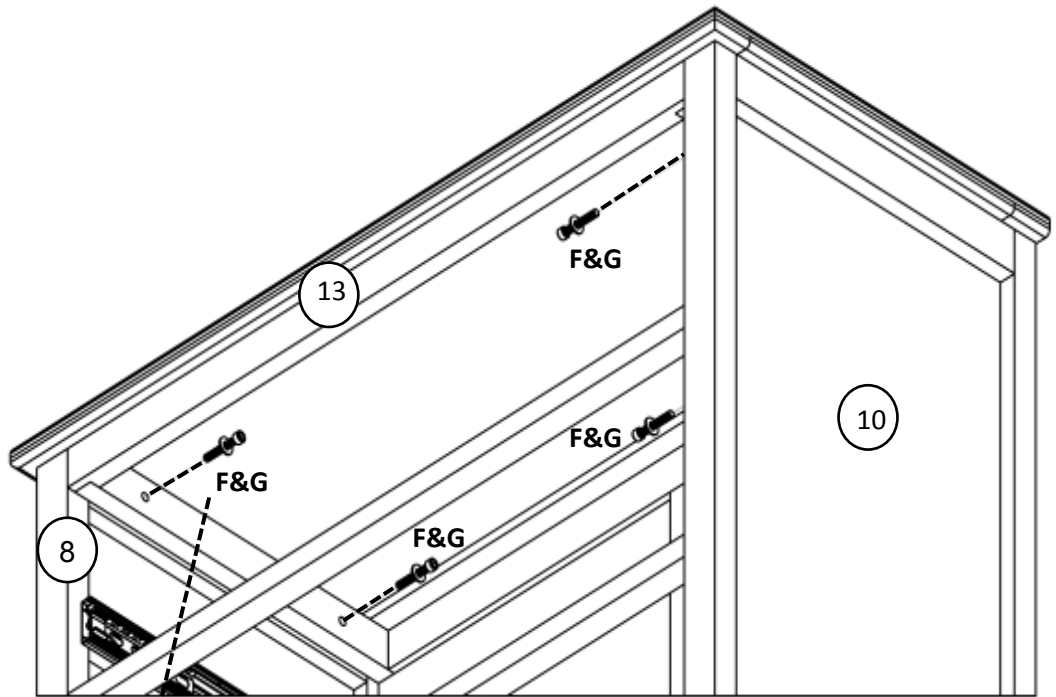

Step 7

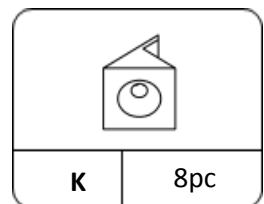
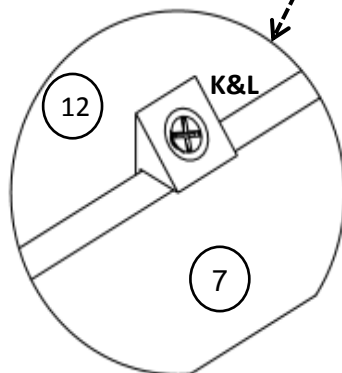
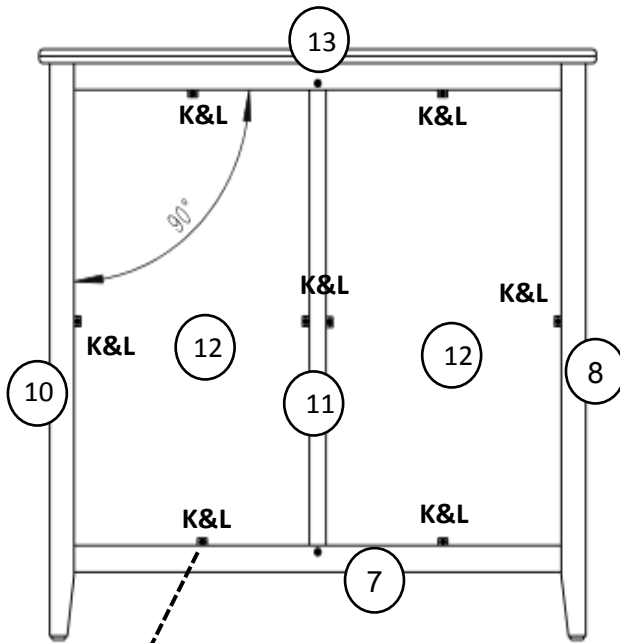
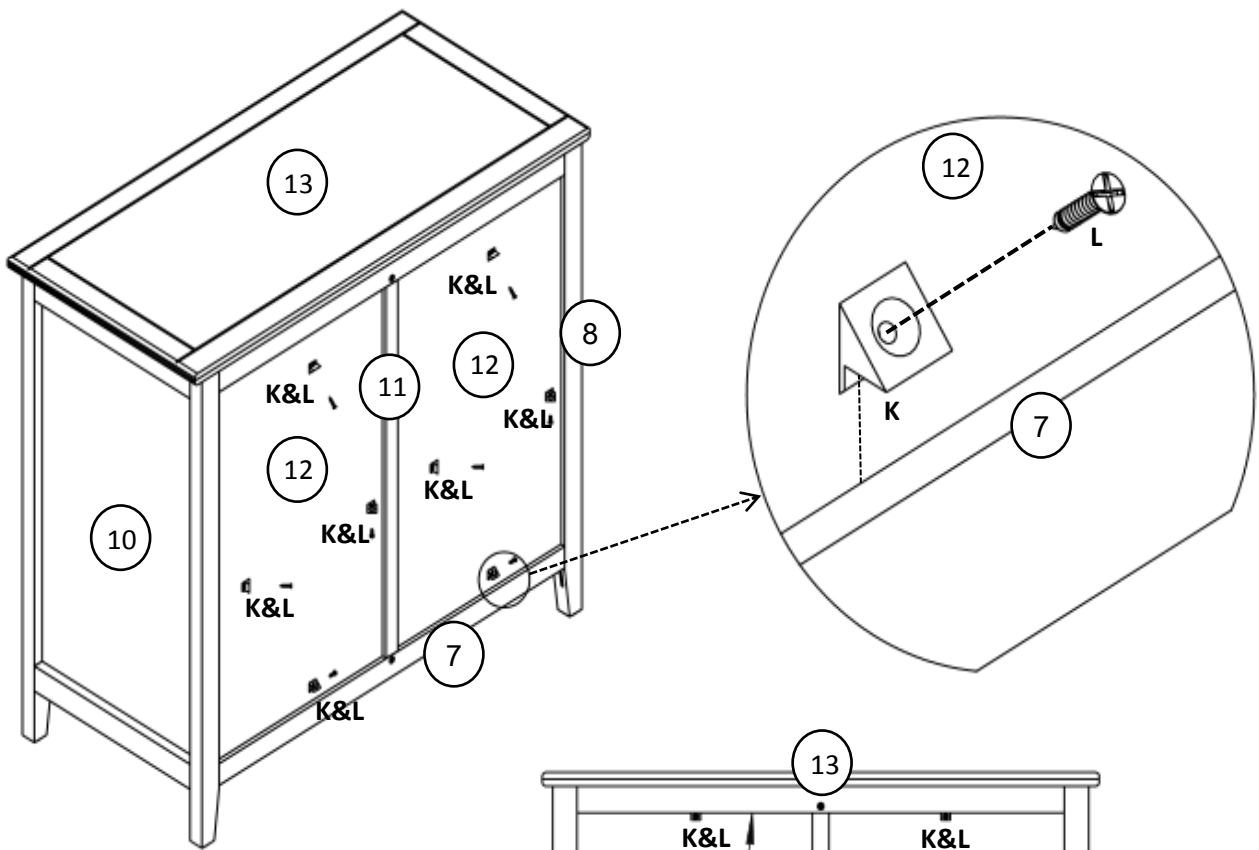

Step 8

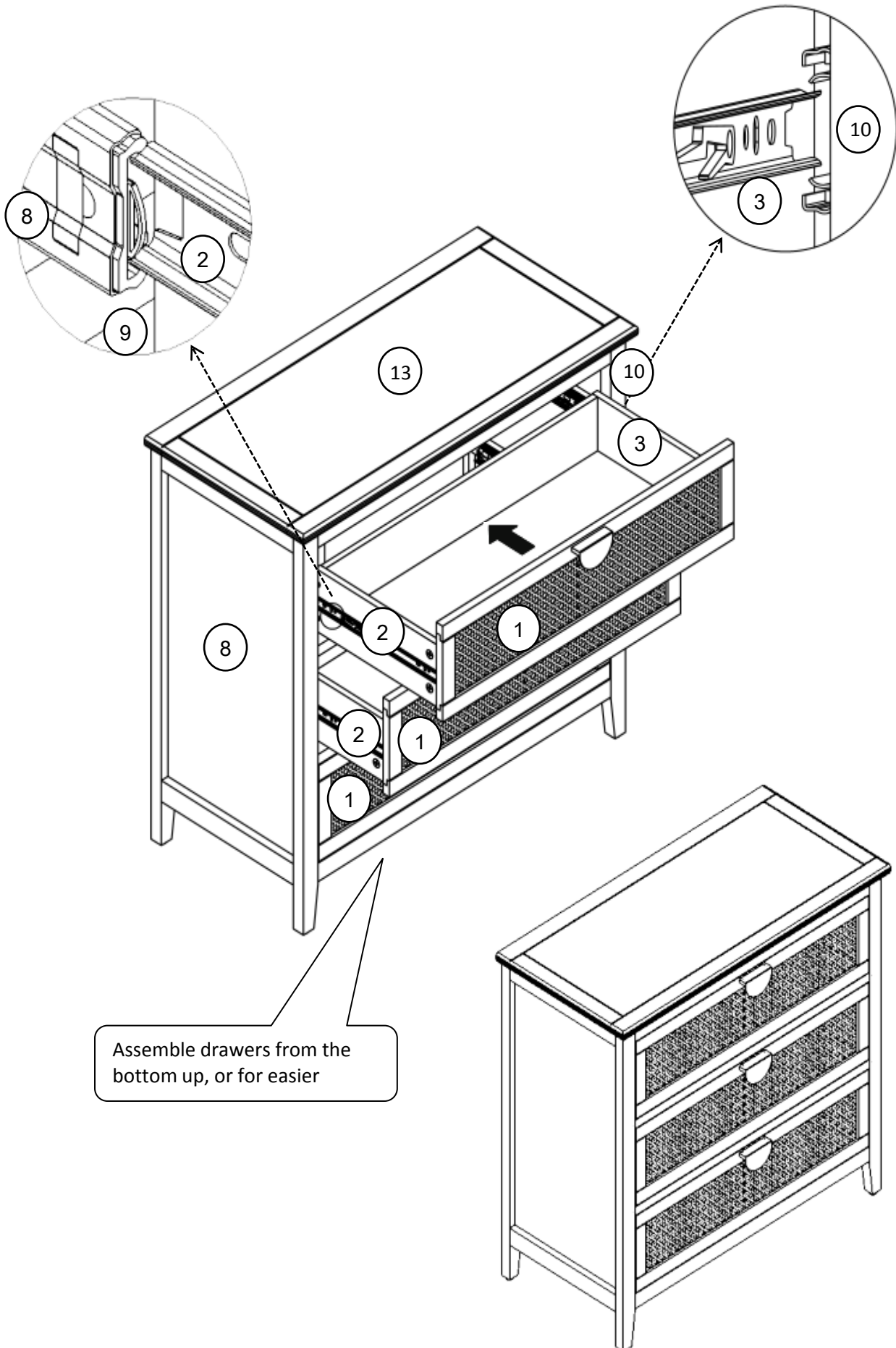

Step 9

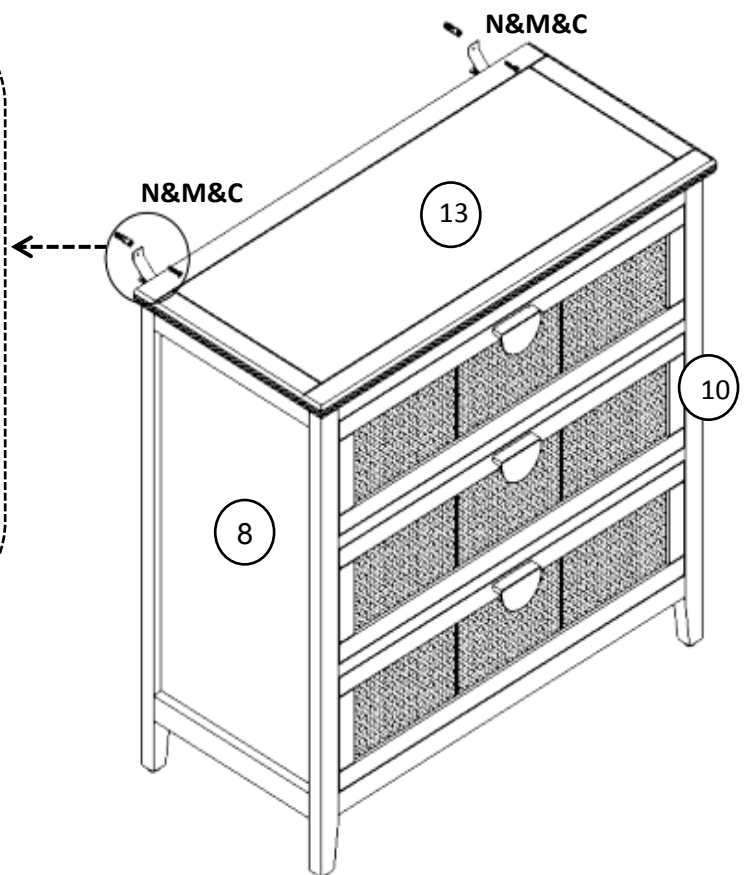
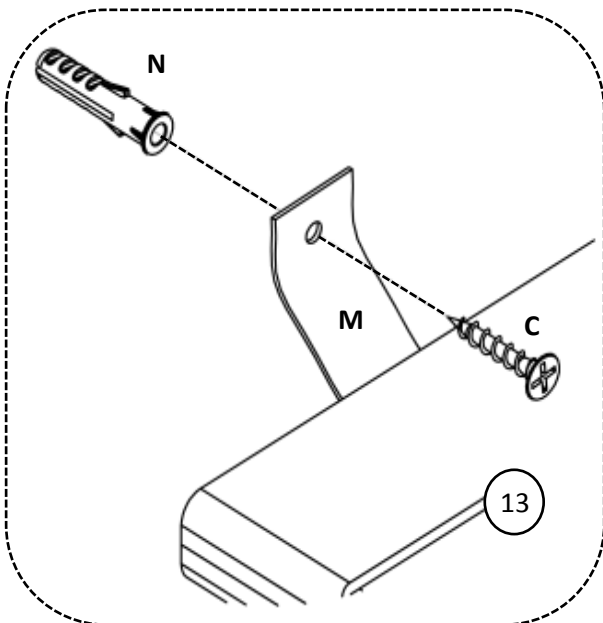
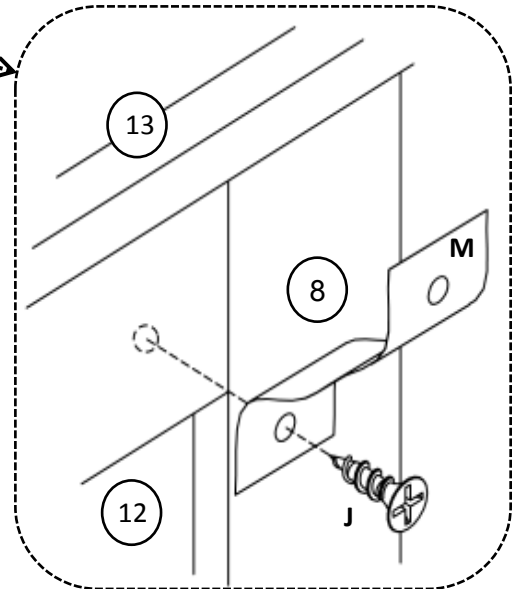
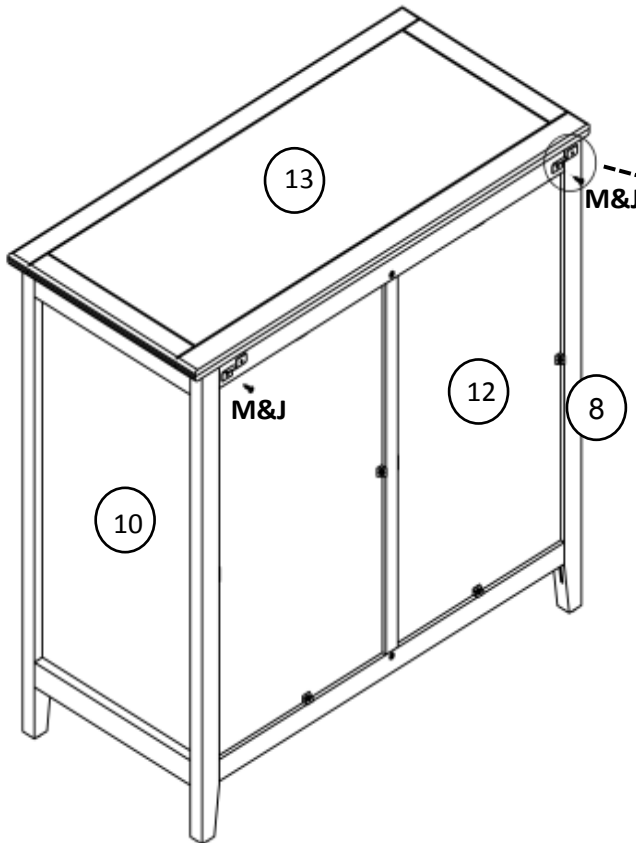
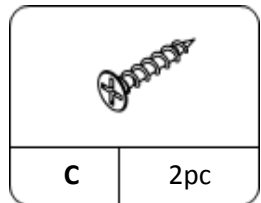
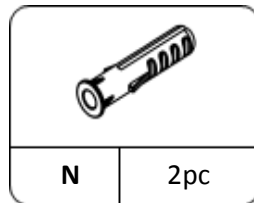
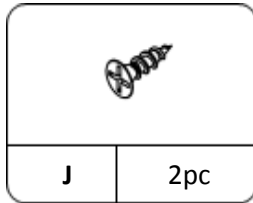
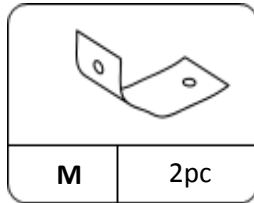

Proper Use

- DO NOT use for commercial purposes
- DO NOT use as a step stool or stand on table
- DO NOT put hot serving liquid directly on the table top
- DO NOT leave spilled liquid on the table top
- DO NOT use table if damaged
- DO NOT exceed weight limit
- DO NOT make temporary repairs
- DO NOT use outdoor