

C x 10

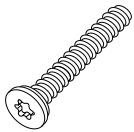

M6x45 mm

G x 10



M6/10 mm

J x 20



Ø6/Ø14 mm

K x 1

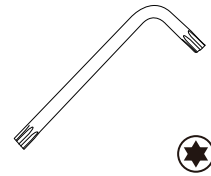

T25/T30

L x 1



10/13 mm





N x 10

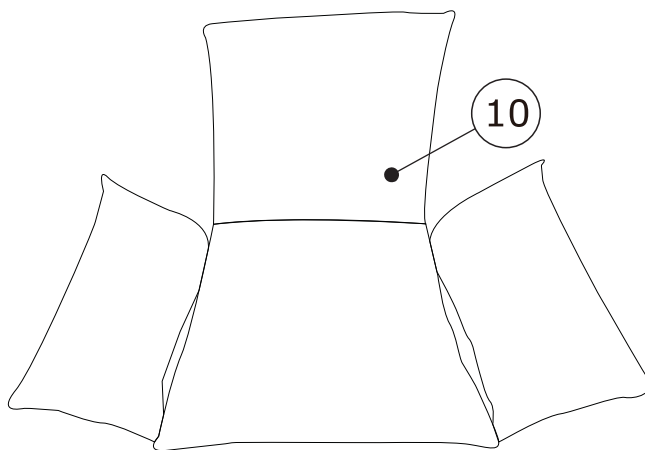
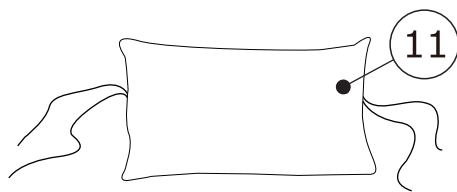
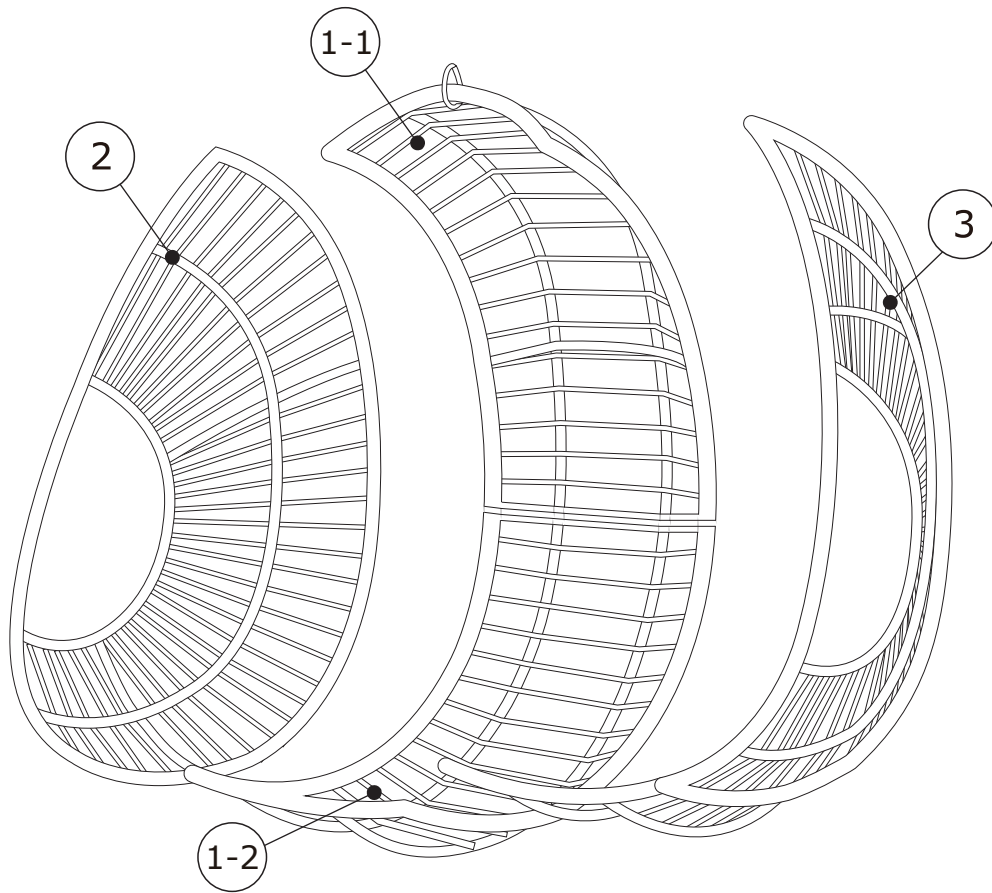

Ø15 mm



1

C x 10  M6x45 mm	G x 10  M6/10 mm	J x 20  Ø6/Ø14 mm	K x 1  T25/T30	L x 1  10/13 mm	
---	---	--	--	--	--

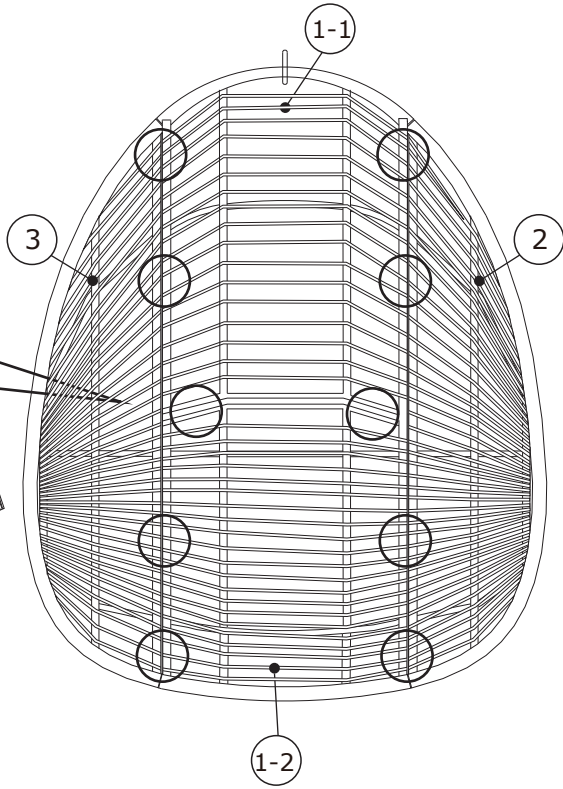
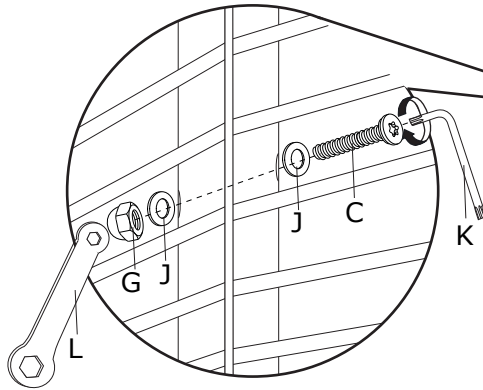
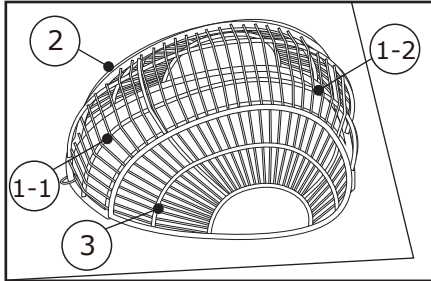
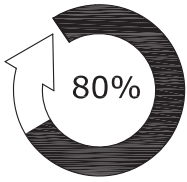

2

<p>K x 1</p>  <p>T25/T30</p>	<p>L x 1</p>  <p>10/13 mm</p>	
---	--	--

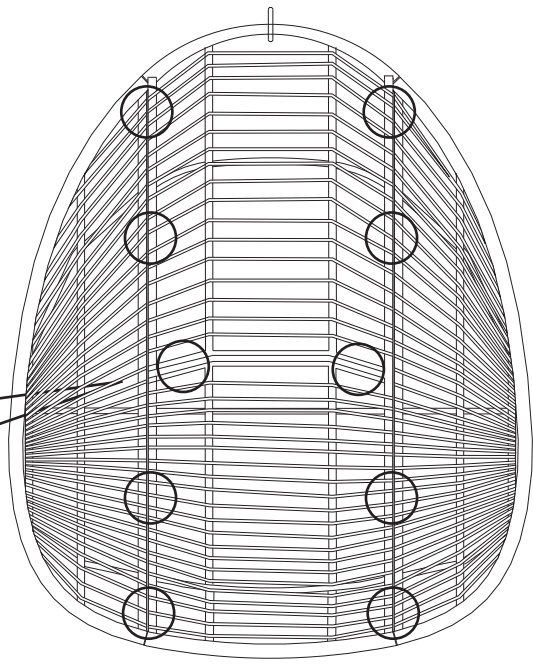
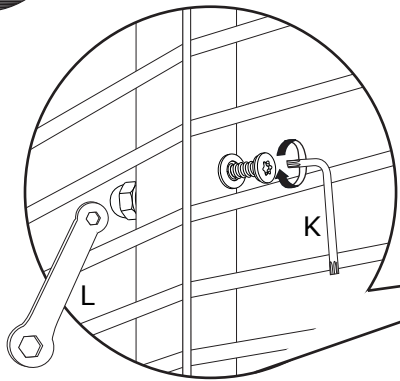
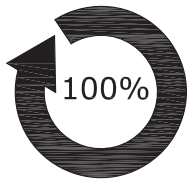

3

<p>N x 10</p>  <p>Ø15 mm</p>	
---	--

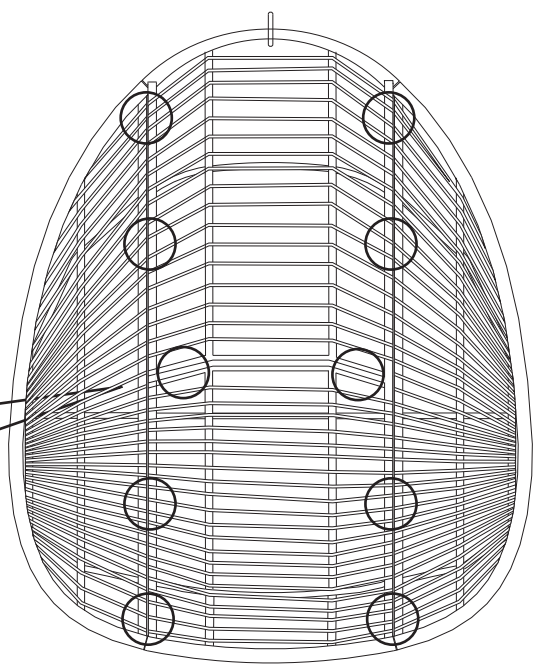
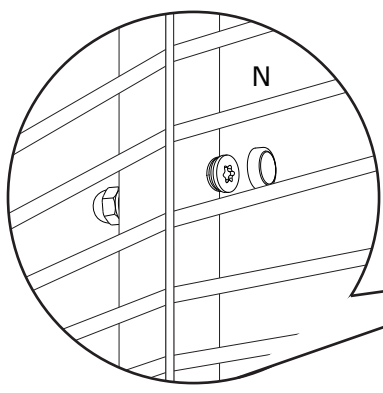

4

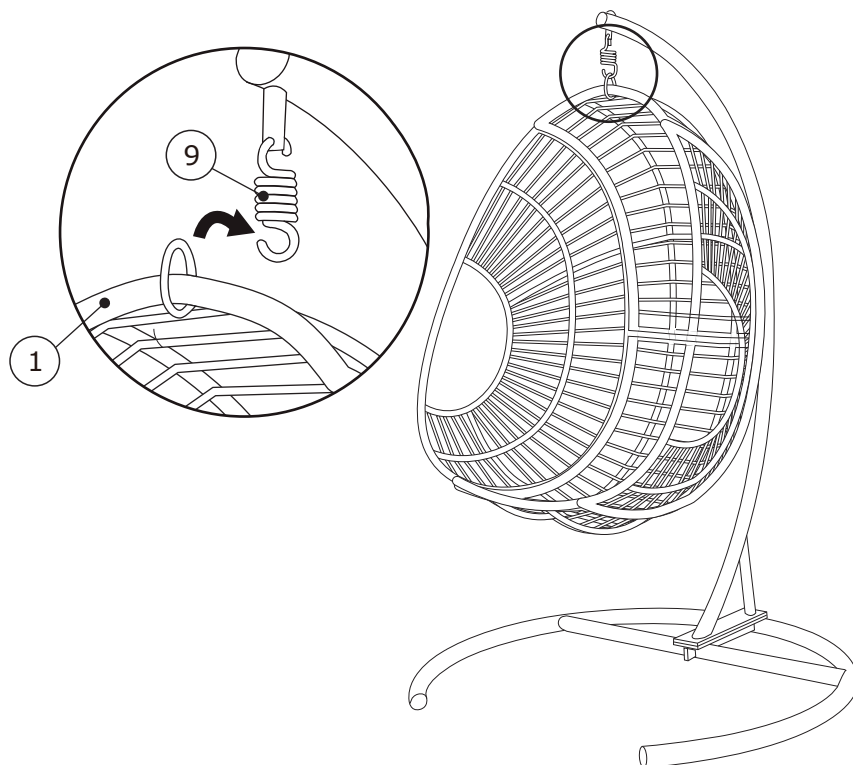

5

<p>P x 6</p>  <p>49x45x27 mm</p>	
---	--

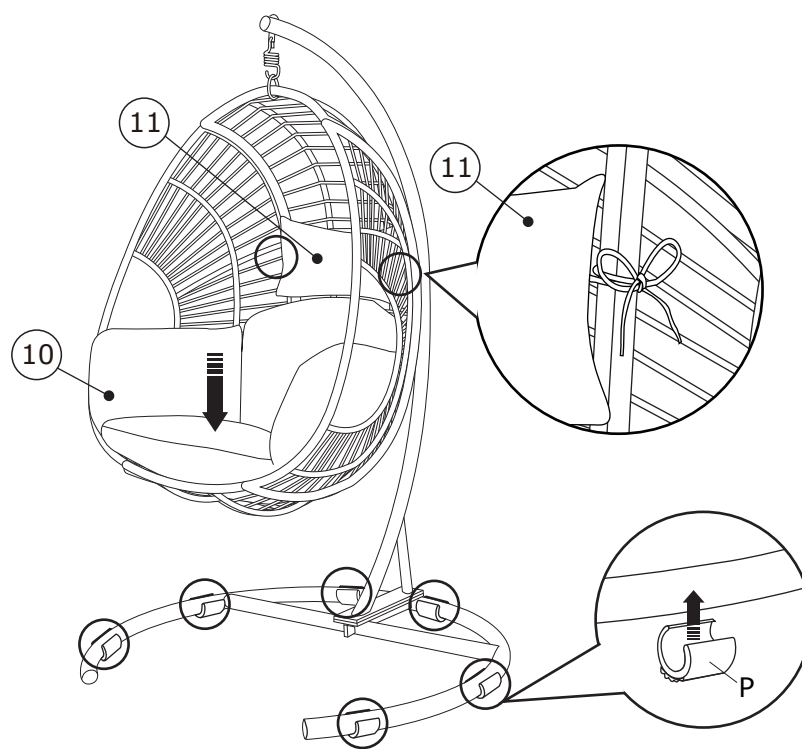

6

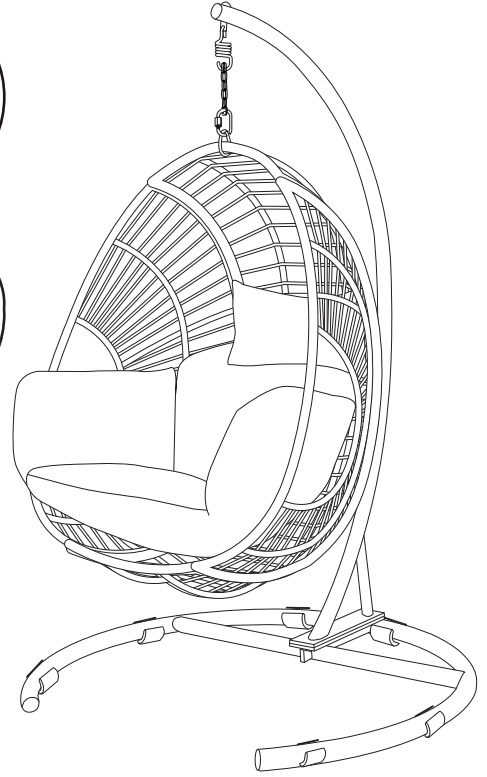
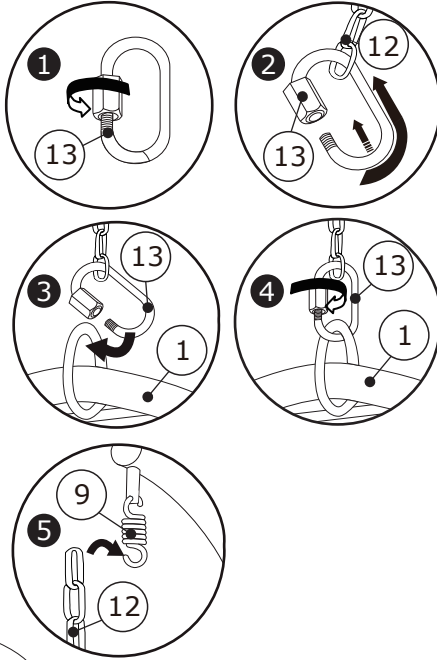
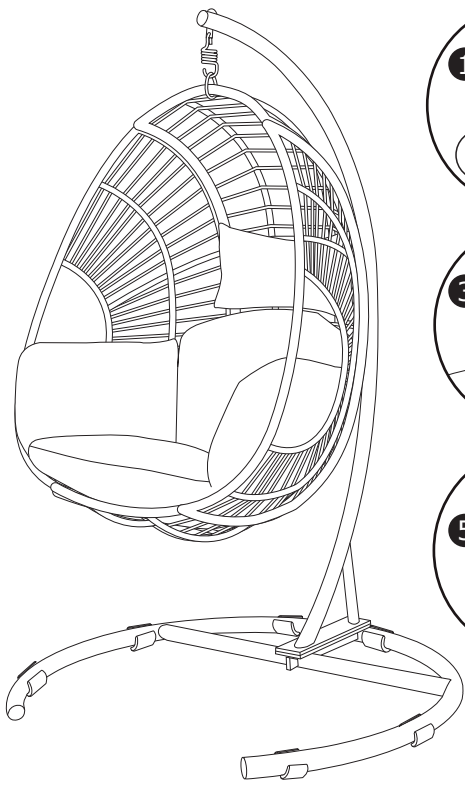



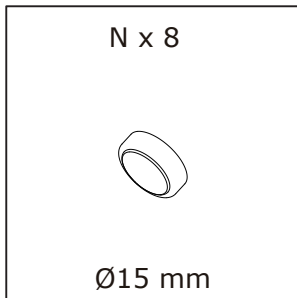
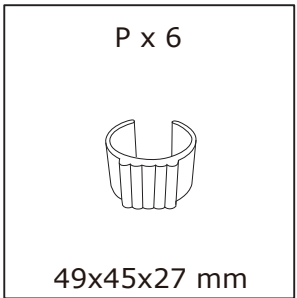
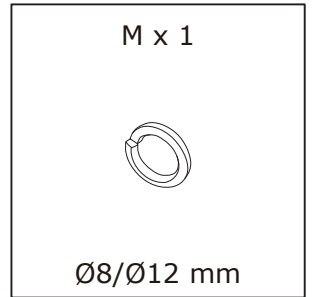
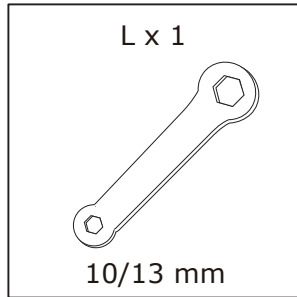
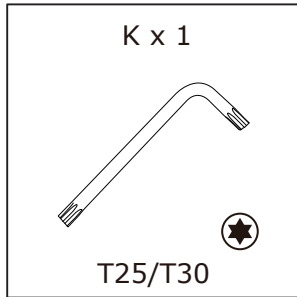
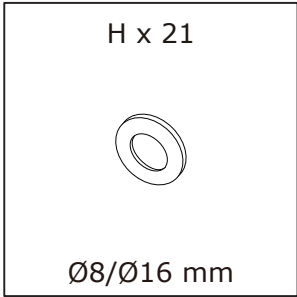
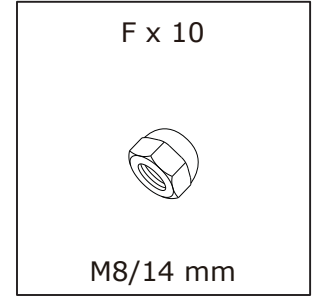
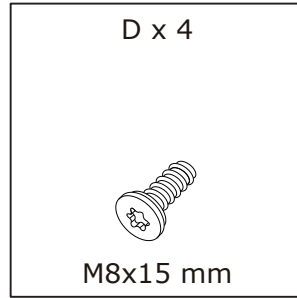
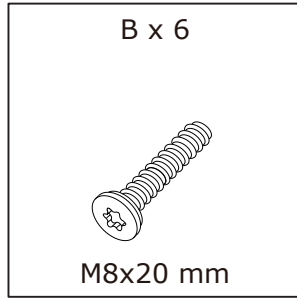
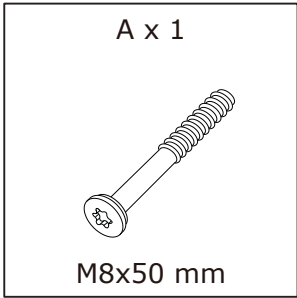

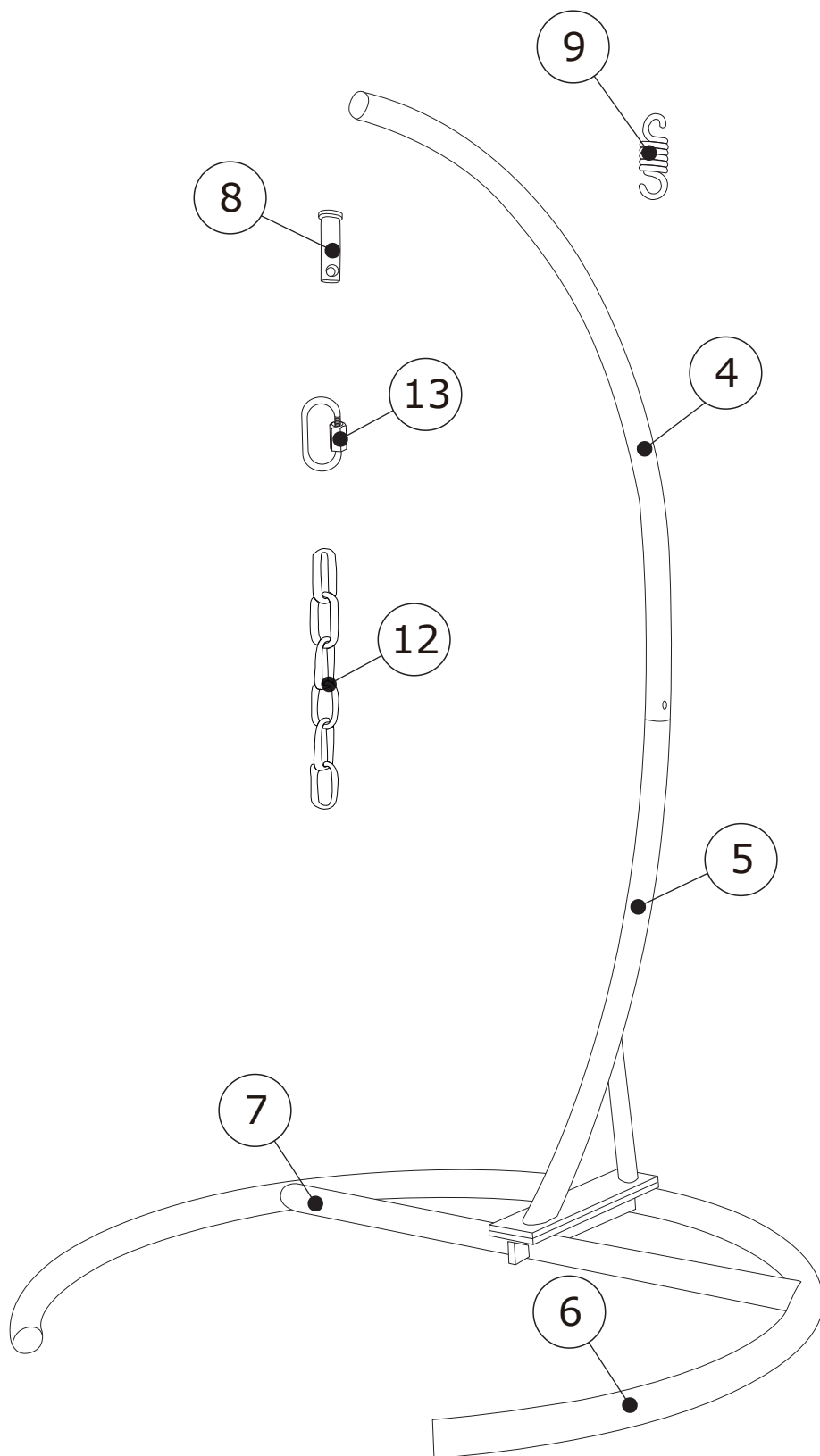









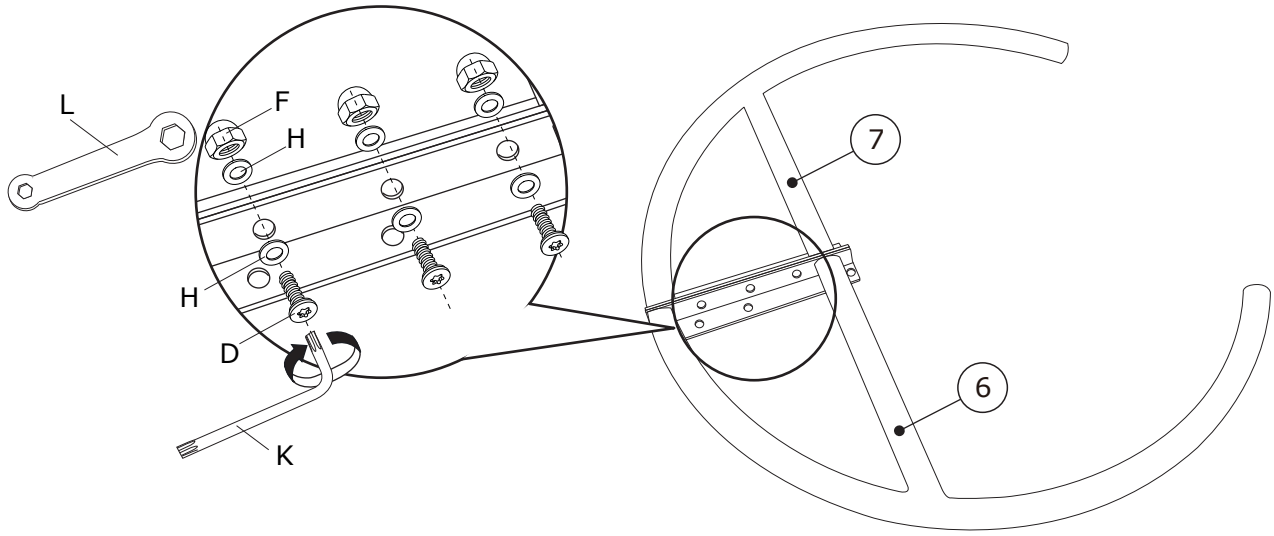
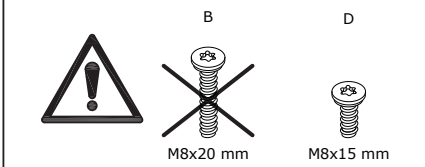

1

D x 3  M8x15 mm	F x 3  M8/14 mm	H x 6  Ø8/Ø16 mm	K x 1  T25/T30	L x 1  10/13 mm	
--	--	---	--	--	--







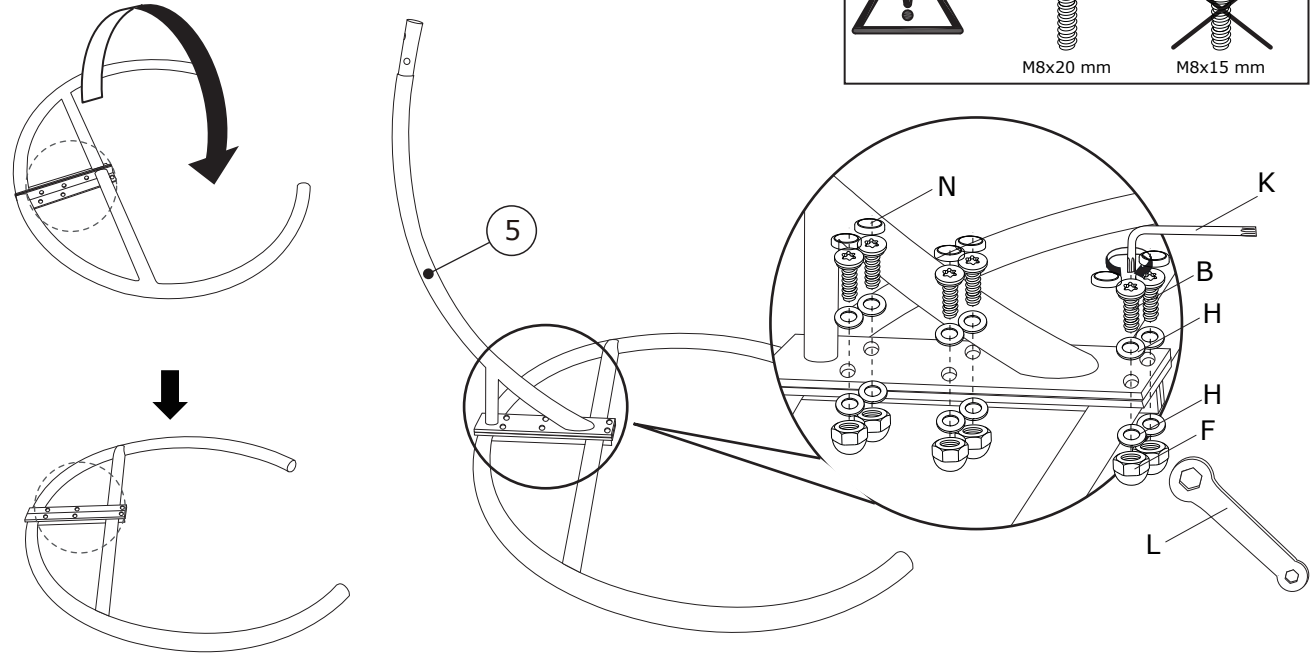
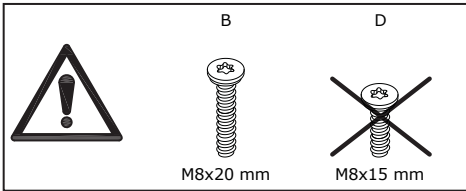

2

B x 6  M8x20 mm	F x 6  M8/14 mm	H x 12  Ø8/Ø16 mm	K x 1  T25/T30	L x 1  10/13 mm	N x 6  Ø15 mm	
--	--	--	--	--	--	--





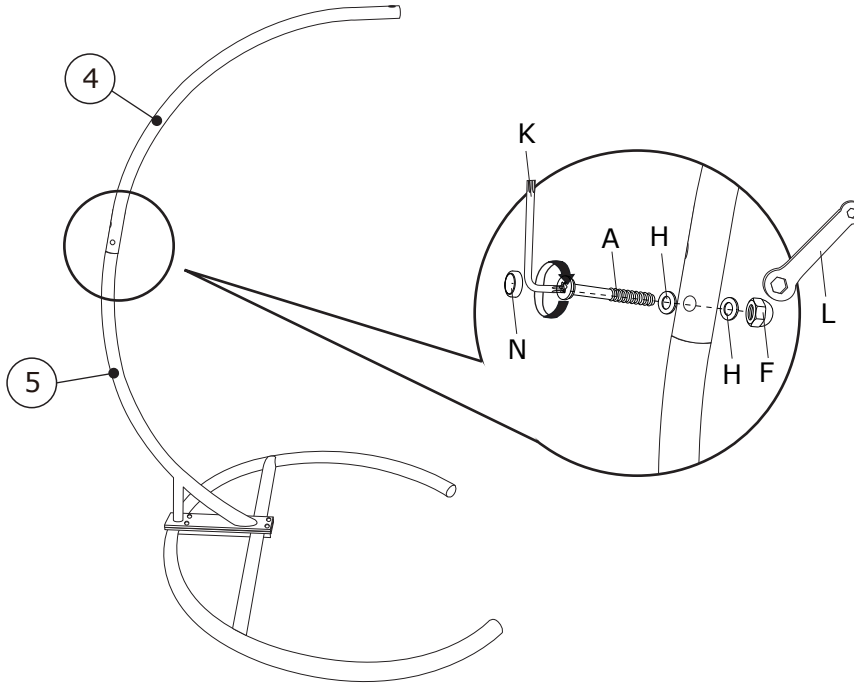

3

A x 1  M8x50 mm	F x 1  M8/14 mm	H x 2  Ø8/Ø16 mm	K x 1  T25/T30	L x 1  10/13 mm	N x 1  Ø15 mm	
--	--	---	---	--	--	--



4

Dx 1  M8x15 mm	M x 1  Ø8/Ø12 mm	K x 1  T25/T30	N x 1  Ø15 mm	H x 1  Ø8/Ø16 mm	
---	---	---	--	---	--

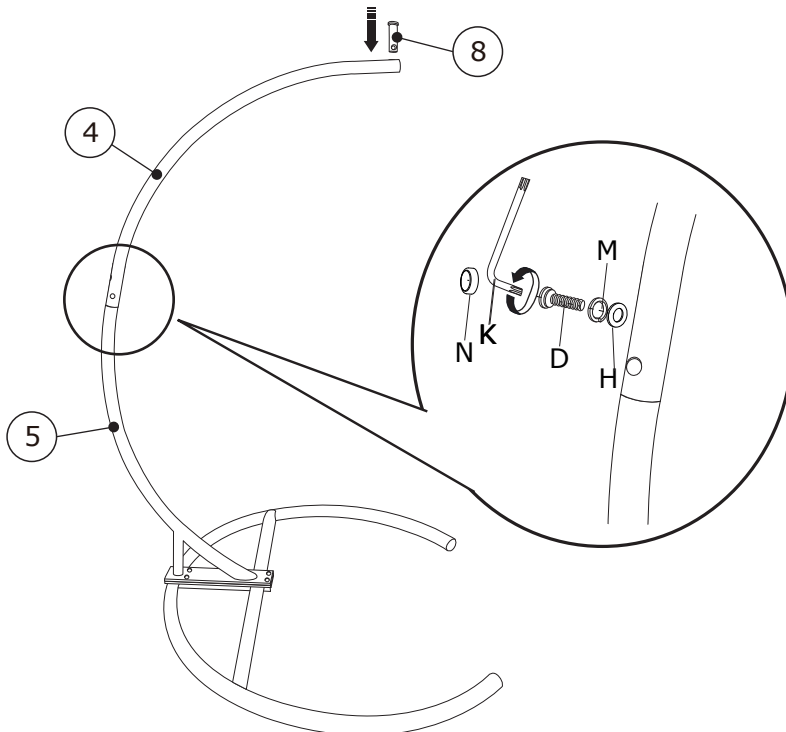

5

