











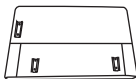

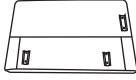
ASSEMBLY INSTRUCTION

PARTS LIST NH-927

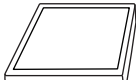
NO	DESCRIPTION	SKETCH	QTY
A	Seat frame		1
B	Seat frame		1
C	Seat frame		1
D	Right Armrest		1
E	Back frame		3
F	Left Armrest		1
G	Seat cushion		3
H	Back cushion		3
I	Pillow		2
J	Foot stool		1
K	Footstool cushion		1
L	Leg		16
M	Long pillow		2

ASSEMBLY INSTRUCTION

All parts and hardware.

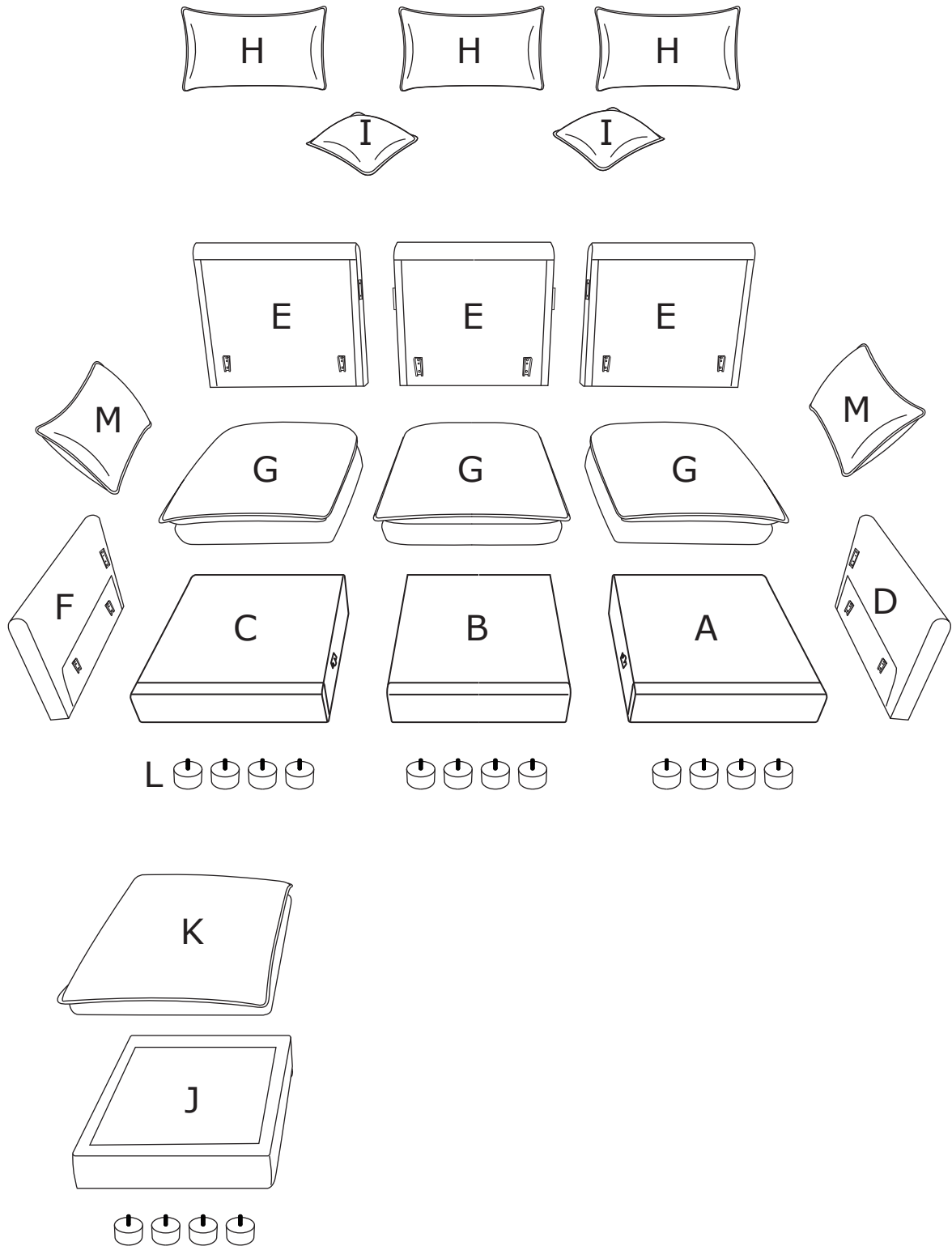

DIAGRAM 1 :Take out Back cushion and Arm Pillow.

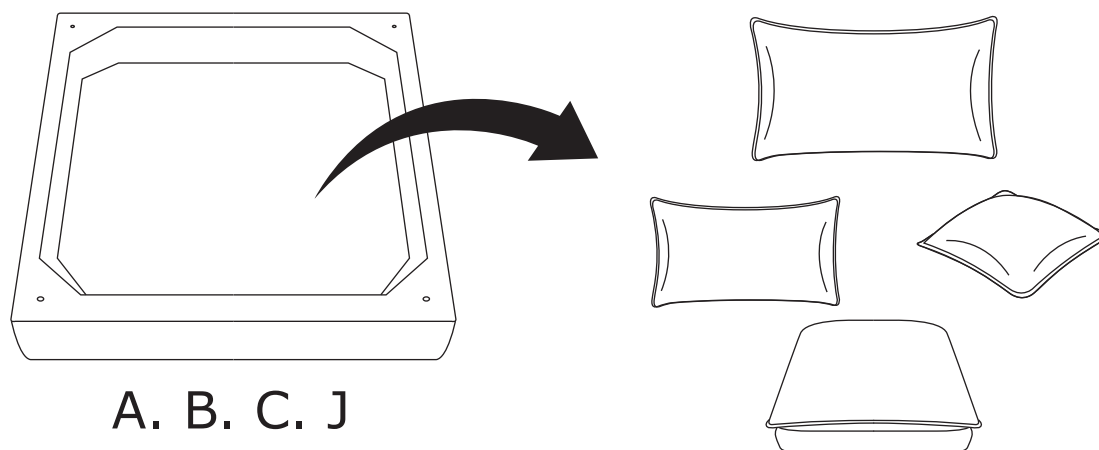

DIAGRAM 2 :Assemble the Leg.

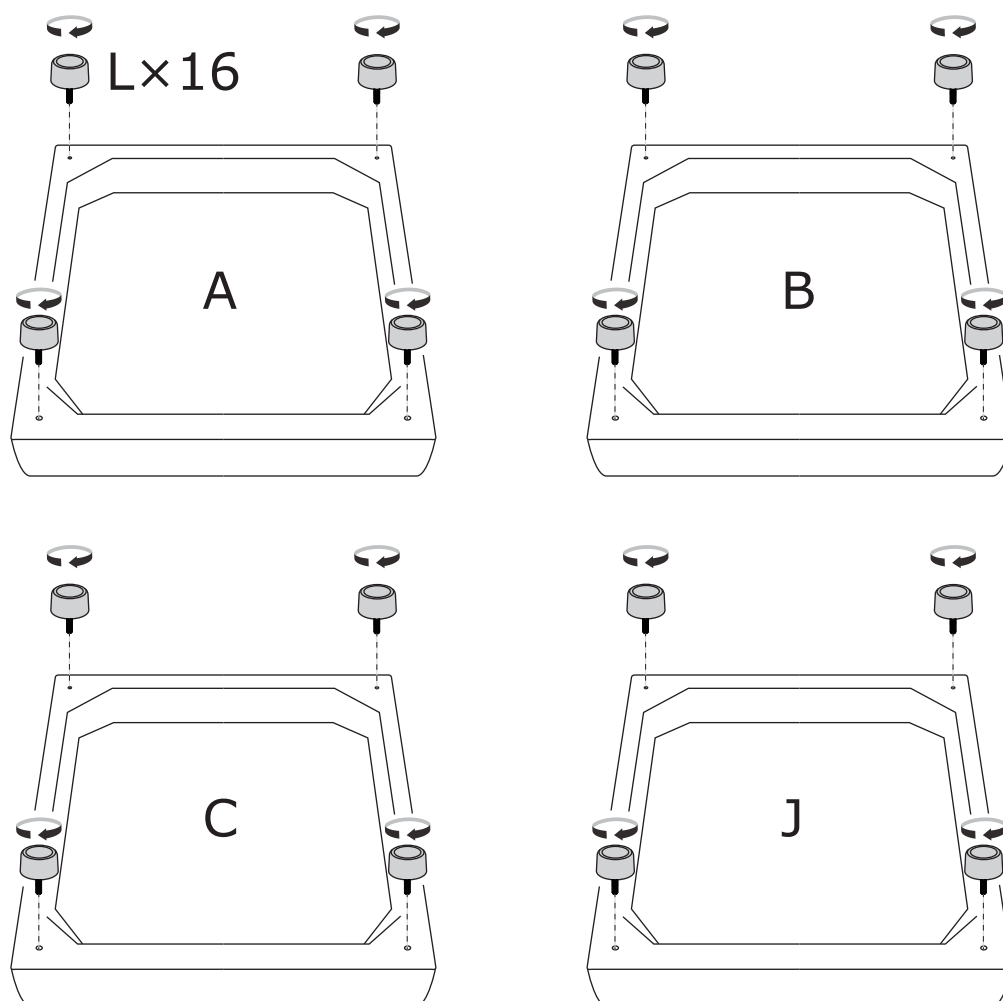

DIAGRAM 3 :Assemble the Seat frame.

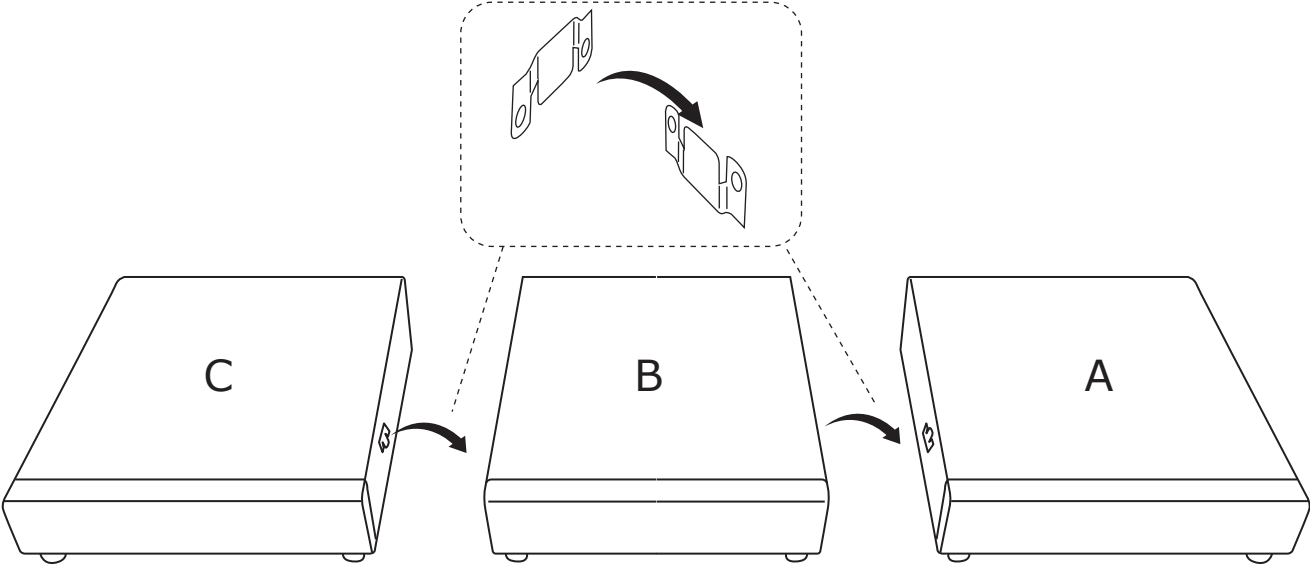

DIAGRAM 4 :Assemble th Armrest (Right).

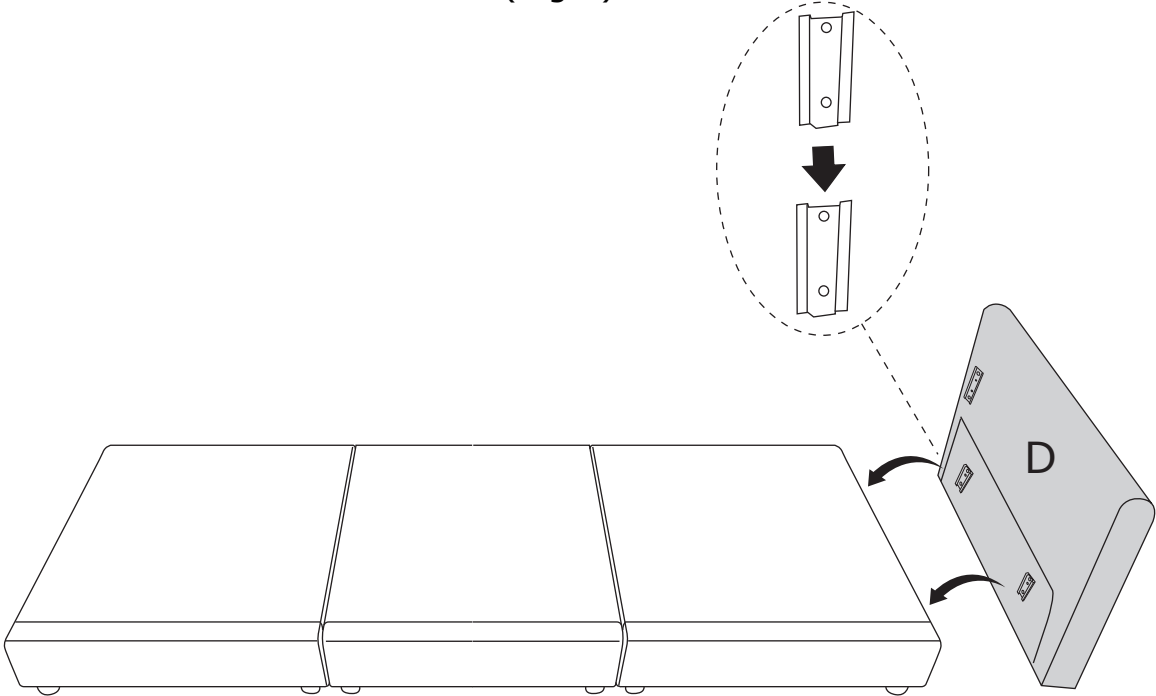

DIAGRAM 5 :Assembled back

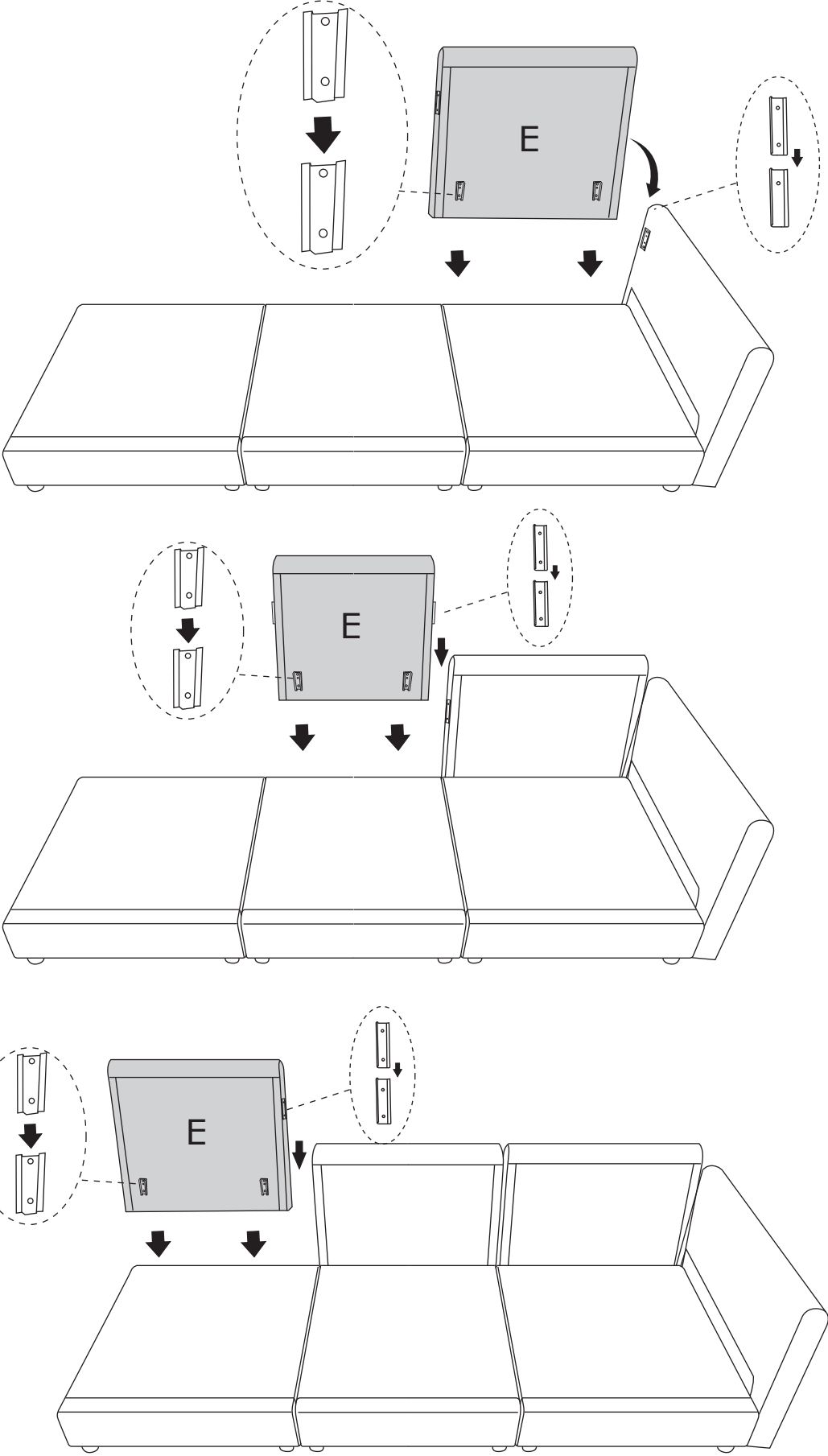

DIAGRAM 6 :Assemble th Armrest (Left).

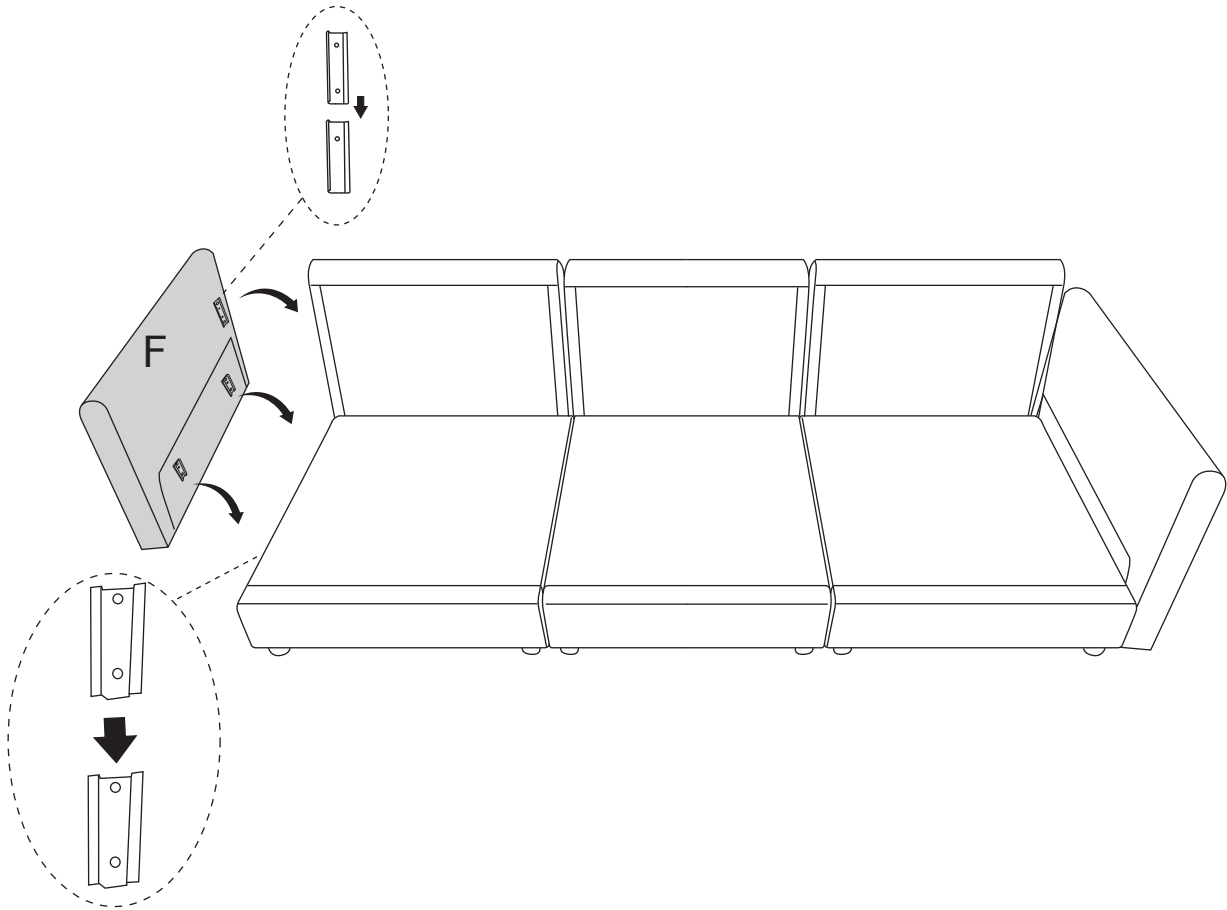

DIAGRAM 7 :The frame of the sofa has been assembled. Next, assemble the cushions and back cushions.

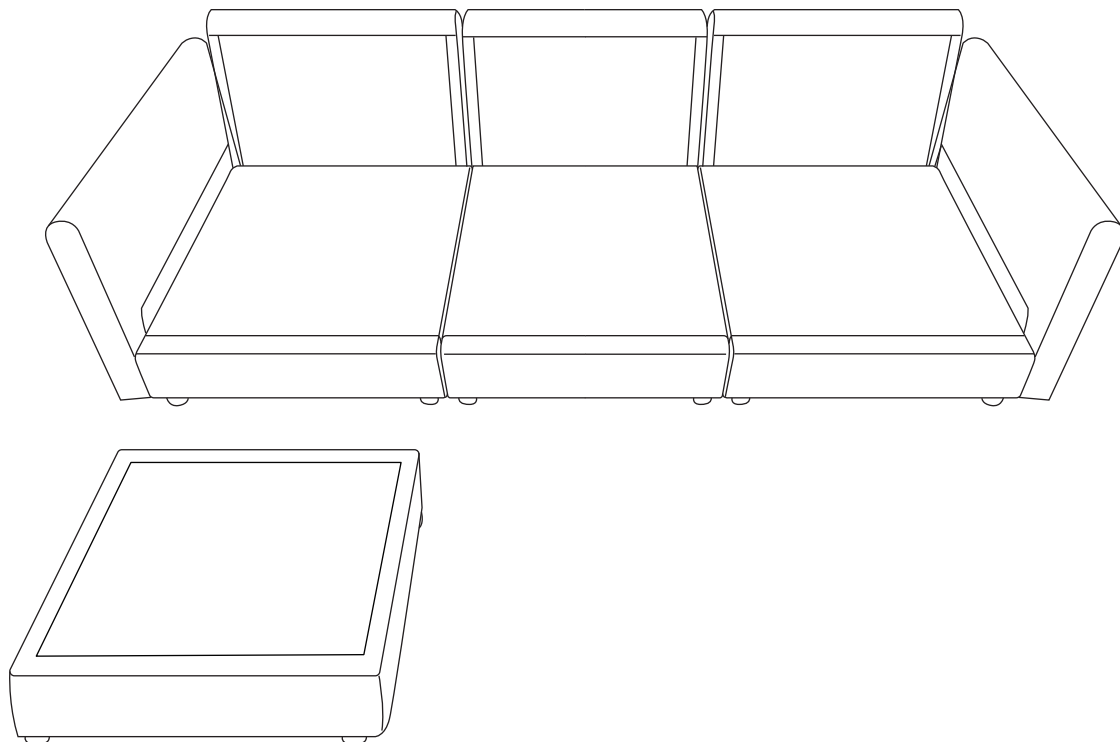

DIAGRAM 8:

The cushions is packaged by vacuum compression. After cutting the package, it rebounds quickly within 4 hours. If the fabric has wrinkles, it will basically disappear after standing for 72 hours

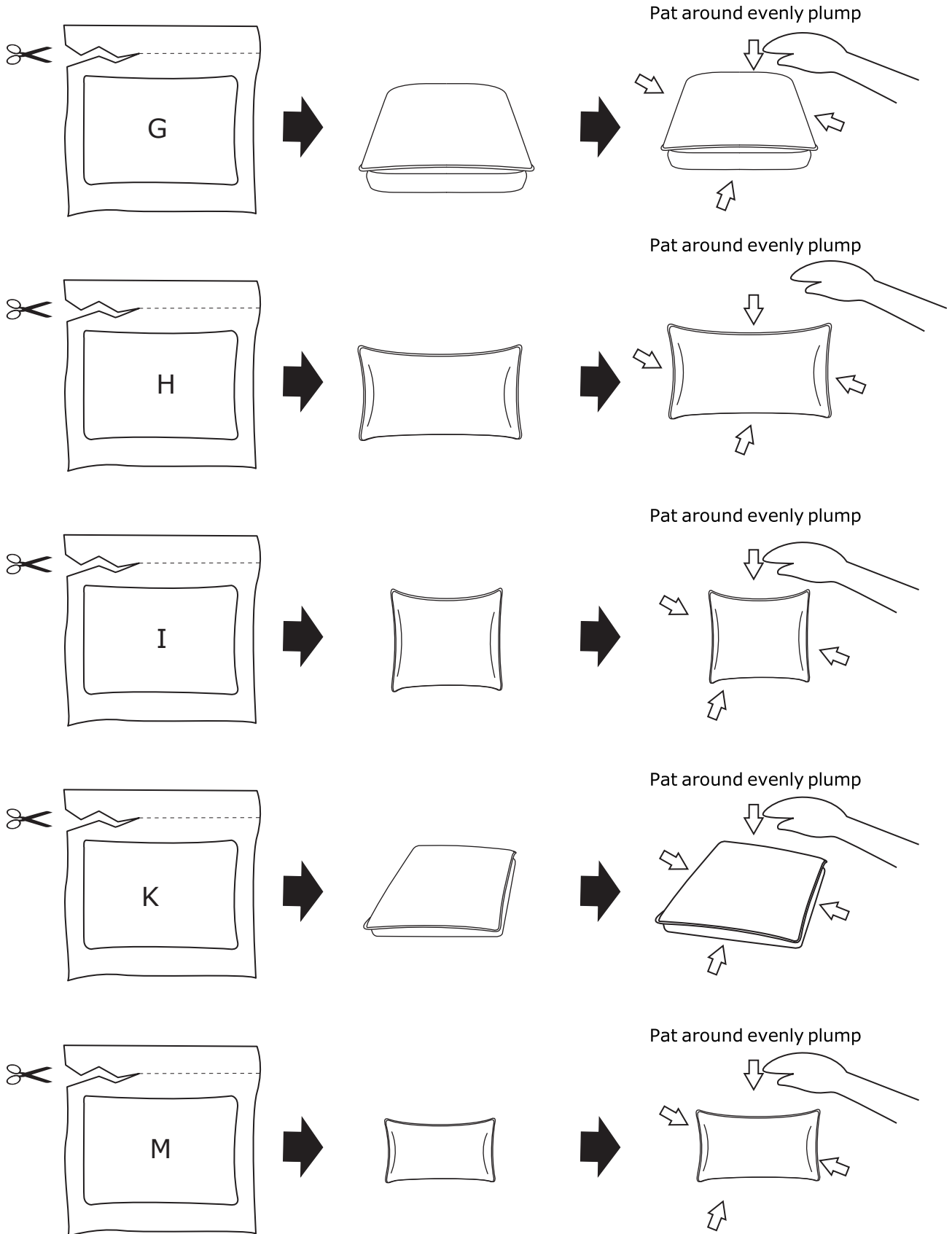

DIAGRAM 9 :Assemble the cushion.

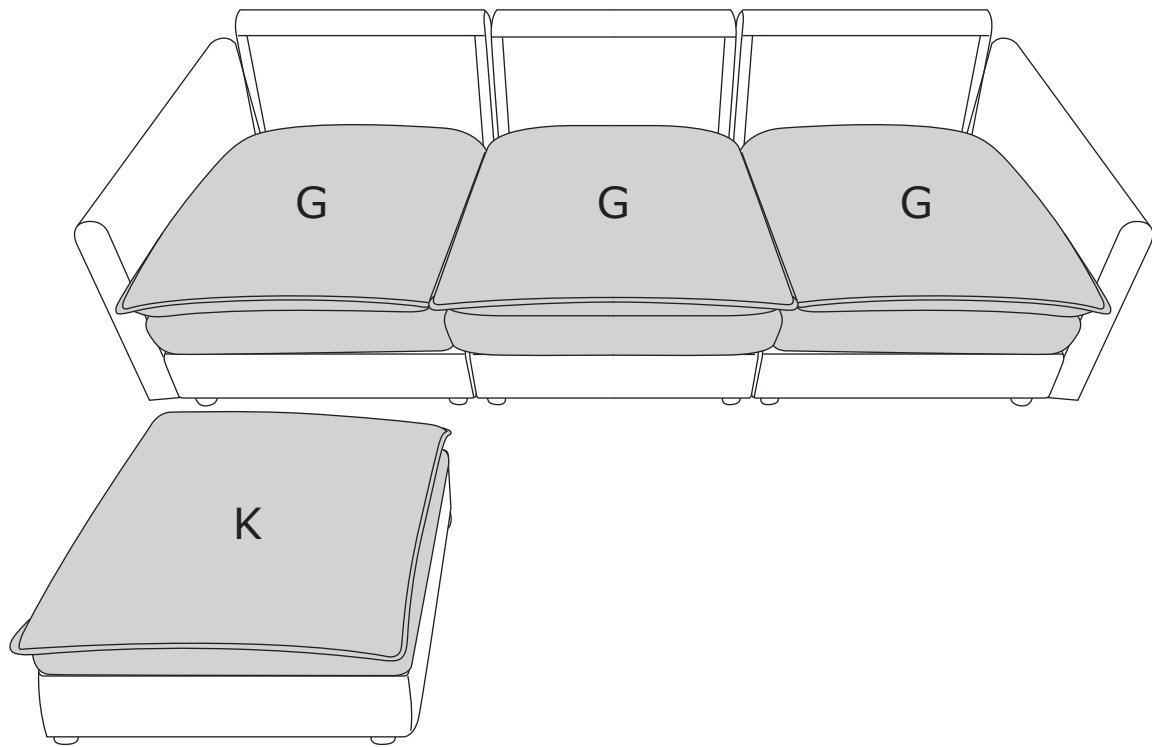

DIAGRAM 10 :Assemble the back cushion.

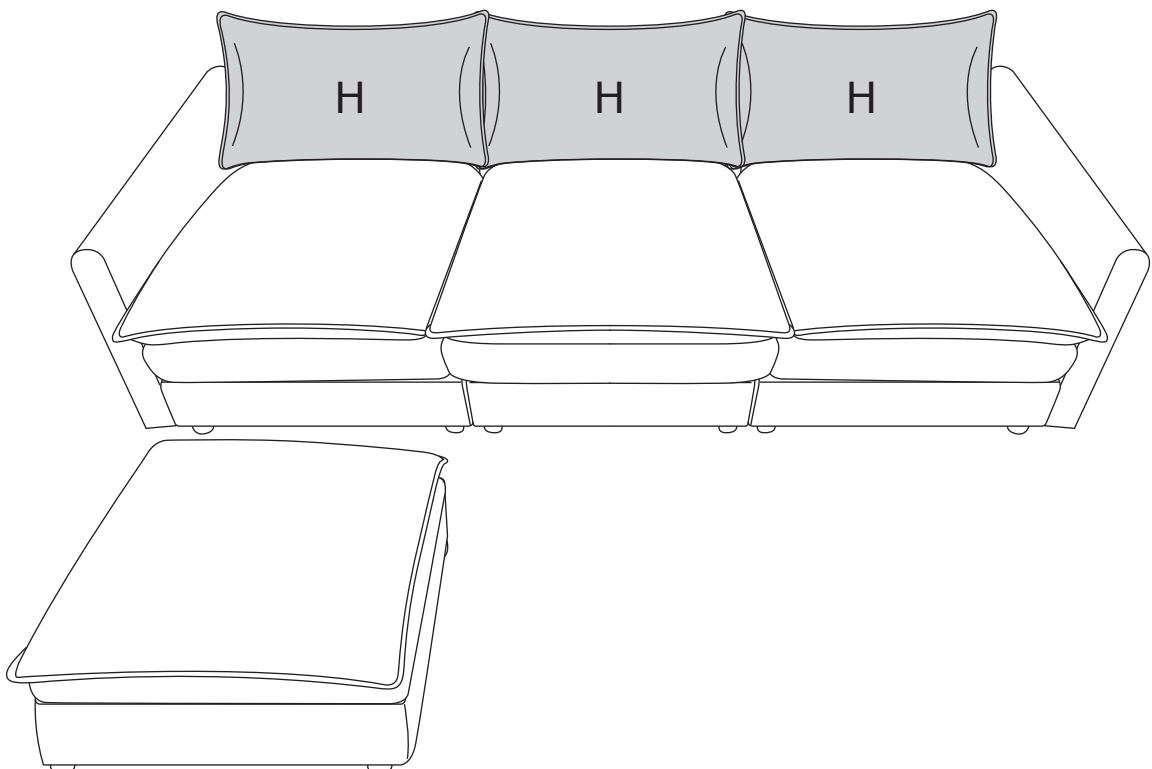

DIAGRAM 11: Assemble Pillow and Long pillow.



DIAGRAM 12: Assembly complete

TIPS:

1. Please do not open the compress packaging until your sofa frame is completely assembled.
2. Compress back cushions and pillows need to be fully fulfilled within 72 hours for your perfect use.
3. Please keep children away from plastic bags or any small pieces of stuff.

