

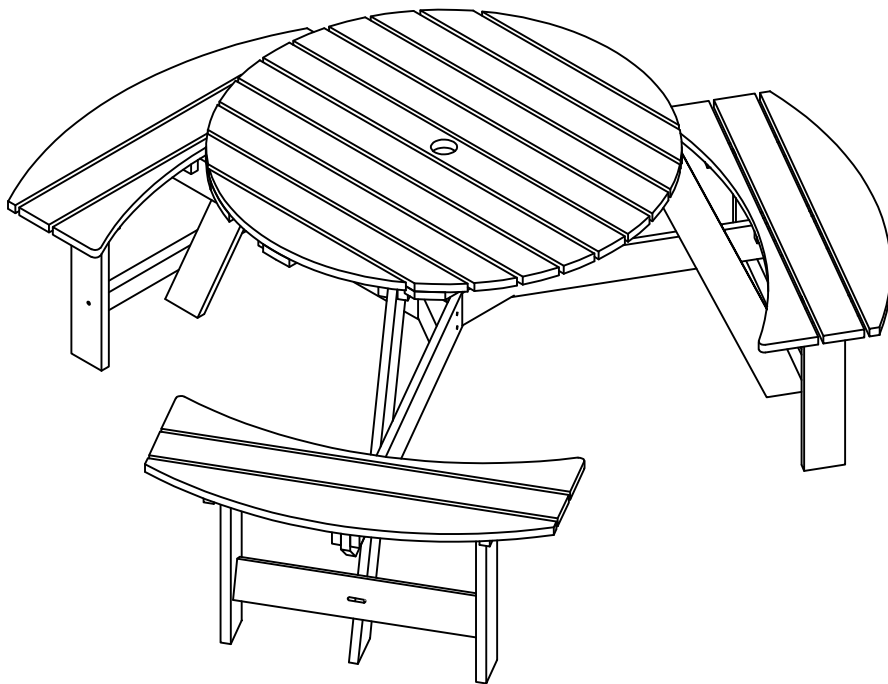









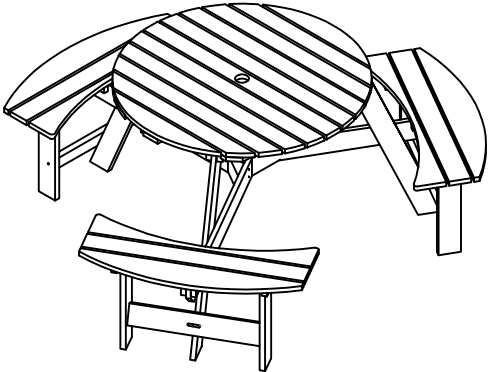



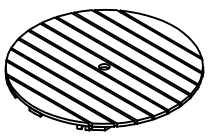



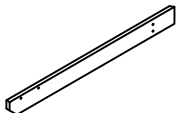

ITEM#DX-003

Outdoor Picnic Table Instrucyion Manual (6-Person)





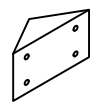

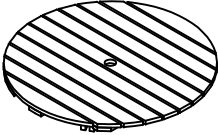
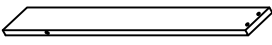

Parts List

Carefully remove the parts from the carton, verify that you have received all components, and place them individually on a soft cloth to prevent scratches or other damage.

			A		12PC
			B		3PC
			C		12PC
			D		3PC
①		1PC	E		15PC
②		3PC	F		15PC
			G		30PC
③		3PC	H		1PC
④		3PC	I		1PC
⑤		6PC	J		1PC
			K		21PC
⑥		3PC	L		27PC
			M		27PC
⑦		3PC	N		6PC



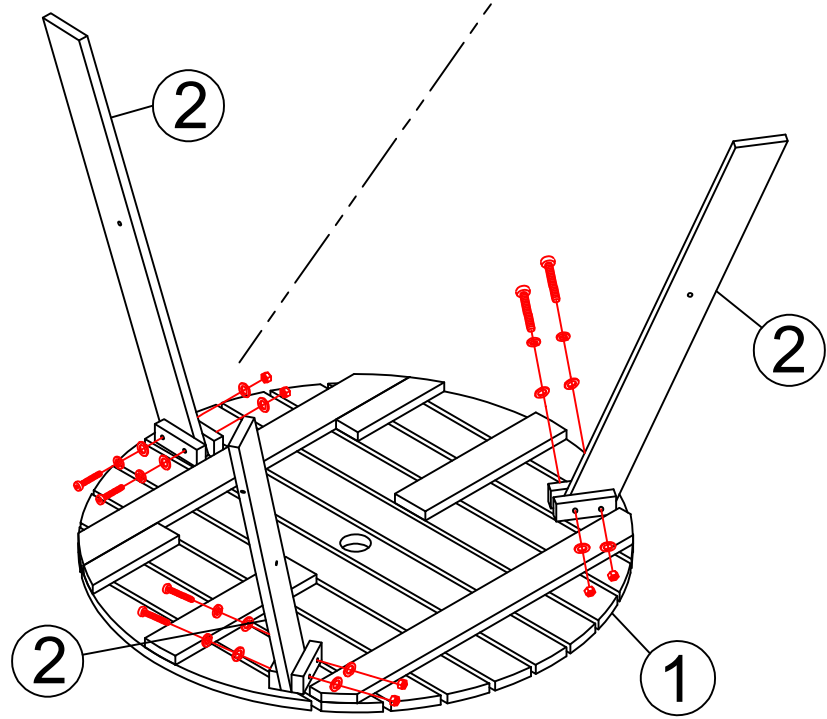
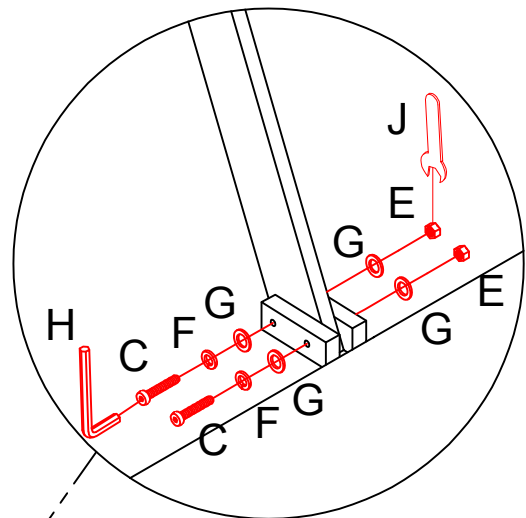

Step 1: Install the table top and legs

①	②	C	E	F	G	H	J
							
1PC	3PC	6PC	6PC	6PC	12PC	1PC	1PC

As shown in the picture, fix the ② table leg with the screw through the slot.

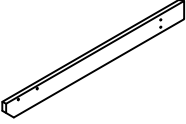

Step 2: Install the tripod





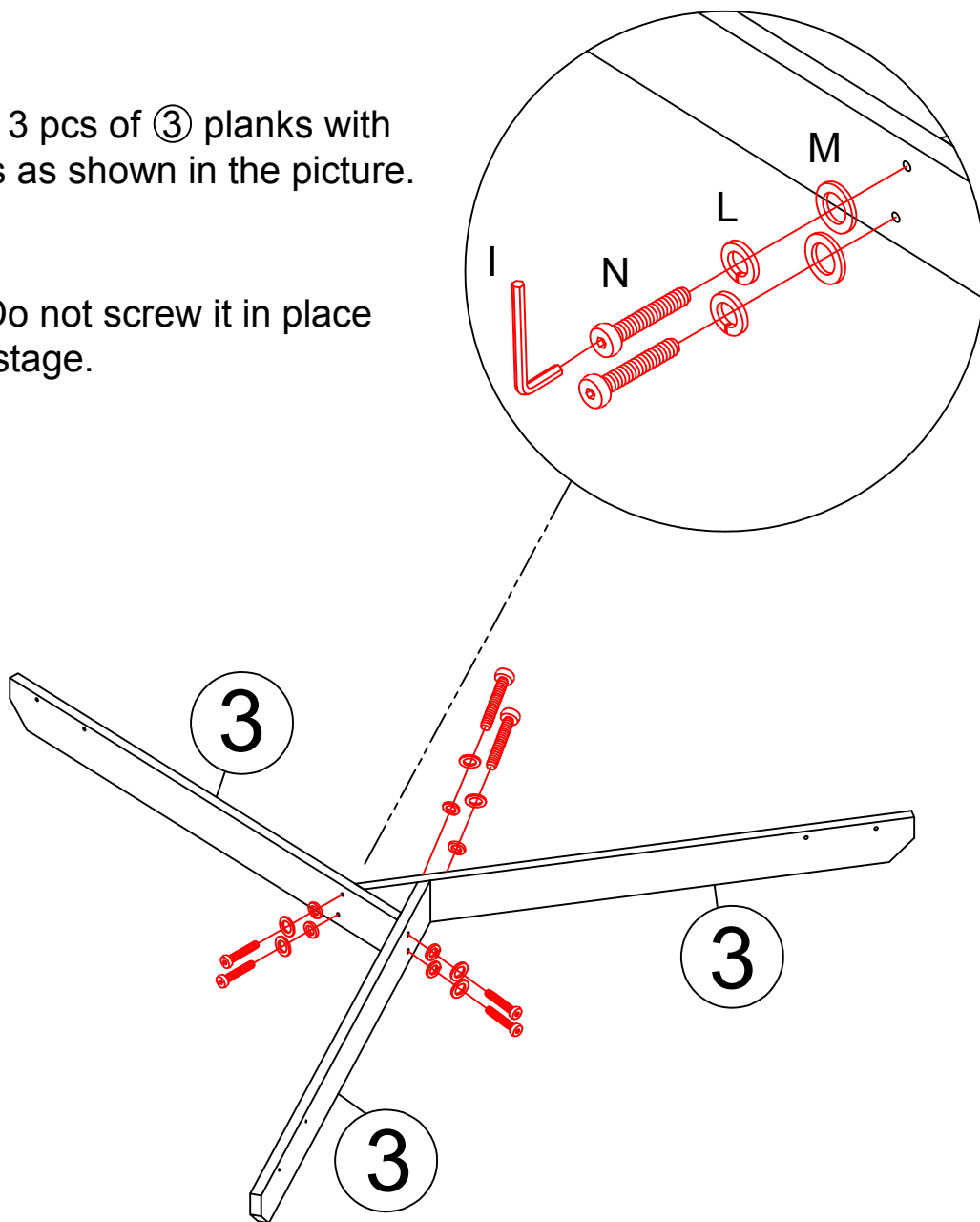

③	N	L	M	I
				
3PC	6PC	6PC	6PC	1PC

Attach 3 pcs of ③ planks with screws as shown in the picture.

Note: Do not screw it in place at this stage.





Step 3: Fix the table legs and tripod with screws as shown in the picture.

B	D	E	F	G	H	J
						
3PC	3PC	3PC	3PC	6PC	1PC	1PC

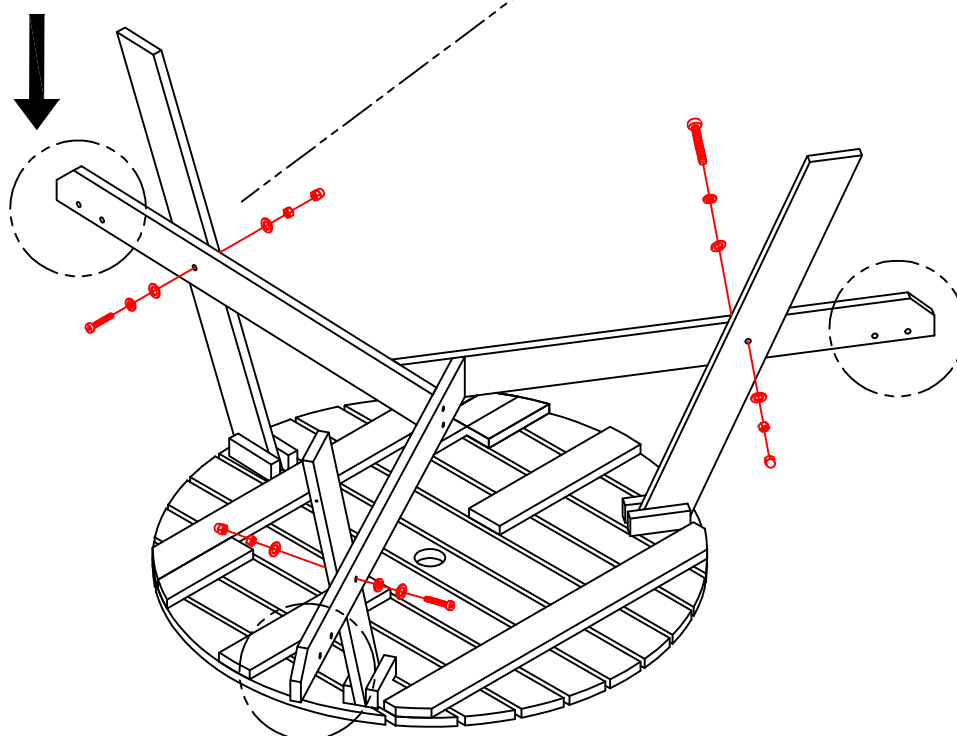
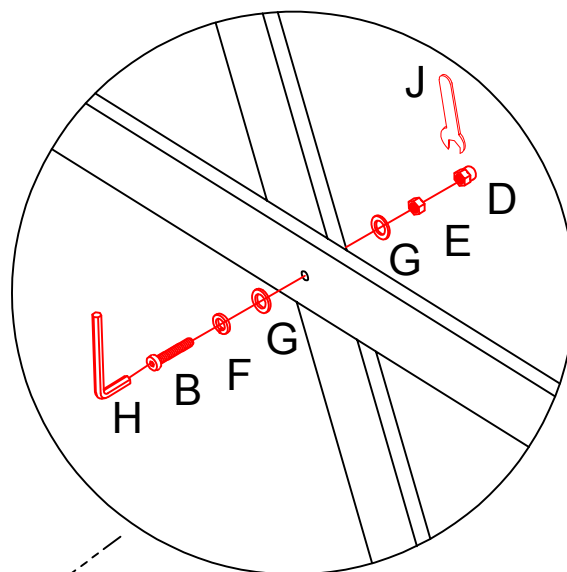
Note: As shown in the picture, the tripod must be placed in the same direction to ensure a smooth assembly. The tripod must be oriented towards the same side as shown in the picture to ensure smooth assembly.



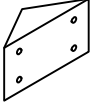



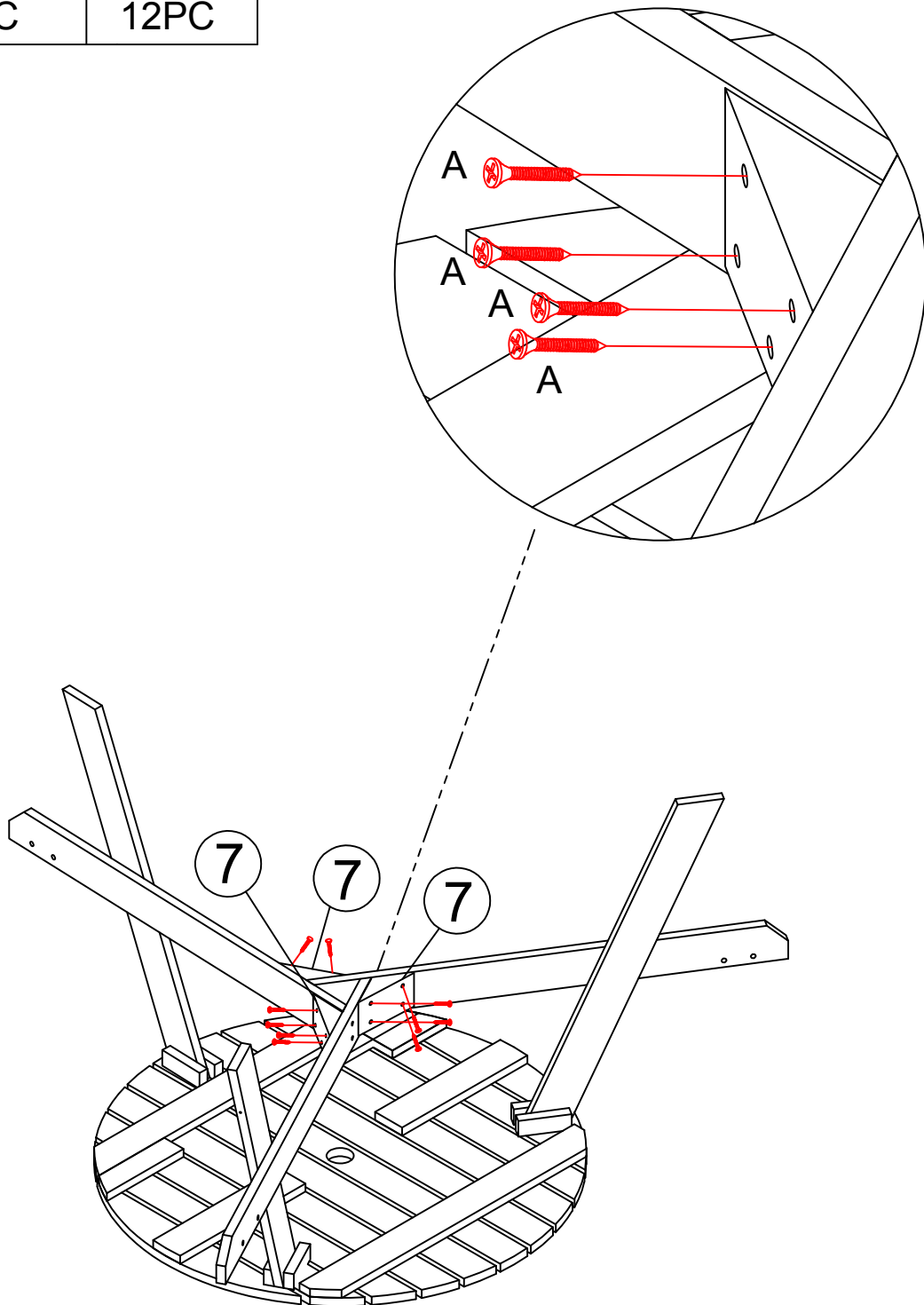

Step 4: Secure the triangular wood block to the tripod with screws as shown.

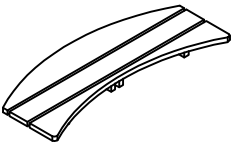
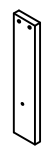
⑦	A
	
3PC	12PC







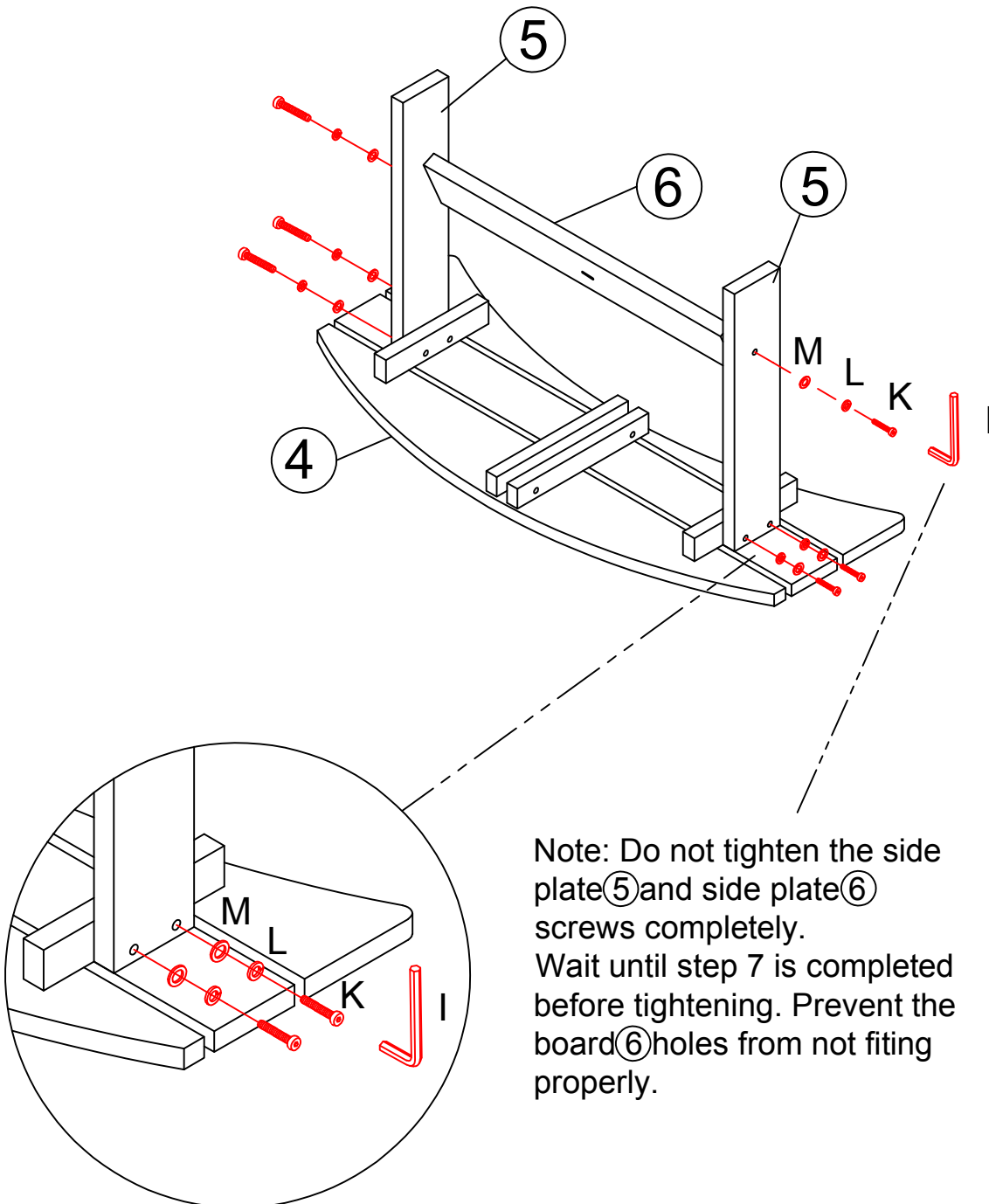

Step 5: Fix the stool with screws.

④	⑤	⑥	K	L	M	I
						
3PC	6PC	3PC	18PC	18PC	18PC	1PC





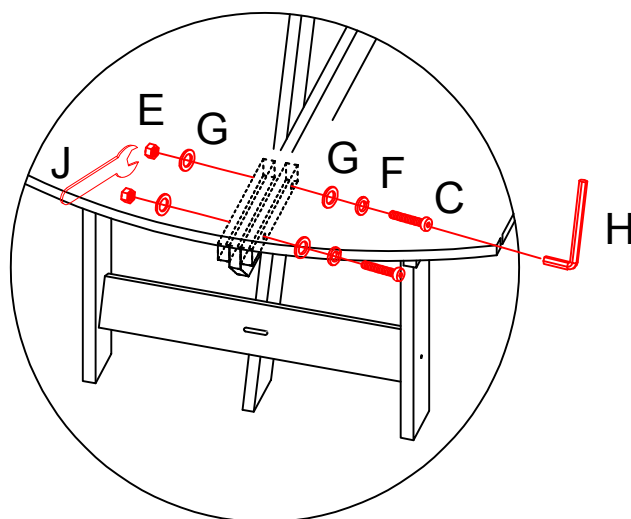
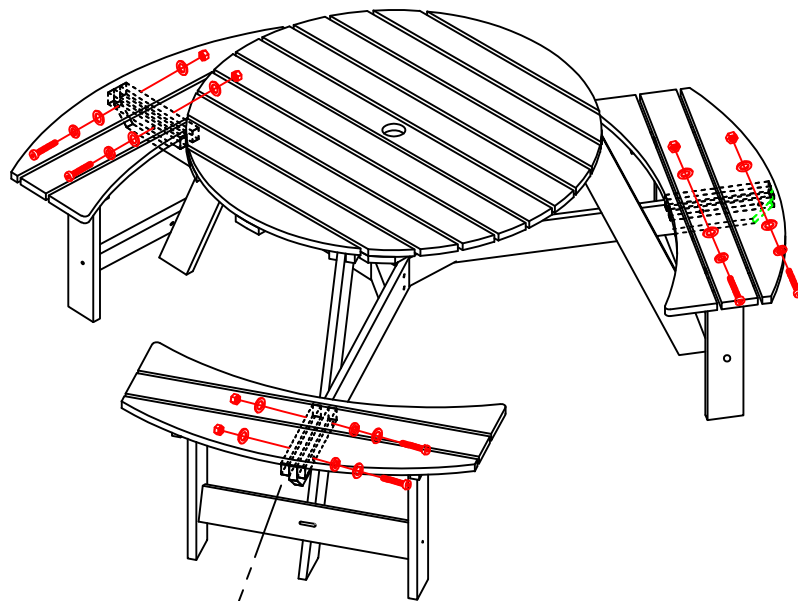

Note: Do not tighten the side plate ⑤ and side plate ⑥ screws completely. Wait until step 7 is completed before tightening. Prevent the board ⑥ holes from not fitting properly.

Step 6: Attach the stool to the tripod.

C	E	F	G	J	H
					
6PC	6PC	6PC	12PC	1PC	1PC



Step 7: Fix table legs and stools with screws.

K	L	M	I
			
3PC	3PC	3PC	1PC

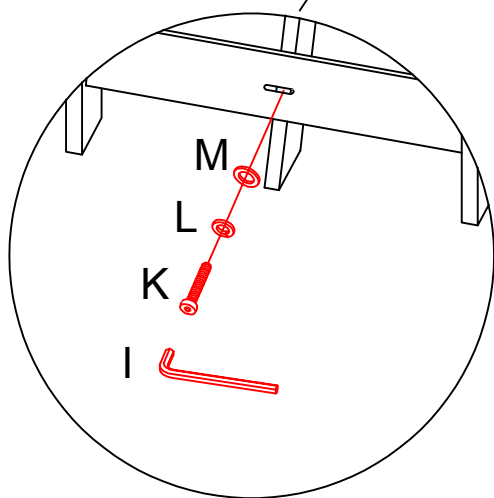
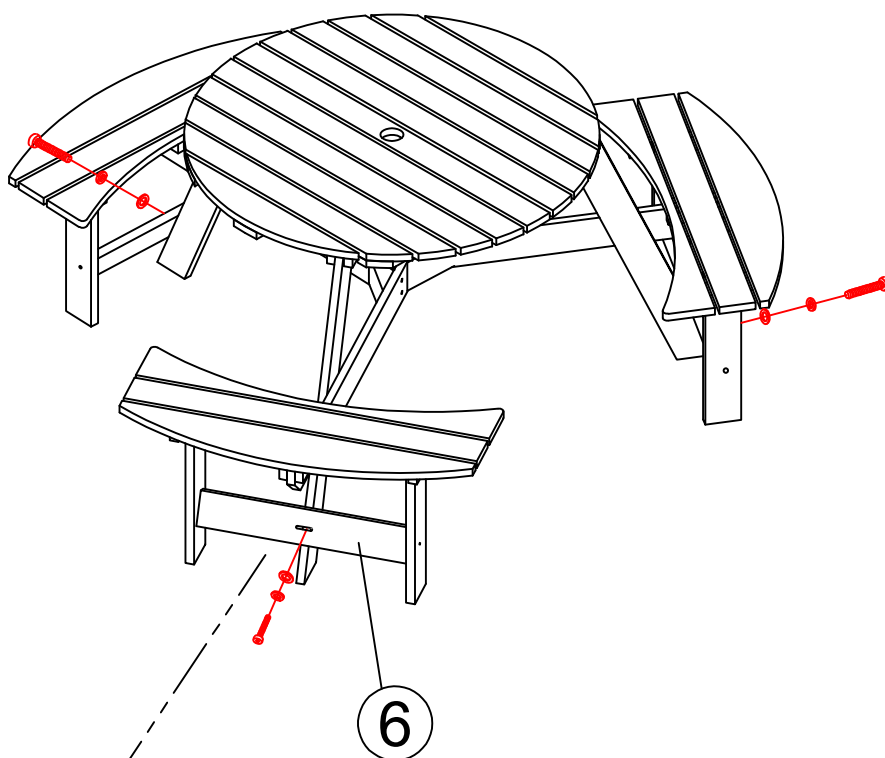

Note: There is no need to adjust the direction of the wooden board⑥, and it can be installed normally on both sides.