

Assembly Instructions

A x 1

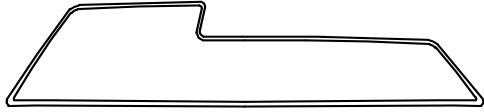

B x 1

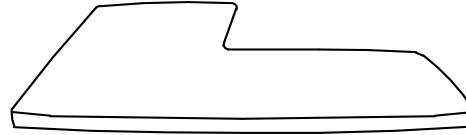

C x 1



D x 1

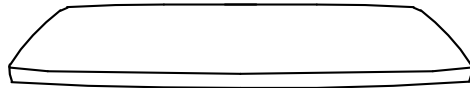

E x 4

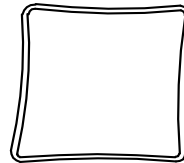

F x 4

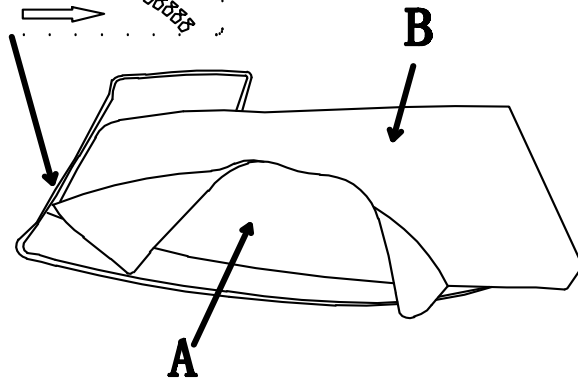
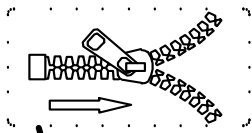
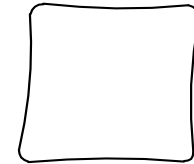

1

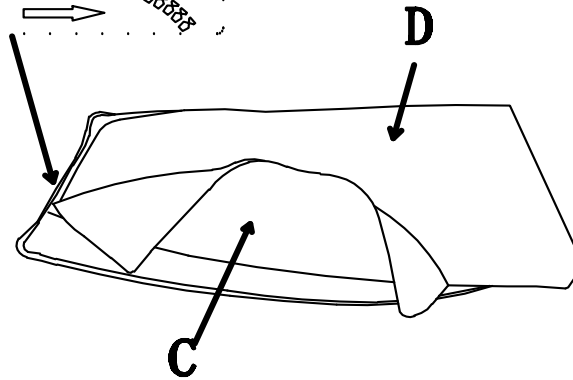
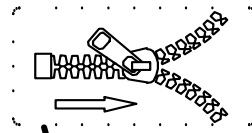

2

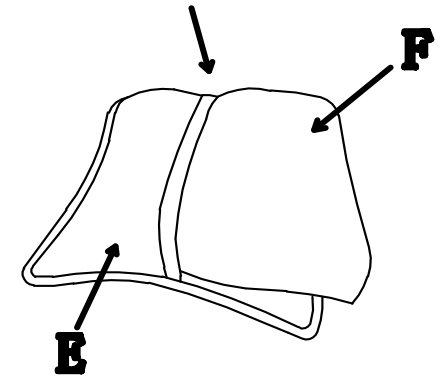
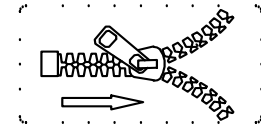

3

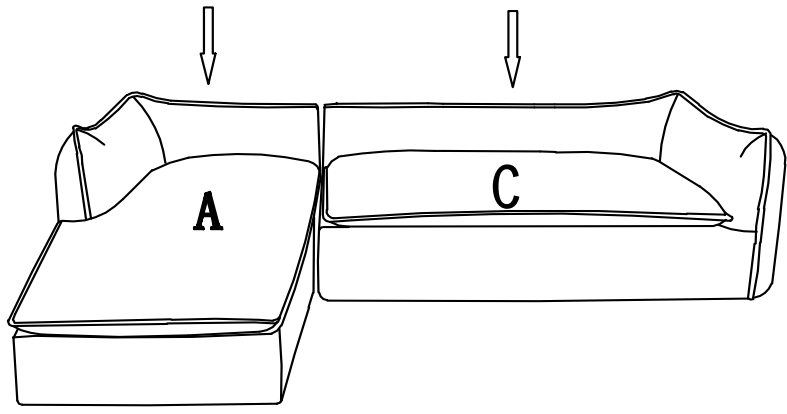

4

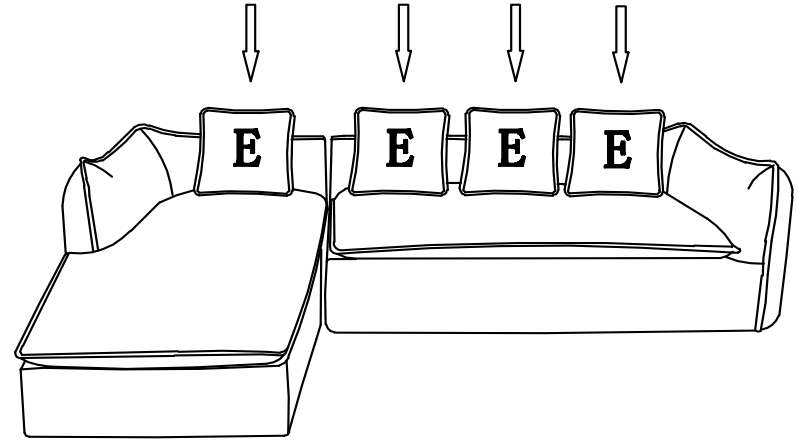

5

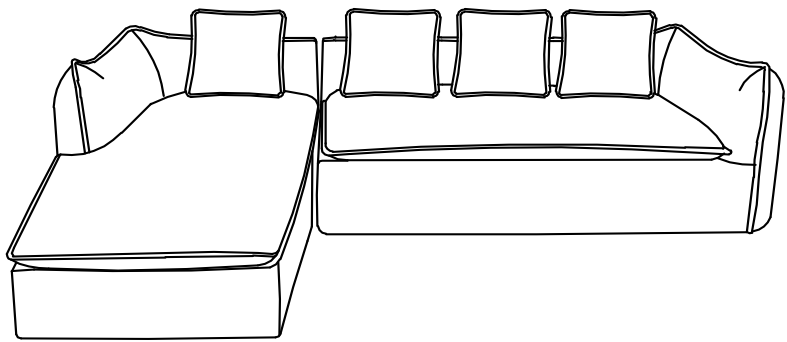

6