

# BAMBOO TOWEL RACK

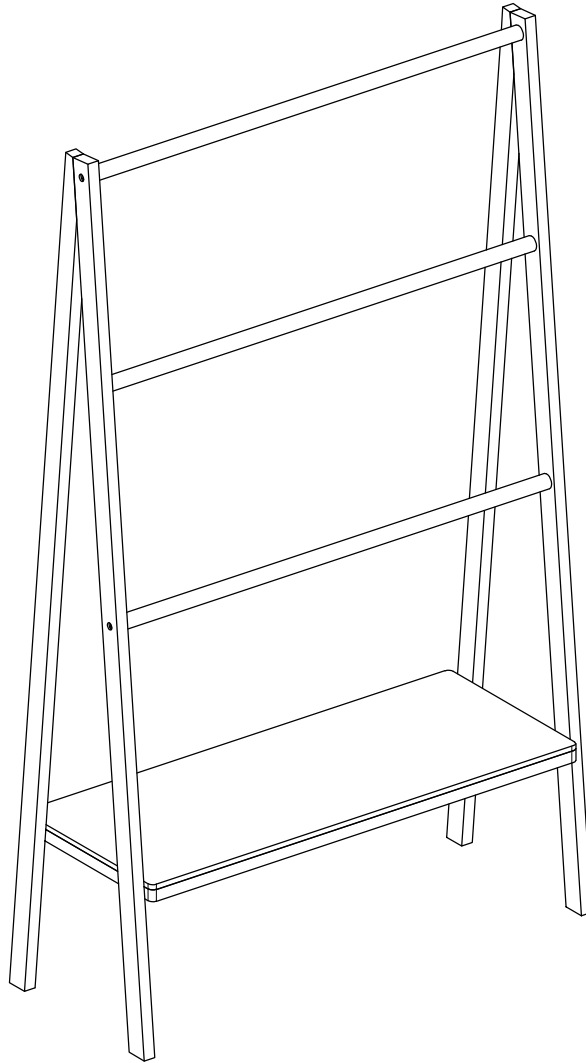

W2207P147173

## Getting started

Thank you for purchasing this product. Read the instructions and warnings carefully before use, to ensure safe and satisfactory operation of this product.



## WARNING

- Do not let any sharp objects touch or rub the surface of the product.
- When assembling, do not let children play around the working area.
- Please confirm all parts are correct before starting the assembly process.
- Do not tighten all bolts and screws completely until the entire unit has been assembled and set up.
- **DO NOT USE POWER TOOLS.**
- Power tools can over tighten screws and strip threads.
- For each screw:
  1. Tighten each screw until you meet resistance.
  2. Tighten one additional full rotation. **DO NOT OVER TIGHTEN.**

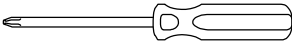
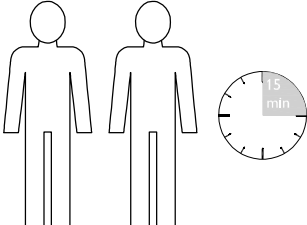

<p>Tools required</p>  <p>(Not Supplied)</p>	<p>two persons , 15 minutes</p> 
---	---

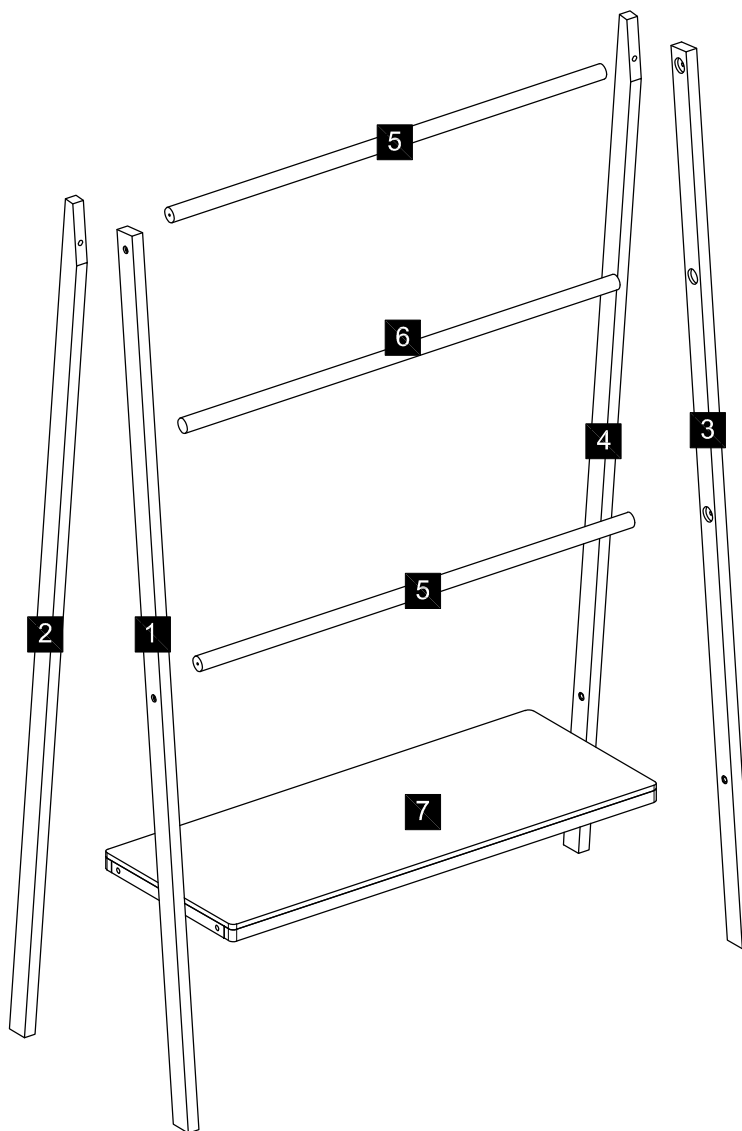

# Fittings and parts checklist

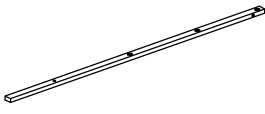
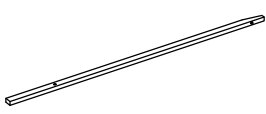
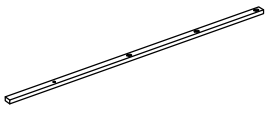
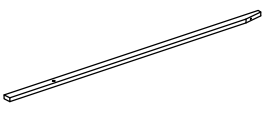
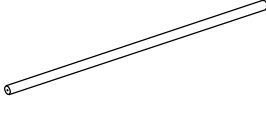
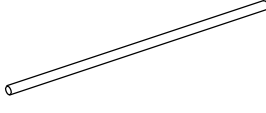

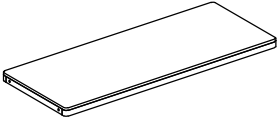
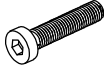
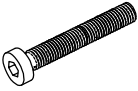
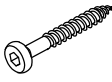
No.	Picture	Name	Qty	No.	Picture	Name	Qty
1		Front left side rail	1	2		Back left side rail	1
3		Front right side rail	1	4		Back right side rail	1
5		Rail	2	6		Rail	1

No.	Picture	Name	Qty	No.	Picture	Name	Qty
7		Shelf	1	A		Bolt	4
B		Bolt	2	C		Screw	4
D		Felt pad	4	E		Allen key M4	1

# Product assembly

## Step 1

Parts, fittings and tools

1 2 3 4 B E

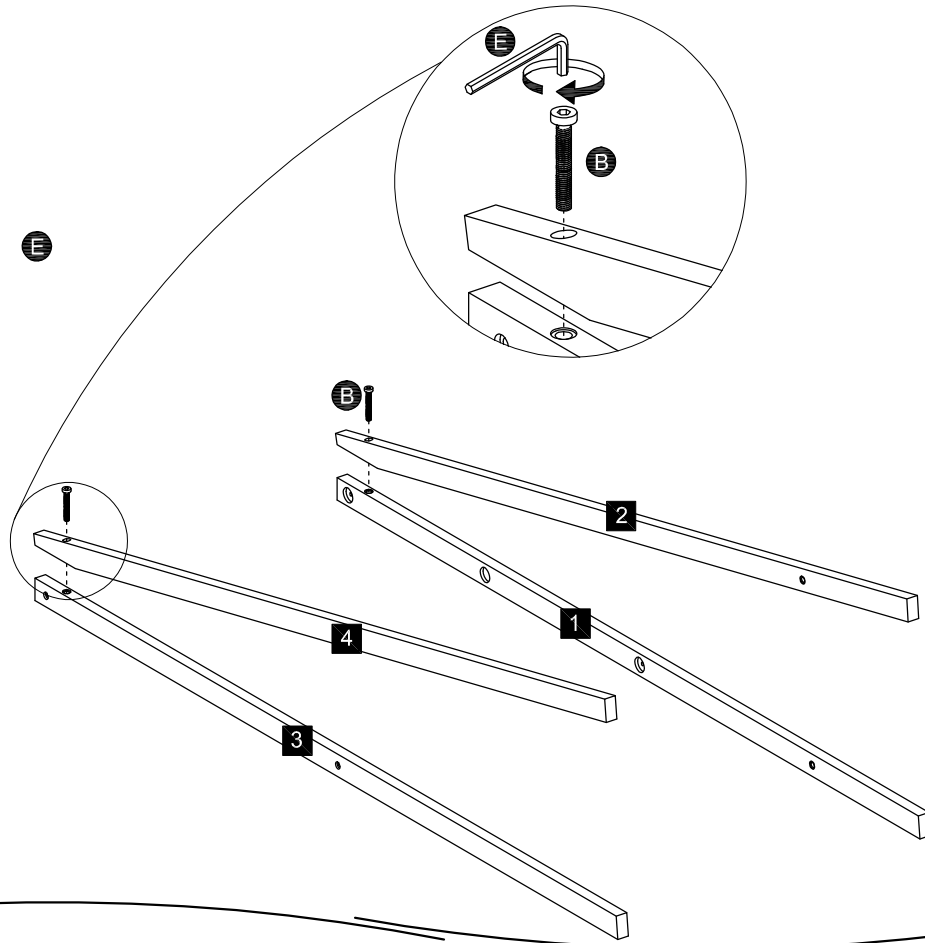

## Step 2

Parts, fittings and tools

3 4 5 6 7  
A C E

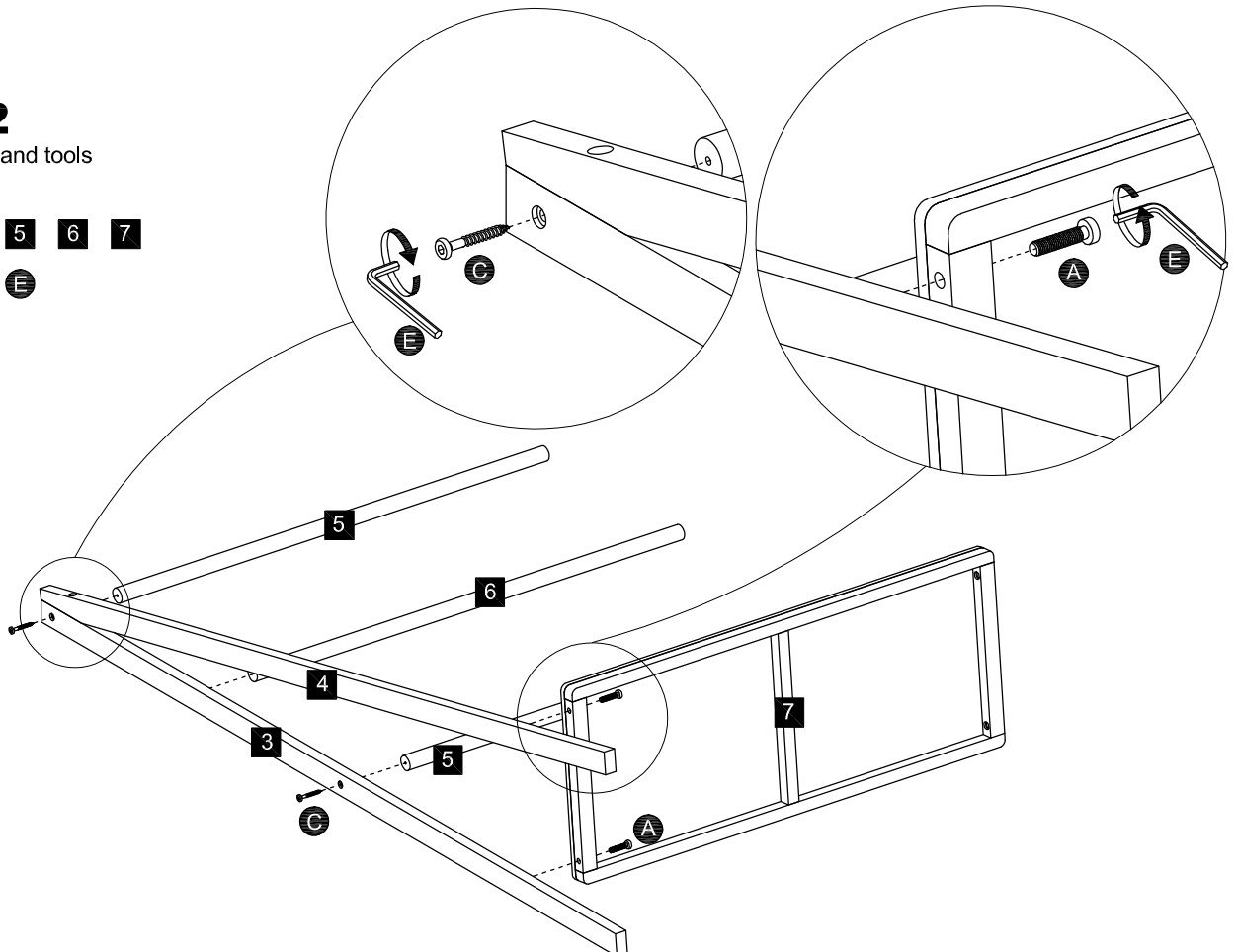

## Step 3

Parts, fittings and tools

1 2 5 6 7

A C E

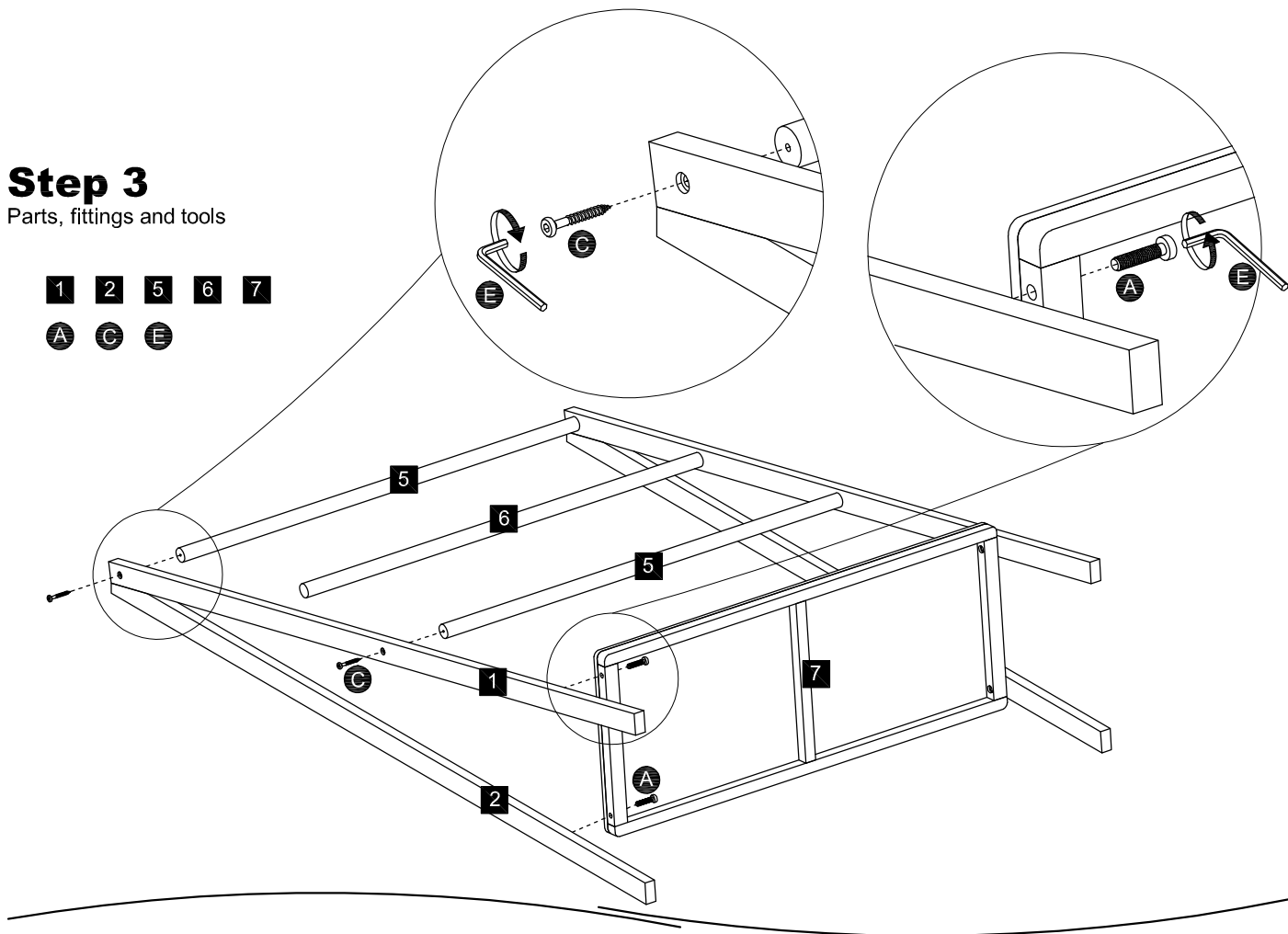

## Step 4

Parts, fittings and tools

1 2 3 4 D

