

# 40"x70" Rect. Dining Table







## ASSEMBLY INSTRUCTIONS

OE-390-1A

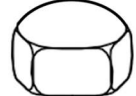

### BEFORE ASSEMBLY:

- Please read these instructions carefully before starting assembly. We suggest you carry out the assembly on a soft surface like a carpet, so as to avoid scratching the paint. Keep children away during assembly. This item contains small parts which can be swallowed by children.
- This product was made for the explicit purpose of providing outdoor function and is not to be used as a toy. This product is for residential use only. This product is NOT intended for commercial use; unintended use will void the warranty.
- This product is not intended for use during inclement or severe weather, that includes but is not limited to rain, hail, sleet, snow, wind, freezing conditions and extreme heat.
- Please note because of the nature of cast metal, you may find roughness on the surface which enhances the beauty of the product and is not a defect.
- Aluminum is soft metal, please do not use power tools, and over tighten may strip threads or break the parts.
- When not in use, store and/or cover the product in a cool dry location. Do not locate the product near any sort of high heat. Do not use the product as a support.
- Children under the age of 10, who are near the product, should be supervised by a competent adult at all times.
- Do not discard any of packaging until you finish the assembly. Keep the assembly instructions for future reference or warranty.

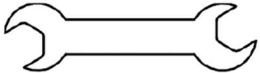
A × 4  Table Leg	B × 4  Table top	C × 16  Bolt(M6×20)
D × 16  Washer(M6)	E × 16  Bolt cap(M6)	F × 16  Lock Washer
G × 1  Wrench		

# 1

**Step 1:** Place all the parts on a clean and soft surface, identify all the parts and hardware kits against parts list. Turn over the Table top(B) onto a flat surface; Assemble table Leg(A) and Table top(B) with parts(D,F,C,E) in the order displayed in Fig. Then assembly the other side of Leg(A). Tighten all the Bolts(C) loosely at this stage. Repeat this step with other three leg(A).

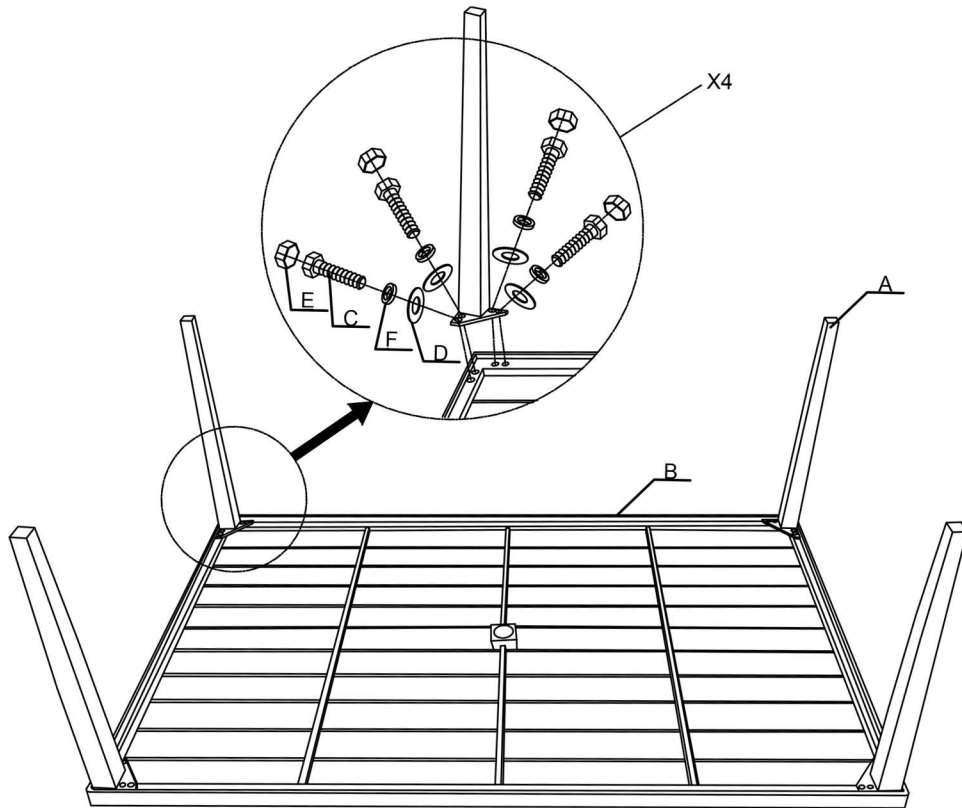

# 2

**Step 2:** Turn over the table. Your table is now ready for use. If find the table is not stable, double check your assembly procedure or loosen some bolts and tighten them again.



Tip: Tighten all the bolts with Wrench(G)

# Dining Chair (K/D)





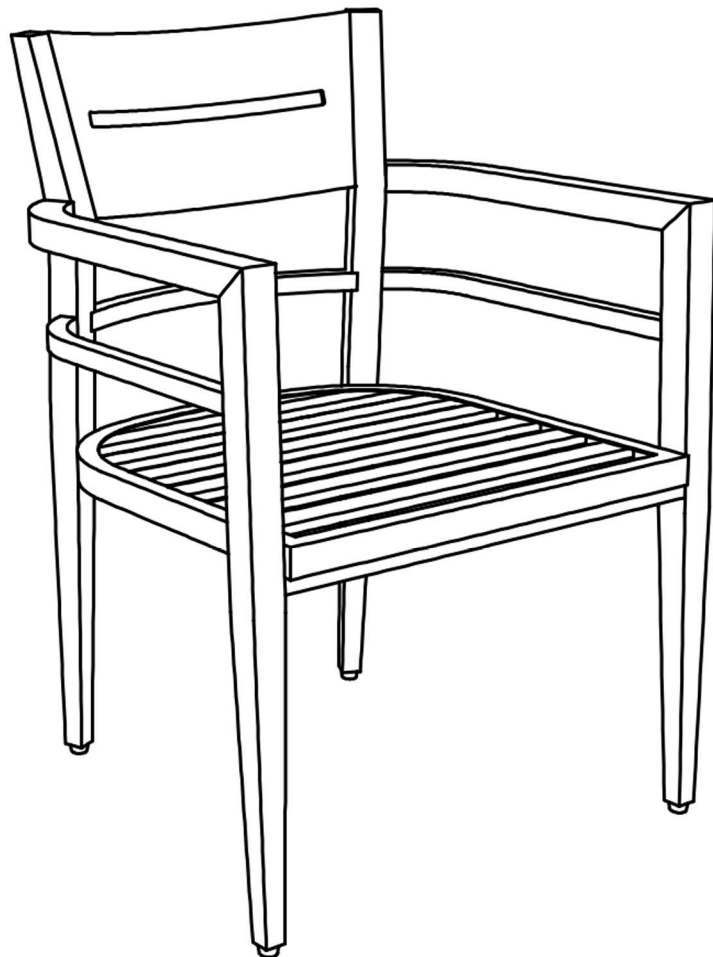



## ASSEMBLY INSTRUCTIONS

OE-H-570

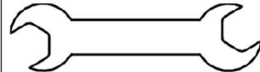

### BEFORE ASSEMBLY:

- Please read these instructions carefully before starting assembly. We suggest you carry out the assembly on a soft surface like a carpet, so as to avoid scratching the paint. Keep children away during assembly. This item contains small parts which can be swallowed by children.
- This product was made for the explicit purpose of providing outdoor function and is not to be used as a toy. This product is for residential use only. This product is NOT intended for commercial use; unintended use will void the warranty.
- This product is not intended for use during inclement or severe weather, that includes but is not limited to rain, hail, sleet, snow, wind, freezing conditions and extreme heat.
- Please note because of the nature of cast metal, you may find roughness on the surface which enhances the beauty of the product and is not a defect.
- Aluminum is soft metal, please do not use power tools, and over tighten may strip threads or break the parts.
- When not in use, store and/or cover the product in a cool dry location. Do not locate the product near any sort of high heat. Do not use the product as a support.
- Children under the age of 10, who are near the product, should be supervised by a competent adult at all times.
- Do not discard any of packaging until you finish the assembly. Keep the assembly instructions for future reference or warranty.

A × 4  Chair	B × 4  Seat	C × 8  Bolt(M6×20)
D × 8  Bolt(M6×30)	E × 16  Washer(M6)	F × 16  Bolt cap(M6)
G × 16  Lock Washer	H × 4  Wrench	I × 4  Cushion

# 1

**Step 1:** Place all the parts on a clean and soft surface, identify all the parts and hardware kits against parts list. Assemble front Legs and **Seat(B)** with parts(E,G,D,F). Assemble back Legs and **Seat(B)** with parts(E,G,C,F). Remember not to tighten all the bolts before they are all set up.

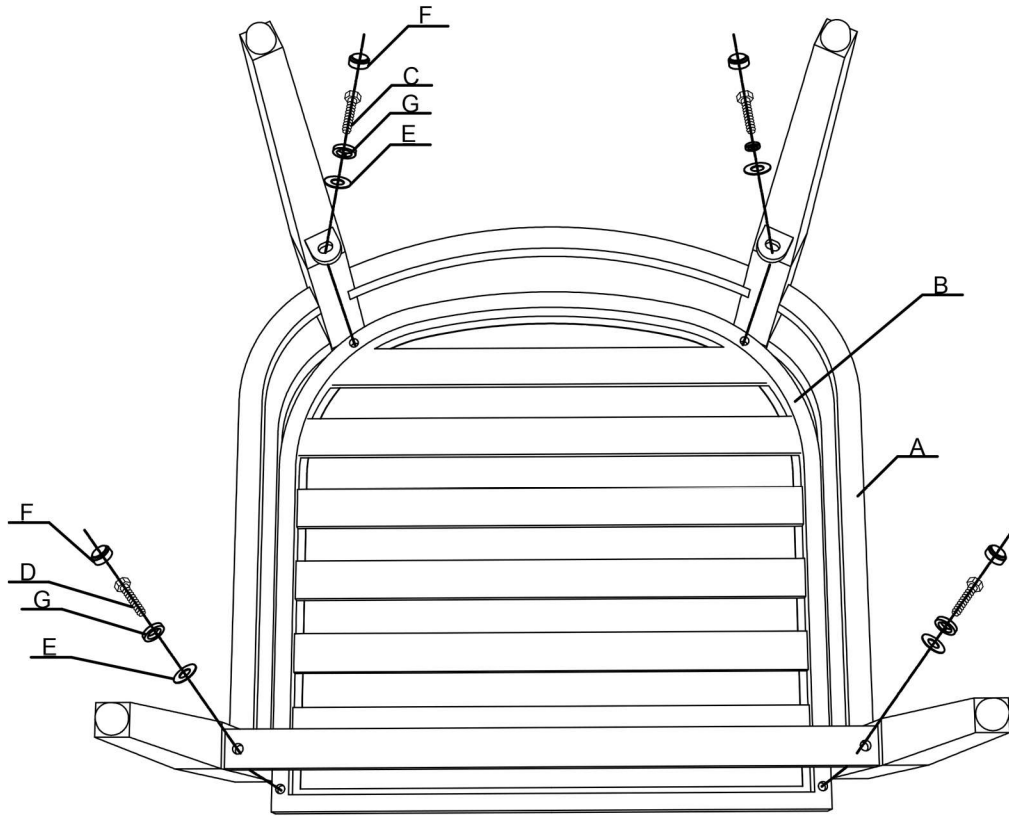

# 2

**Step 2:** Tighten all the bolts with **Wrench(H)**. Do not over tighten bolts, it will cause the damage of product without warranty. Then tight the cushion on the chair. Your chair should be ready for use.

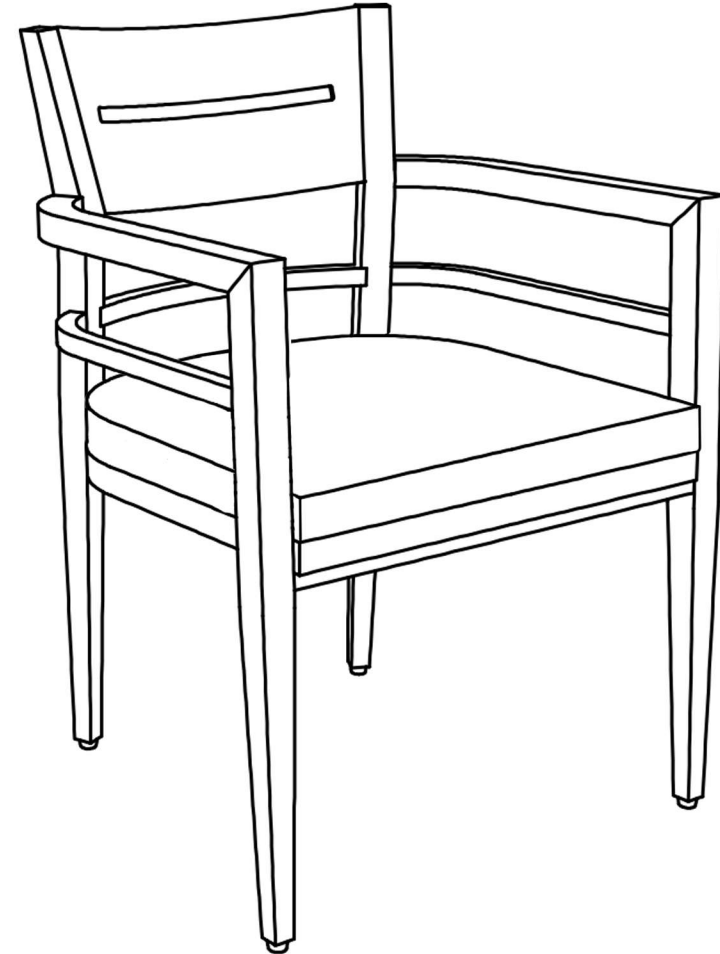

# Swivel Rocker





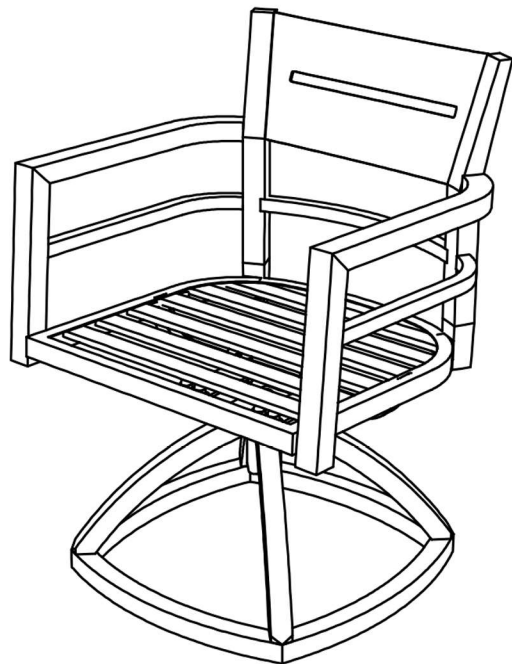



## ASSEMBLY INSTRUCTIONS

OE-H-571

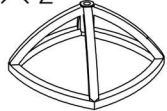

### BEFORE ASSEMBLY:

- Please read these instructions carefully before starting assembly. We suggest you carry out the assembly on a soft surface like a carpet, so as to avoid scratching the paint. Keep children away during assembly. This item contains small parts which can be swallowed by children.
- This product was made for the explicit purpose of providing outdoor function and is not to be used as a toy. This product is for residential use only. This product is not intended for commercial use; unintended use will void the warranty.
- This product is not intended for use during inclement or severe weather, that includes but is not limited to rain, hail, sleet, snow, wind, freezing conditions and extreme heat.
- Please note because of the nature of cast metal, you may find roughness on the surface which enhances the beauty of the product and is not a defect.
- Aluminum is soft metal, please do not use power tools, and over tighten may strip threads or break the parts.
- When not in use, store and/or cover the product in a cool dry location. Do not locate the product near any sort of high heat. Do not use the product as a support.
- Children under the age of 10, who are near the product, should be supervised by a competent adult at all times.
- Do not discard any of packaging until you finish the assembly. Keep the assembly instructions for future reference or warranty.

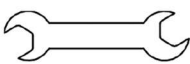
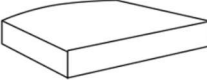
A×2  Seat	B×2  Connector	C×2  Base	D×4  Washer
E×8  Bolts(M8×35)	F×8  Nut	G×32  Nut Caps	H×8  Lock Washer
I×8  Washer	J×2  Wrench	K×2  Cushion	

# 1

**Step 1:** Place all the parts on a clean and soft surface, identify all the parts and hardware kits against parts list. Assemble **Seat(A)** and **Connector(B)** first, and make sure the direction of **connector(B)** is correct as Fig. This is very important for safe.

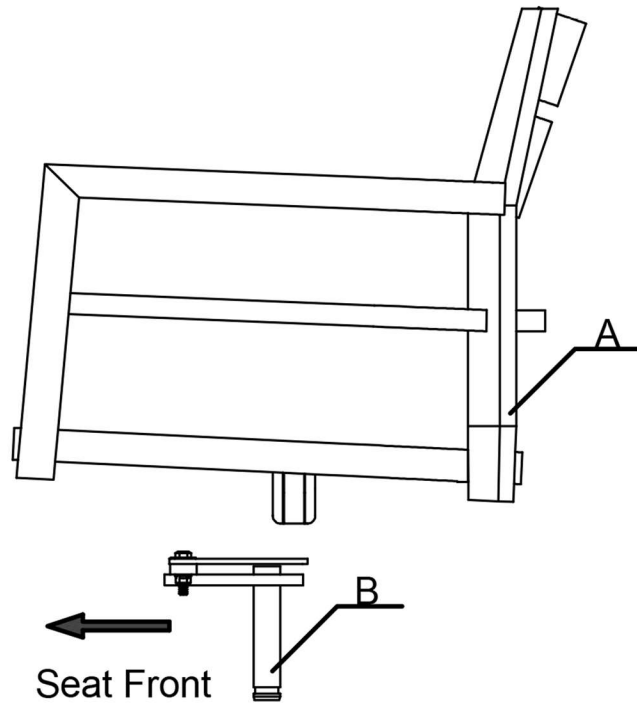

# 2

**Step 2:** Install hardware parts (D, E, G) and (I, H, F, G) in the order displayed in Fig. Do not tighten the bolts and nuts before they are all set up. Tighten all the bolts and nuts with **Wrench(J)**. Do not over tighten bolts and nuts, it will cause the damage of U-bar of **Seat(A)** without warranty.

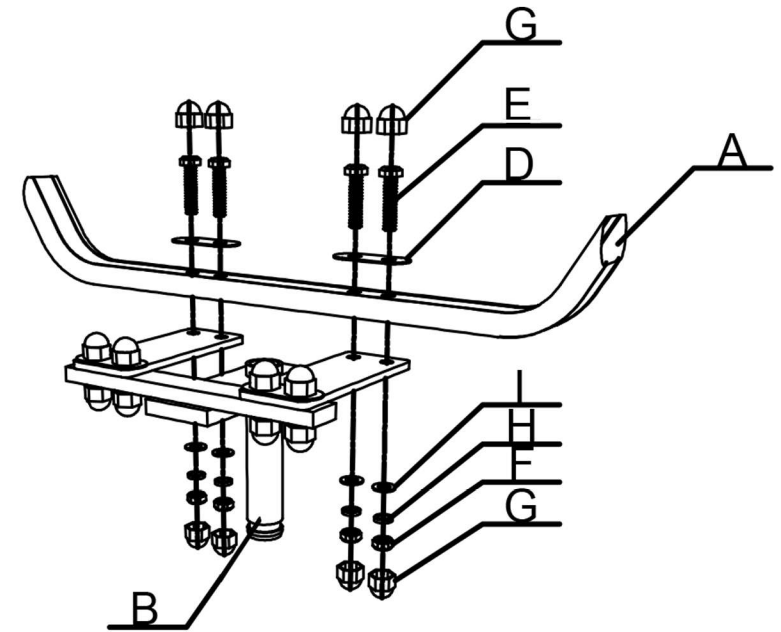

# 3

Step3 : Insert the installed rotating shaft into the **Base(C)** as Fig.

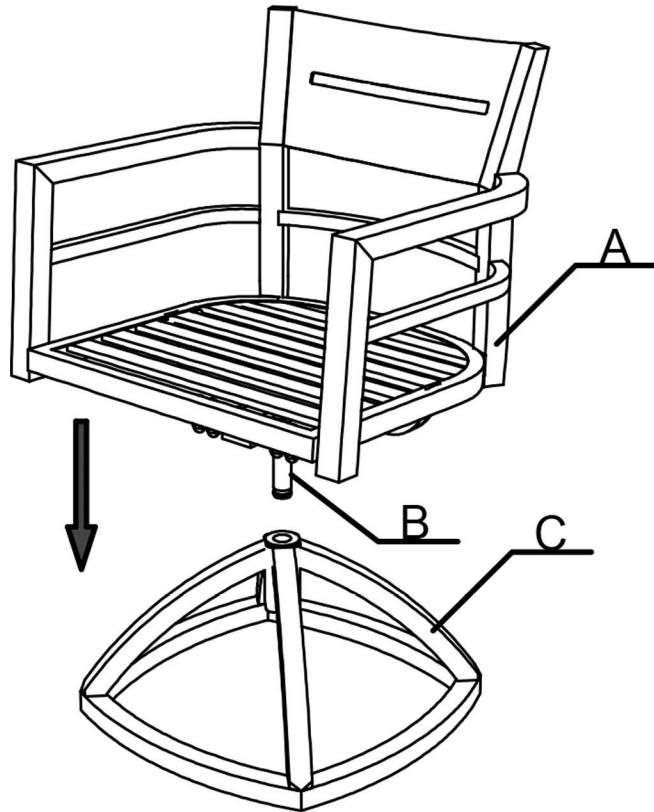

# 4

Step4 : Tie the **Cushion(K)**.Your chair should be ready for use.

