

Product manual



Firstly, regarding your purchase of our company's products,
Express our sincerest gratitude!

Please read this manual carefully before use,
In order to use the product correctly.

Contents

Material List	1
Installation and debugging	2
Toilet installation	3
Knob Function Description	4
Remote control diagram	5
Indicator light description	6
Seat ring function	7
Triangle valve cleaning method	8
Daily maintenance	9
Product specifications	11
Handling methods for cover plate faults	10
Important safeguard measures	12
Important safety instructions	13

Bill of Material

category	number
complete machine	1
Remote control	1
instructions	1
Plastic flange	1
Rubber flange	1
Hexagonal hose	1
Hexagonal triangular valve	1
Fixed flange screws	4
Ceramic fixing screws	2
Screw expansion seed	4
Screw decorative cover	2

Installation and commissioning

1. Open the angle valve

Remove debris from the tank duct

(Kind reminder: When opening for the first time, the angle valve handle has a large torque)

2. Power connection

Insert the power cord leakage protection plug into the power socket and press the reset switch. The plug indicator light is on, indicating that the power is turned on.

reminder:

Press the leakage test button before use, and the reset switch will pop up to indicate leakage

The protection function is normal.

Press the TEST button (then press the RESET button) to ensure normal operation every month

3. Self inspection

1. The host buzzer beeps and the display screen flashes; If the red light is on again, start the self check.

2. The host buzzer beeped again, completing the self check.

3. Normal use in startup function mode.

Toilet installation

Precautions before installation

Minimum dynamic working water pressure: 0.09 MPa or higher (3.96 gallons)/min (15L/min) or higher. Failure to meet this pressure will not achieve the best flushing effect.

Note: If you do not have a water pressure testing device, please use the following method

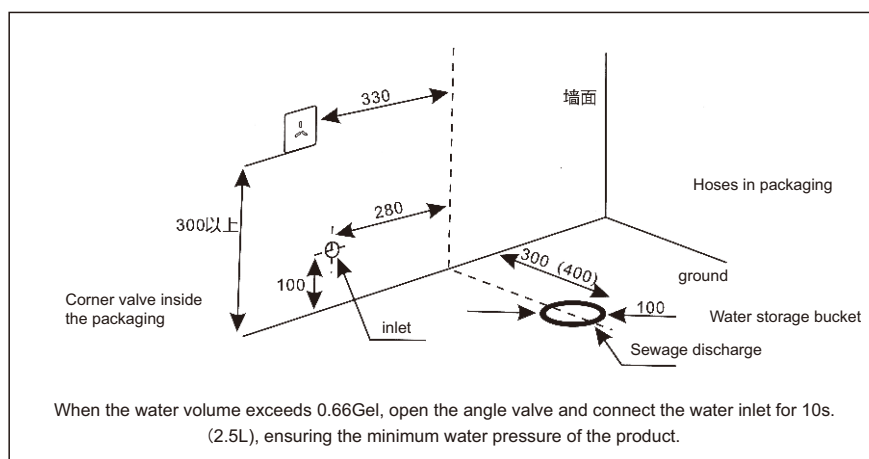

1. Installation of supporting angle valve

Draw the centerline of the drainage outlet on the floor and install angle valves at appropriate locations on the wall according to the size of the bathroom.

2. Cardboard installation

Align the cardboard with the centerline of the drain.

Draw contour lines based on the board.

3. Hoses

Connect and tighten the water inlet and corner valve of the bathroom with matching hoses.

4. Installation bracket installation

Assemble the installation bracket with bolts, then install it on the pre installed flange on the ground and lock it with nuts.

Knob Function Description

	cease	<p>1. Press and hold the "knob" button (3s) on the machine to enter shutdown mode (the display screen turns off), and then press the "stop" button to return the machine to working mode. In shutdown mode, except for the "stop" button on the host, any button (including the host and remote control) is invalid.</p> <p>2. When the user sits down, press the "Stop" button on the host to stop the female washing and hip washing and drying functions. When the user is not in the seat, repeatedly press the "stop" button on the host. The host flushes the toilet once.</p>
	Hip wash/ mobile wash	When people sit down, rotate clockwise once to clean their buttocks; Press the 'buttocks' button repeatedly to turn on/off the movement function; Press the 'Stop' button to stop. When a cycle of cleaning is completed and the body remains in place, the drying function will automatically turn on and stop after one cycle.
	Women's washing/ mobile washing	When people sit down, rotate clockwise once to clean the lady; Continuously press the "Clean" button, then turn on/off the mobile massage function; Press the 'Stop' button to stop. When a cycle of cleaning is completed and the body remains seated, the drying function will automatically turn on and stop after one cycle.
	dry	When the user is seated and pressed, the "Drying" button on the knob opens the "Drying" function. After 180 seconds of drying, it automatically stops. During the drying process, press the "Stop" button to stop the drying function.

Remote control diagram

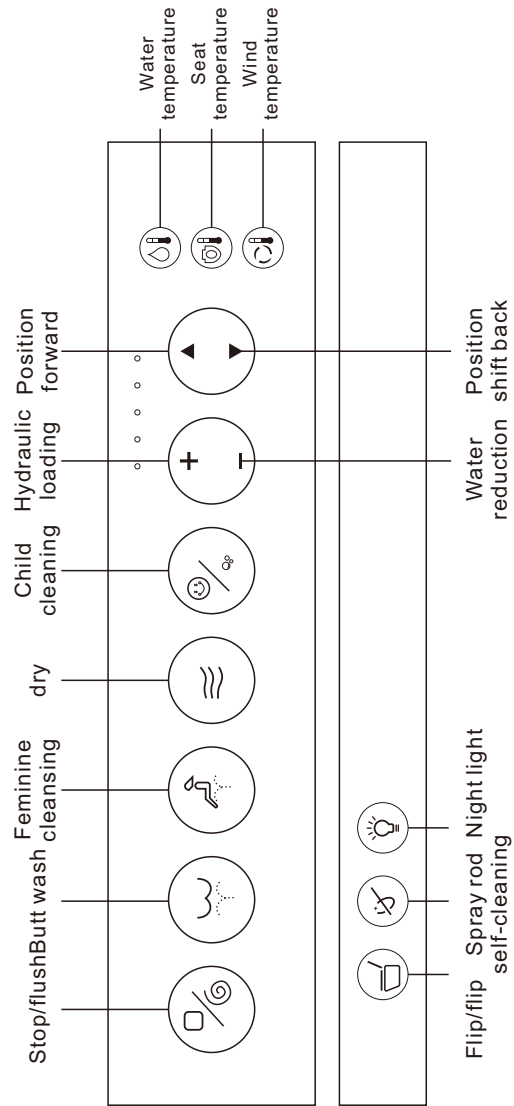

Matters needing attention:
 If the toilet you purchased has an automatic opening/closing function, the remote control is shown in the above picture.

LED

1. When the unit starts, the seat temperature will be displayed by default.
2. When adjusting the water temperature, the display screen shows the water temperature adjustment, and there is seat temperature adjustment.



Water temperature seat Seat temperature

Seat ring function

	Race	E16
Heating seat ring	surface temperature	4 Different levels of adjustment
	heating power	45W
	Opening and closing device	Silent soft shutdown device
	Heating combustion protection	The seat temperature automatically drops to level 1 within 10 minutes of use
Toilet flushing	Safety devices	Sensing area, temperature sensor, temperature fuse, over temperature protection, leakage protection plug
	Automatic cleaning	When the user leaves the toilet, the toilet will automatically flush
	Foot induction flushing function (optional)	Enable foot sensing flushing function

When the product is idle for a long time

Especially in winter when there is no one at home for a long time, please drain the water in the water tank and pipes to prevent freezing.

Start flushing and then close the angle valve to prevent water ingress.

2. Unplug and cut off the power supply

3. Dispose of the remaining water in the bowl

Suggest adding some antifreeze to the water in the bowl.

Reminder: When using the bathroom again, be sure to turn on the water and power supply



Note: Before discharging water, the power must be cut off!

Triangle valve cleaning method

Maintenance of filter screen

Maintenance time: Normal water pressure, but poor flushing performance

1. Turn off the power and angle valve
2. Unscrew the corner valve nut

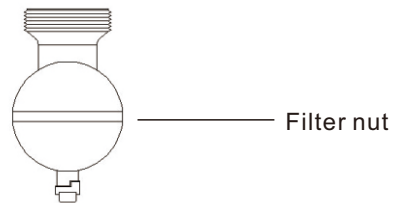

3. Removing the filter screen

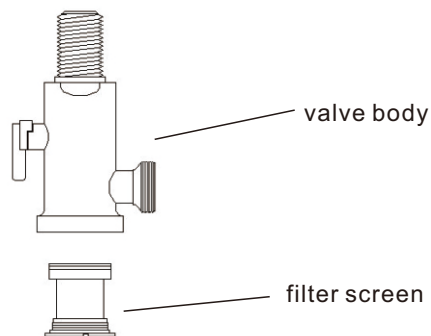

4. Use a brush to clean the filter screen
5. Flush and install filter screen and angle valve
6. Open the angle valve and connect the power supply. After self inspection, it can work normally.

Emergency troubleshooting

No water supply

Routine maintenance

Maintenance and upkeep of main equipment

1. Before conducting maintenance, please turn off the power supply.

2. Wipe off the stains with a soft damp cloth.

3. Safety self inspection

After cleaning, rinse and connect the toilet to the power supply.

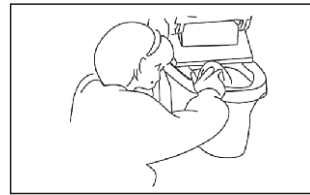

Maintenance and upkeep of nozzles

1. Nozzle self-cleaning

When not sitting on the machine, briefly press the "Back/Move" self-cleaning button on the host, the nozzle will extend outward, and water will flow out.

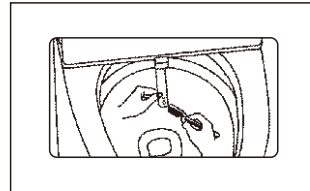

3. Clean with a soft cloth or brush

Do not pull or push the wand to avoid damage.

4. Nozzle retraction

Place the nozzle back in front of the boom and press the "Stop" button to automatically retract the nozzle.

Product specifications

Main unit	Rated voltage	110V to 120V, 50V to 60Hz
	Rated power	1500w
	Overall unit waterproofing	IPX4
	wire	Approximately 1.5 meters in length
toilet	Flushing volume	1.6/1.1Gpf (full flush 6.0h)
	Flushing mode	Siphon jet
	Rough machining distance	305 mm
	Outlet outer diameter ≤ 100mm	
	Drainage method	Undershoot
	Water pressure range	0.09Mpa (dynamic water pressure, flow rate), 3.96 gallons per minute (15.0 liters per minute or higher) -0.8Mpa (hydrostatic pressure)
cleaning device	Heating method	Immediate heat
	heating power	1500W
	water temperature	93°F 98°F 105°F
	Water volume	
	Cleaning mode	Water column cleaning
	Three different levels of adjustment for spray cleaning positions	
	Water pressure protector	
	Anti fouling device	Automatic cleaning spray, anti siphon device, anti backflow device, filtering device
	Safety devices	Temperature fuse, water temperature sensor, grounding protection temperature controller, over temperature protection, leakage protection plug
Drying device	Heating air volume	Above 0.2 cubic meters per minute
	Heating temperature can be adjusted at four different levels	
	heating power	250W
	Safety devices	Temperature fuse, temperature sensor, temperature controller

Handling methods for cover plate faults

problem	reason	Solution
There is no water in the nozzle	Blockage caused by bent water inlet hose	Solve the problem of water inlet hose bending
	Inlet valve closed	Open the inlet valve
	Water supply cut off	Press the water supply system and wait for water supply
Weak water cleaning	The water inlet hose is bent, causing partial blockage	Solve the problem of water inlet hose bending
	Inlet valve not fully open	Fully open the inlet valve
	Inlet filter clogged	Clean the filter
water temperature is low	Set the water temperature to the normal temperature level	Reset water temperature
Low valve seat temperature	The valve seat temperature is set at the normal temperature level	Reset seat temperature
	In standby mode	Switch to feature mode and use it for 3 minutes before using it
Low wind temperature	Set the wind temperature at the normal temperature level	Reset wind temperature
no wind	In standby mode or power saving mode	Switch to feature mode to use dry function
The spray rod cannot be retracted	power failure	Gently push the spray bar back
	Stuck by impurities	Clear impurities
The spray rod cannot extend	power failure	restart
	Not sitting in the sensing area	Sitting in the sensing area
Remote control cannot display	Reverse the polarity of the battery	Replace the battery again
Adjust to reach the sensing area		
 warn	If the above method still cannot solve the problem, please turn off the power and contact the service provider for repair.	
	If the leakage circuit breaker frequently trips, it indicates that the product has leakage. Please turn off the power and contact the service provider for repair.	

Important safeguard measures

When using electrical products, especially when children are present, basic safety precautions should always be followed, including the following:

1. This device is not allowed to be used by weak individuals (including children). Sensory or spiritual abilities, or lack of experience and knowledge, unless they receive supervision or guidance.
2. Children under guardianship are not allowed to play with this device. Children aged 3.8 and above, as well as individuals with decreased physical, sensory, or mental abilities or lack of experience and knowledge, may use this device if they have received supervision or guidance on the safe use of this device and are aware of the hazards involved.
4. Children are not allowed to play with this device.
5. Children should not undergo cleaning and user maintenance without supervision.

Please read all instructions before use



Hazard - Reducing the risk of electric shock:

1. Do not use when taking a shower.
2. Do not place or store the product in areas where it may fall or be pulled into the bathtub or sink.
3. Do not put or drop into water or other liquids.
4. Do not reach out to remove products from the water. Immediately unplug the plug.
5. Do not use water or cleaning agents to clean the host or electrical plug.
6. Do not touch the power plug with wet hands.
7. Do not place your hands or other personnel on the outlet of the air dryer or block the outlet of the air dryer.
8. Do not disassemble, repair, or modify this product.
9. During the installation, disassembly, repair, and maintenance of the product, the power plug must be turned off and the water source must be cut off.



Warning - Reduce the risk of burns, electric shock, fire, or personal injury.

1. When using this product by children or people with disabilities, or in the vicinity of children or people with disabilities, close supervision is necessary.
2. Use this product only for the intended purpose described in this manual. Do not use attachments that are not recommended by the manufacturer.
3. If the power cord or plug is damaged or cannot function properly, please do not operate this product. If it has dropped or damaged, or fallen into the water. Return the product to the service center for inspection and repair.
4. Keep wires away from heated surfaces.
5. Never use it while sleeping or drowsy.
6. Do not drop or insert any objects into any openings or hoses
7. Do not use or operate the aerosol outdoors where the product (spray) is being used or where oxygen is being used.
8. Only connect this product to a properly grounded socket. Please refer to the grounding instructions.
9. Do not throw cigarettes and other combustibles into the toilet, as this may cause a fire.
10. This product is an electrical appliance, please stay away from water. Please do not pour urine or other liquids onto it.
11. During circuit operation, do not lie flat on the side or top of the product.
12. It is prohibited to use other electrical appliances within the same socket.
13. It is strictly prohibited to use power extenders or unstable loose sockets.
14. Old and aged water supply hoses cannot be used, otherwise they may cause water leakage, fire, or electric shock. The installation of the bidet seat should include designated components and new water supply hoses.

Important safety instructions



Attention - Failure to follow the instructions may result in physical injury or property damage.

1. Do not install or use this product in damp areas such as steam rooms.
2. It is recommended to use a waterproof power socket and install it in a place that is not easily affected by moisture.
3. This product is only suitable for currents of 110V-120V, 50/60Hz, with a load current of at least 15A. The power plug must be equipped with a ground fault circuit breaker or ground fault leakage protector or similar high sensitivity, fast type leakage switch (rated sensitive current below 6mA).
4. When lightning strikes, it is strongly recommended to unplug the power plug.
5. Do not stand on a ceramic toilet.
6. Ceramic bathrooms must be equipped with floor fixing bolts.
7. Do not stand on product units, seats, or covers.
8. When using this product, do not lean against the seat cover to avoid damage.
9. This product is equipped with a soft closing sealing cover. Pressing or pushing hard may damage the soft closing damper.
10. Do not use paint thinners, gasoline, liquids, cleaning agents, insecticides, toilet cleaners, and drama cleaning products.
11. Do not expose to direct sunlight.
12. Only tap water or drinking water should be used, otherwise it may cause scratches.
13. Do not connect the outlet of the water heater to the water heater. Ensure that the inlet water temperature is between 3-35°C/37.4-95°F.
14. When the room temperature is below zero, please dry the water tank to avoid freezing.
15. Increase the temperature of the rest room to prevent damage to the toilet due to freezing.
16. When moving the product from a cold or humid environment to normal room temperature, wait for 2 hours until the condensate has completely evaporated. This can prevent electrical short circuits in the product.
17. When the product is not used for more than three (3) days, drain the water from the container and unplug the power plug from the wall socket.
18. When the product malfunctions, please stop using and turn off the power. Please contact service personnel for professional repair.

ground indication

This product should be grounded. In the event of an electrical short circuit, grounding reduces the risk of electric shock by providing a current escape wire.

This product is equipped with a grounding wire with a grounding plug. The plug must be inserted into a properly installed and grounded socket.



Danger - Improper use of grounding plugs may lead to electric shock hazards.

If it is necessary to repair or replace the power cord or plug, please do not connect the grounding wire to any flat blade terminal. The outer surface of the insulated wire is green, with or without yellow stripes as the grounding wire.

This product is shipped with specific wires and plugs to allow connection to appropriate circuits. Ensure that the product is connected to the same socket configuration as the plug. This product should not use any adapters. Do not modify the provided plug. If it is not suitable for the socket, please have a qualified electrician install the appropriate socket. If the product must be reconnected for use on different types of circuits, reconnection should be carried out by qualified service personnel.

Save these instructions

Remote control installation

Remote control hanger installation

1. Wipe the wall with cloth to ensure that there is no dust and no water before installation.
2. Take the base of the remote control, tear the 3M glue on the back, stick it on the wall, and press hard to ensure that the 3M glue is completely stuck on the wall, and ensure that the end user can get the remote control while sitting on the seat.

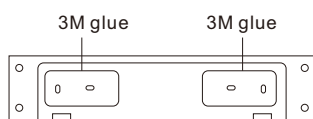

3. install the battery, and put the remote control on the hanger.

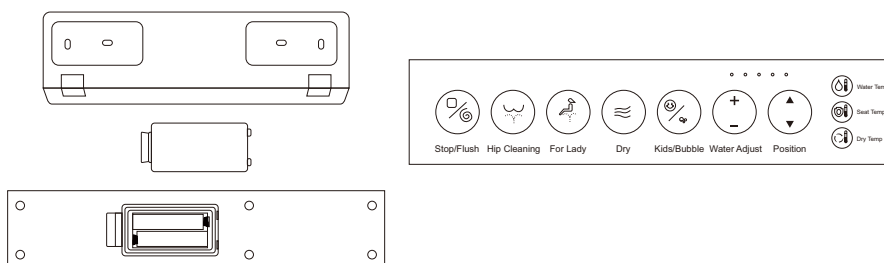

Note:

Please do not install or use the product in damp places such as steam rooms, and do not place it in places prone to humidity.



clamshell

Automatic Valve cover opening/closing (only for toilets with this feature)

Press the "flip" button to close the seat cover.

Press the "flip" button to open the lid and close the seat.

Press the "flip" button to open the lid and seat ring.

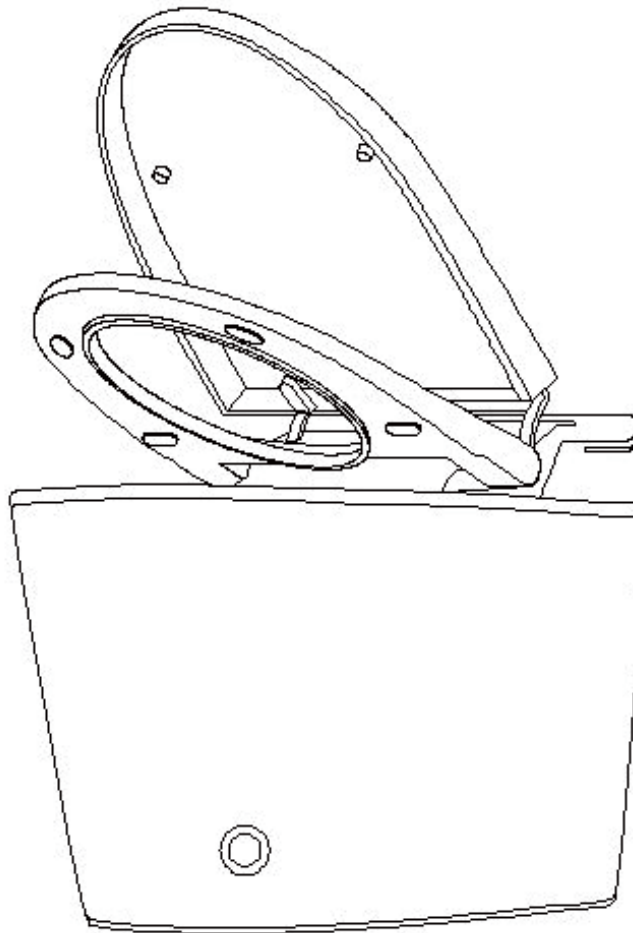

Nozzle cleaning

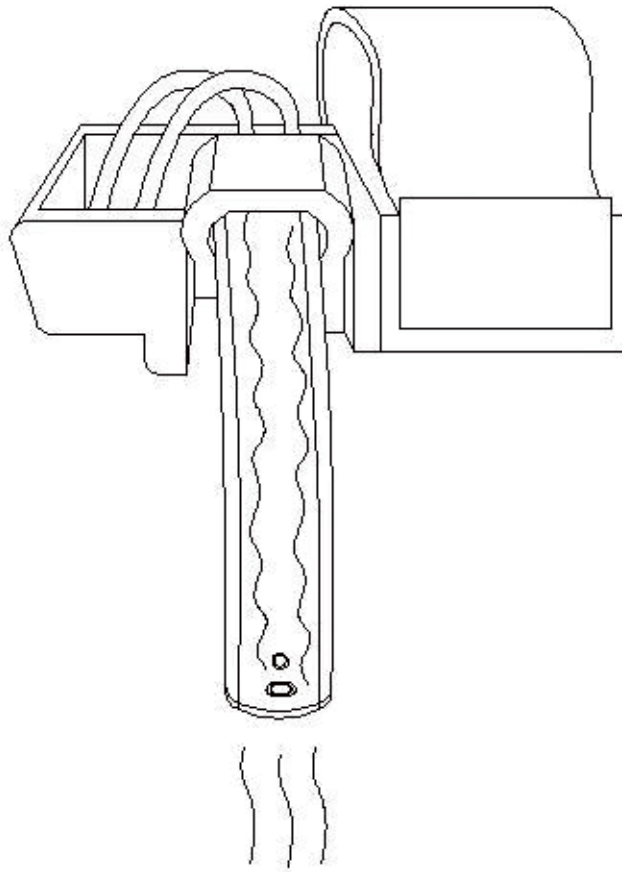

self-cleaning

Gently press the self-cleaning key to clean:
Quickly press the "Self-cleaning" button,
and the nozzle automatically cleans for a
period of time and moves to the front
position. People can continue to manually
clean the nozzle.

Set automatic function

Set the automatic cleaning function

The default setting of automatic function is two-stage water pressure, two-stage nozzle position, two-stage water temperature, wind temperature and seat temperature. The massage function is turned off, and users can reset it according to their personal preferences.

1. Adjust water pressure, nozzle position and temperature through seat temperature, wind temperature, water temperature, forward and backward, and turn on/off the massage function.

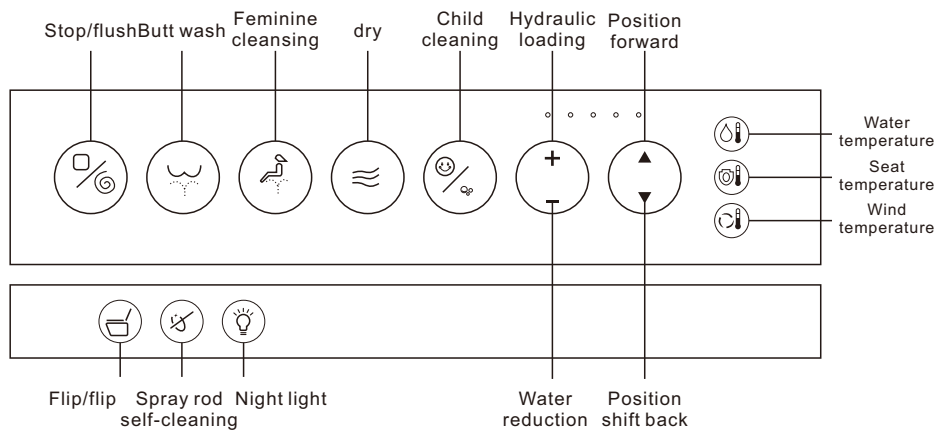

2. After the above steps, the toilet is cleaned for 90 seconds after operation, and then automatically dried for 180 seconds without pressing other buttons.

3. Users can still change the level, temperature and massage status during the automatic post-cleaning process.

Butt wash

Press the "butt" button and water flows out of the water stick to clean the butt. After one cycle of cleaning, it stops automatically. If the "Stop" button is pressed while in use, the feature will stop immediately.

Reciprocating massage

Press the "hip" button to start the cleaning function, press the nozzle again to move back and forth to expand the cleaning range, and press the "Stop" button again to stop the function.

Drying operation

Press the "Dry" button and the warm air will blow dry. It stops automatically after a loop or after the user leaves the seat.

(Note: Using toilet paper to absorb water droplets before drying can speed up drying)

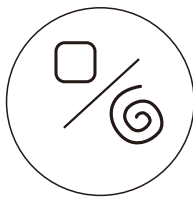

Stop/flush



buttocks



Female washing

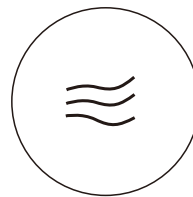

dry

Nozzle position adjustment

In "back" or "front", press the nozzle button.

" ◀ " and " ▶ ", by adjusting 5 levels to move the position back and forth.

Water pressure adjustment

In "back" or "front", press the water pressure button of "+" and "-" to adjust the front and rear cleaning pressure.

Water pressure on
the spray rod

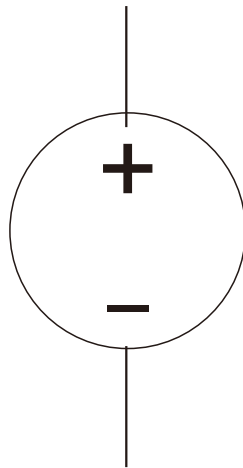

Spray rod water
reduction

Spray rod
position plus

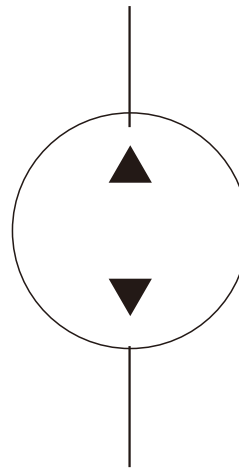

The spray rod
position is reduced

Temperature regulation



Water temperature seat Seat temperature

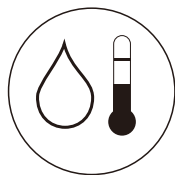

Water

temperature Press the water temperature button and turn the water temperature up 1 gear once. One light on the remote control is normal temperature, three light on is 93°F, four light on is 95°F, and five light on is 105°F.

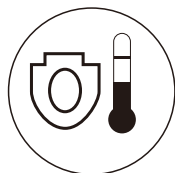

Seat

temperature Press the seat temperature button and turn the seat temperature up 1 gear once. One remote control light on is normal temperature, three light on is 93°F, four light on is 95°F, and five light on is 105°F.

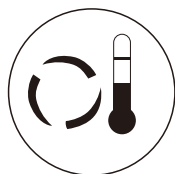

Wind

temperature Press the air temperature button and turn the air temperature up 1 gear once. The light on of the remote control is normal temperature, the light on of 3 is 93°F, the light on of 4 is 95°F, and the light on of 5 is 105°F.