

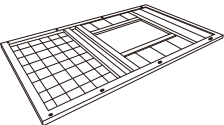

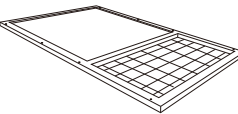

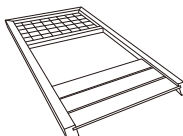

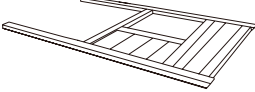

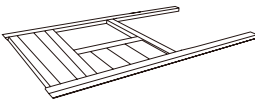
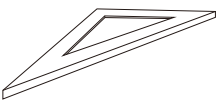
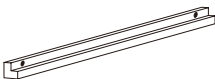
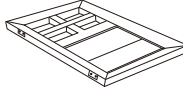
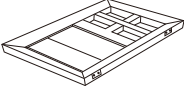

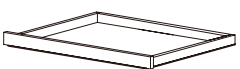
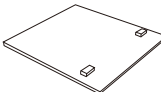
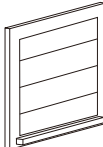
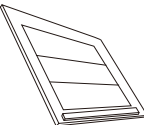
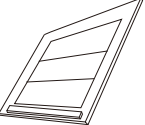

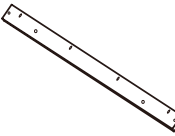
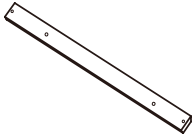

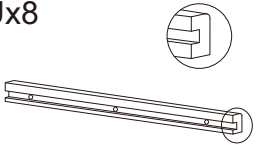
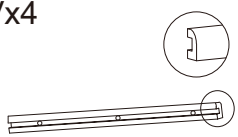
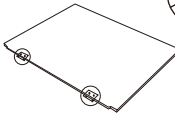
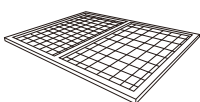
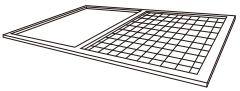
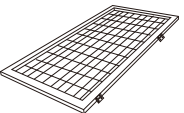
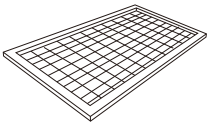
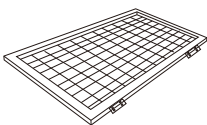



SKU : W1625S00005

Ax2 	Bx2 	Cx2 	Dx1 	Ex1 
Fx4 	Gx4 	Hx1 	Ix1 	Jx2 
Kx2 	Lx4 	Mx2 	Nx2 	Ox2 
Px2 	Qx2 	Rx2 	Sx2 	Tx4 
Ux8 	Vx4 	Wx2 	Xx2 	Yx2 
Zx2 	AAx2 	ABx1 	S1x60  M3x $\frac{30}{1.2}$	S2x46  M3x $\frac{25}{1.0}$
S3x24  M3x $\frac{20}{0.8}$	S4x52  M2.5x $\frac{18}{0.7}$	S5x16  M2.5x $\frac{12}{0.5}$	S6x50  M2x $\frac{10}{0.4}$	S7x4 
S8x4 	S9x5 	S10x4 		 mm inch x2

SKU : W1625S00005

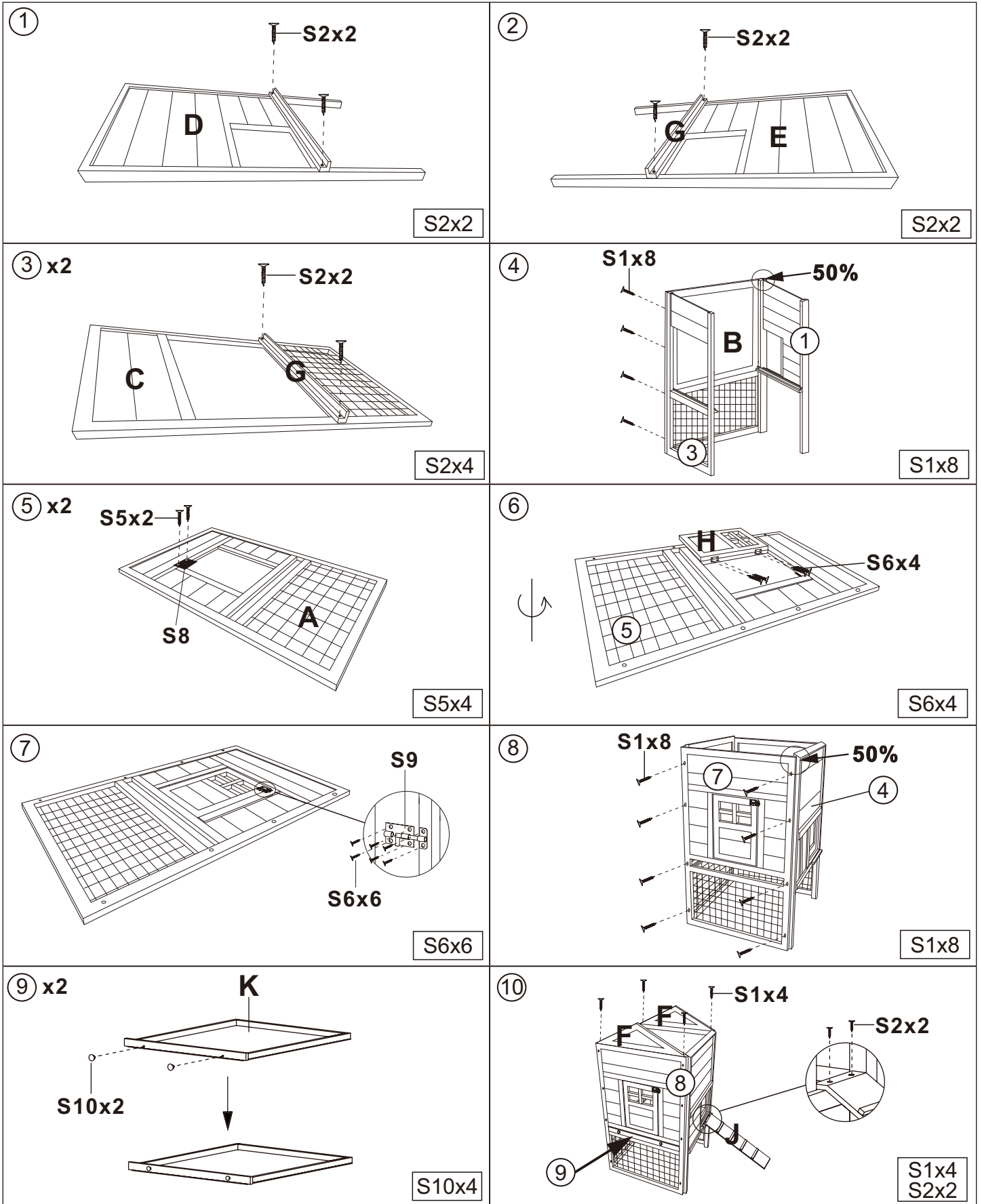

SKU : W1625S00005

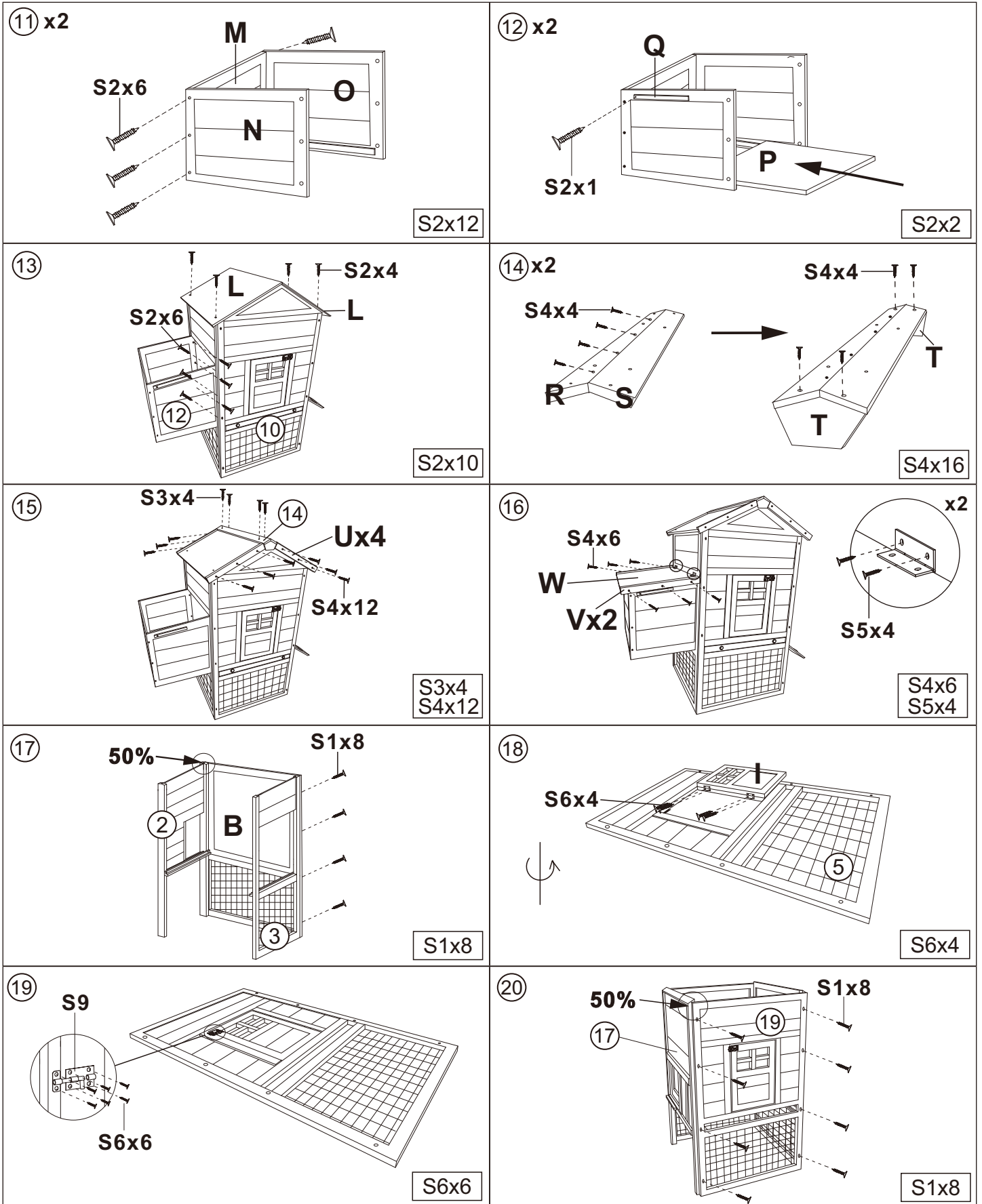

SKU : W1625S00005

