

W1625S00004

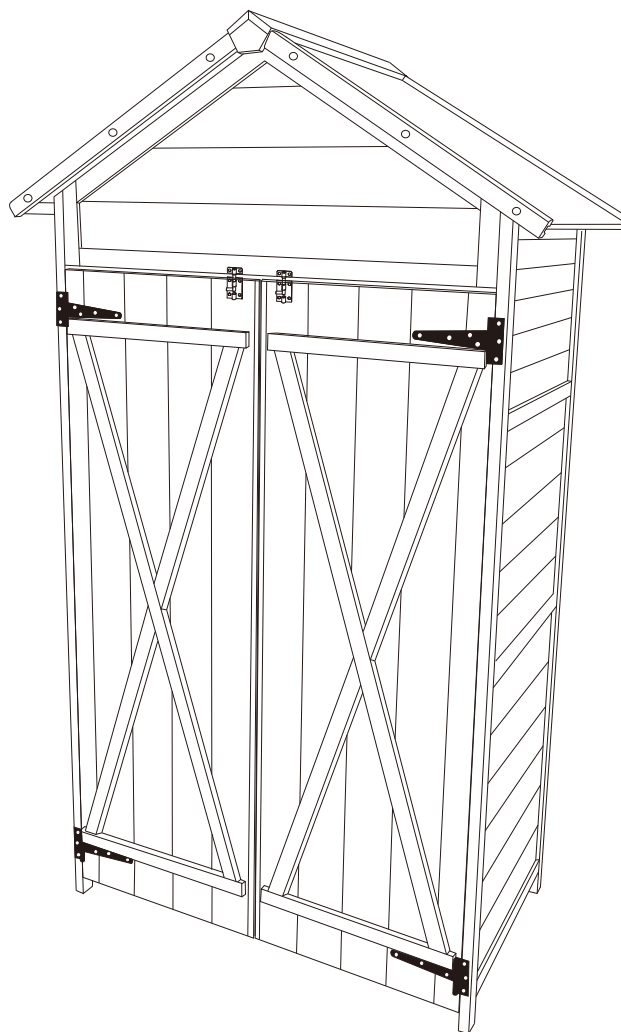

EN_IMPORTANT, RETAIN FOR FUTURE REFERENCE: READ CAREFULLY.







**FR_IMPORTANT: A LIRE ATTENTIVEMENT ET À CONSERVER POUR CONSULTATION
ULTÉRIEURE.**

ES_IMPORTANTE, LEA Y GUARDE PARA FUTURAS REFERENCIAS.

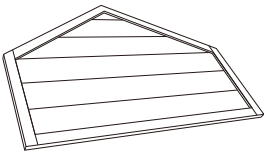
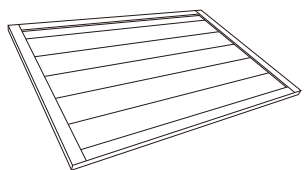
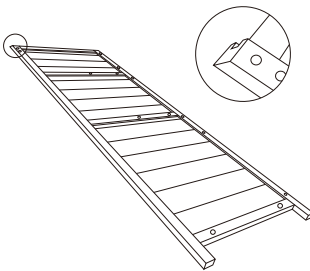
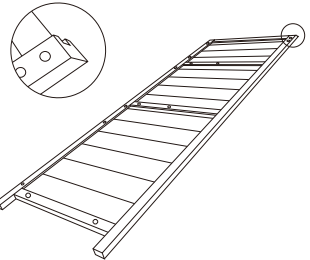
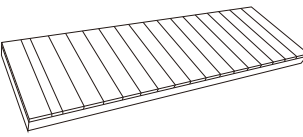
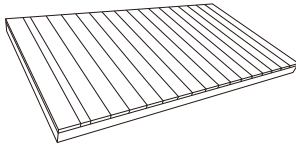
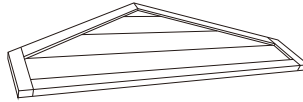
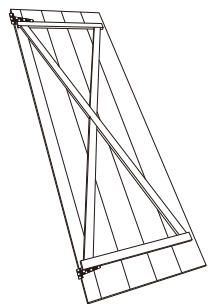
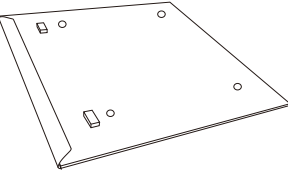
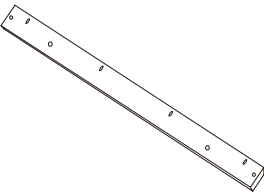
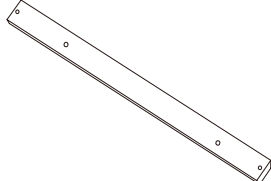
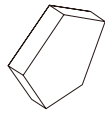
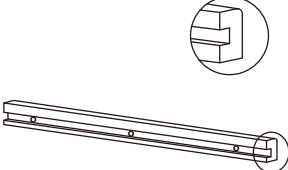
DE_WICHTIG! SORGFÄLTIG LESEN UND FÜR SPÄTER NACHSCHLAGEN AUFBEWAHREN.

**IT_IMPORTANTE! CONSERVARE IL PRESENTE MANUALE PER FUTURO RIFERIMENTO E
LEggerlo ATTENTAMENTE.**

SKU : W1625S00004

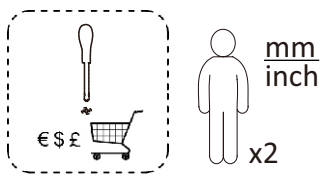
<p>Ax1</p> 	<p>Bx2</p> 	<p>Cx1</p> 	<p>Dx1</p> 
<p>Ex2</p>  <p>SIZE: 85.5x24cm</p>	<p>Fx1</p>  <p>SIZE: 85.5x44.5cm</p>	<p>Gx1</p> 	<p>Hx2</p> 
<p>Ix2</p> 	<p>Jx1</p> 	<p>Kx1</p> 	<p>Lx2</p> 
<p>Mx4</p> 	<p>S1x28</p>  <p>M3x $\frac{30}{1.2}$</p>	<p>S2x12</p>  <p>M3x $\frac{20}{0.8}$</p>	<p>S3x20</p>  <p>M2.5x $\frac{18}{0.7}$</p>
<p>S4x12</p>  <p>M2.5x $\frac{15}{0.6}$</p>	<p>S5x12</p>  <p>M2x $\frac{10}{0.4}$</p>	<p>S6x2</p> 	 <p>mm inch</p> <p>x2</p>

SKU : W1625S00004

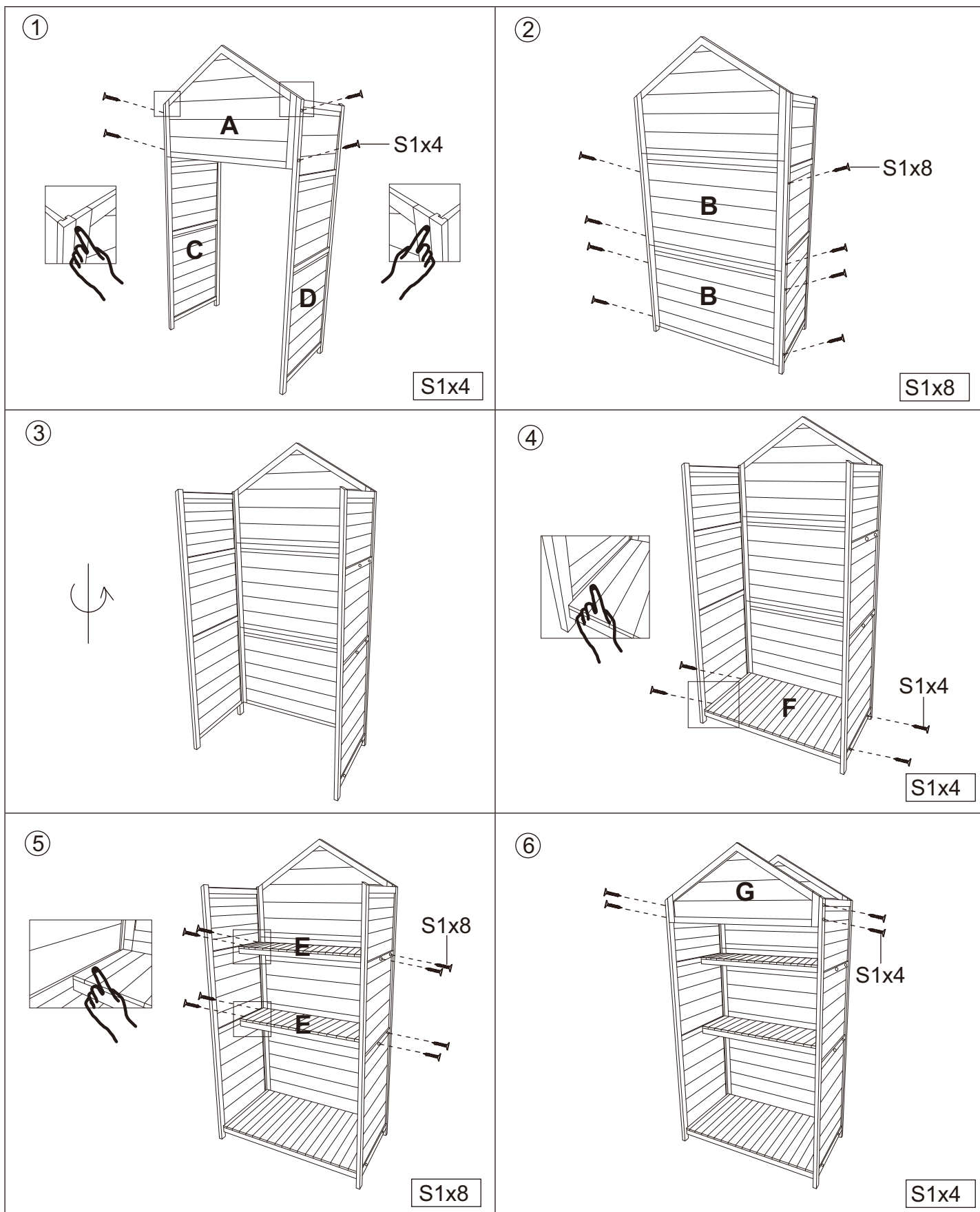

SKU : W1625S00004

