



CAUTION

- Risk of personal injury. Bath tubs can be extremely heavy. Obtain sufficient help to carefully lift or move the bath tub.
- Risk of property damage. Make sure that a watertight seal exists on all bath drain connections.

## TOOLS

YOU MIGHT NEED



## BEFORE INSTALLATION

- Before installation check that all fittings have been supplied.
- Assembled bath on a mat to protect against damage to bath surface.
- This product requires a two person lift-use proper lifting techniques.
- This installation guide recommends a bath waste be fitted to the bath prior to installation - if any doubt about Installation and waste connection
- please consult a qualified tradesmen
- Follow each step in turn.

**IMPORTANT:**All installations must comply with council and local authority by-laws. It is the responsibility of the installer to ensure that the waste is made watertight by means of silicone sealant or caulking compound.

**NOTE:** Bath can be installed after the wall & floor tiling is completed. Bath drain supplies should be arranged preliminarily according to the selected bath.

## WARNING



**CAUTION**

Ensure the floor where the bath will sit is level.

The waste & overflow is supplied with the product, however other items required such as a waster trap and connectors are not supplied and must be purchased and must be purchased separately.

Because of the technical features of the product it should only be used with the waste & overflow supplied.

Handgrips for this product are not available.

The bathtub must be carried upside down, do not life or support the bath by the sides.

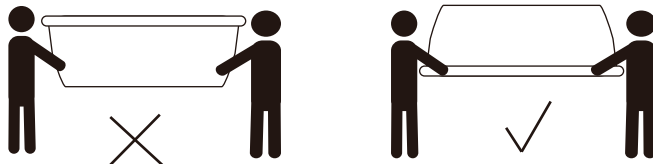

Prior to installing the bath should be checked for damage as we recommend all work is to be carried out by a qualified person.

## INSTALLATION PROCEDURE

1

Place the bath upside down on a dust sheet or soft cloth so not to scratch the surface. Level the feet on the base of the bath and lock them into place.

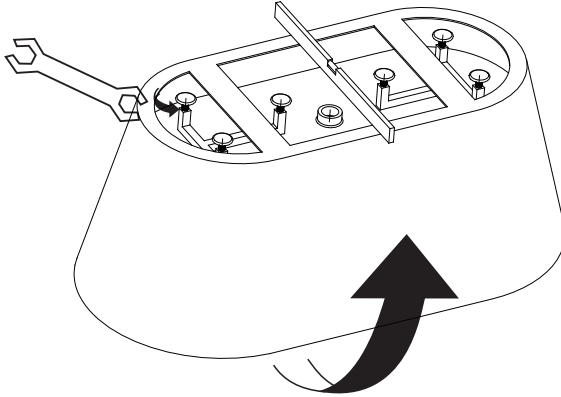

2

Turn the bath over and temporarily place in what will be final position in the bathroom. Check along the top of the bath using a spirit level and adjust the feet if necessary and lock into place.

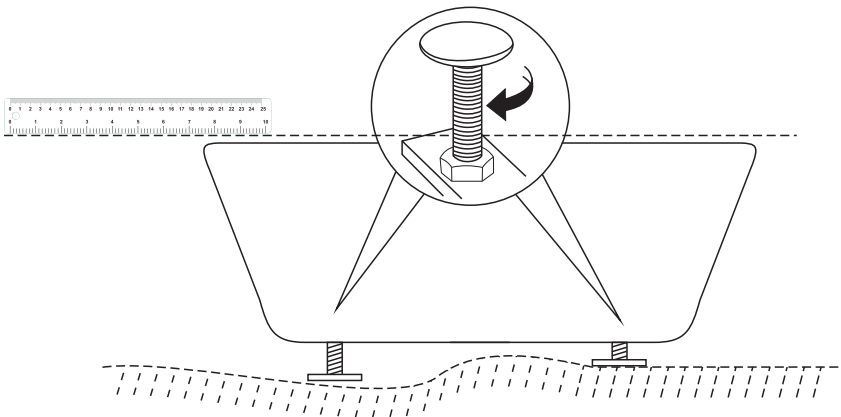

## INSTALLATION PROCEDURE

**3**

Turn the tub upside down and install a drain line in the tub according to your home's sewer configuration

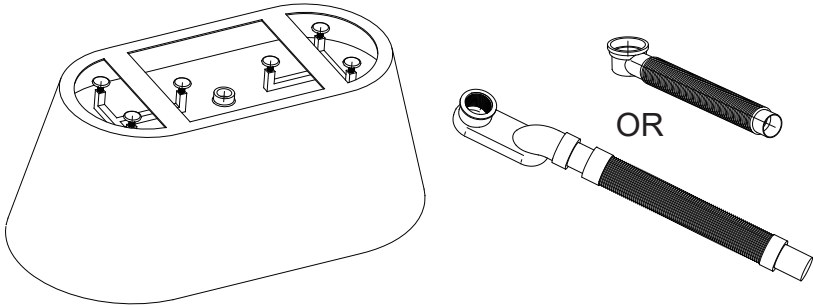

**4**

Turn the bath the right way up and rest on two blocks(ideally4"x4")in position to gain access underneath to attach the household pipework.

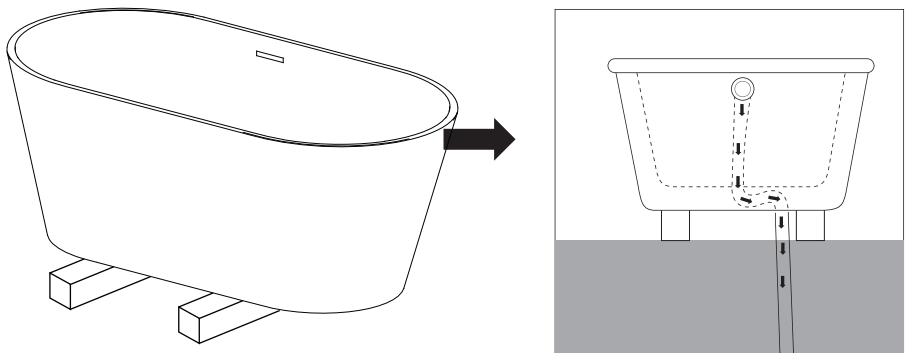

## INSTALLATION PROCEDURE

**5**

Once the waste option has been chosen and attached to the household pipework water should be poured through the waste to check for leaks. Once this has been done apply silicon to the underside of the bath to complete the look.

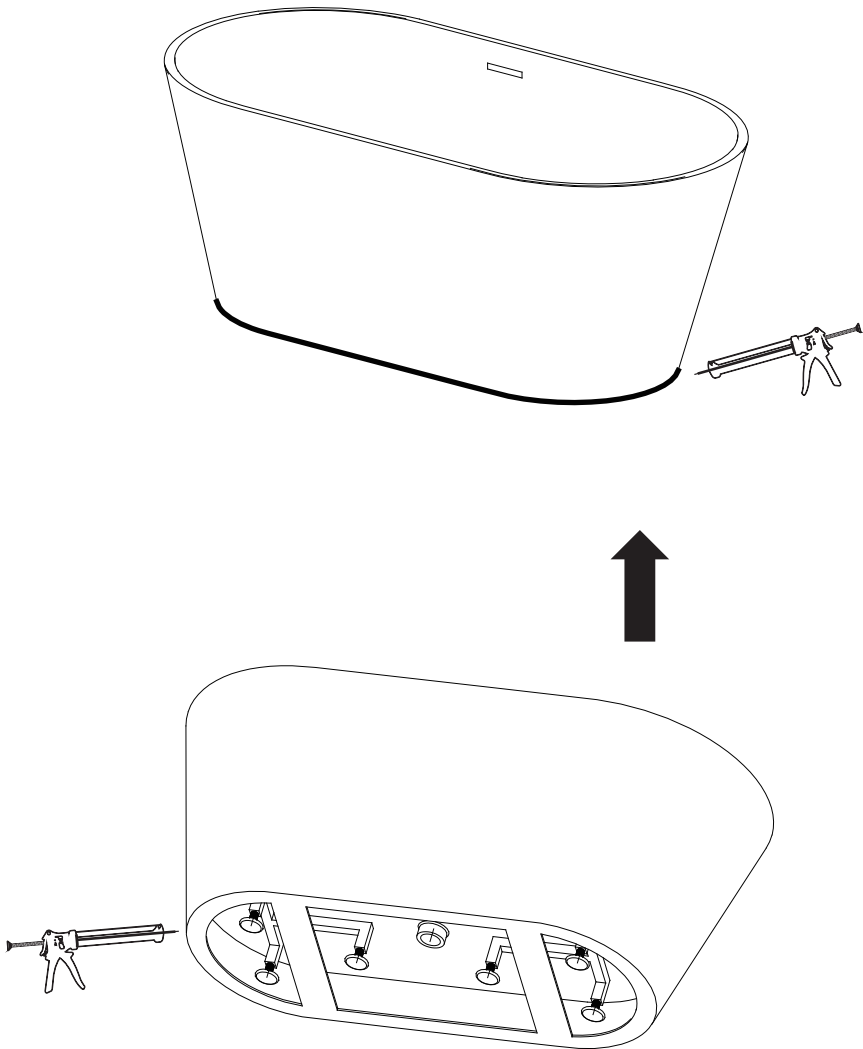

**6**

Please allow 24 hours for the silicon to dry off before use. The installation guide includes options for waste connection: The final decision about installation and waste connection should be taken by a qualified person.

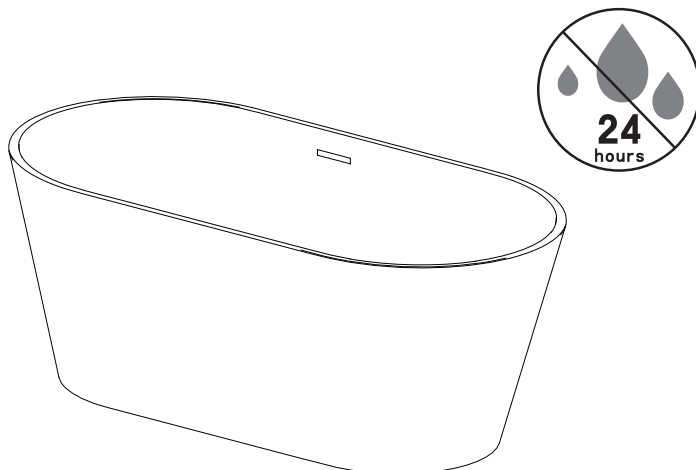

## AFTER INSTALLATION

Run water into the bath and check connections for leaks.

## CARE & CLEANING

- Use a soft cloth or sponge for cleaning .Don not use any scouring pads like pot cleaners etc. as this will dull the surface
- Use mild soap and water for everyday use.
- Do not use any abrasive cleaning materials.
- Do not use any disinfectants, aerosol cleaners, ammonia concentrates etc.
- Every few months give your bath a light polish with LIBRA acrylic polish to restore the original sheen.

## ALWAYS

- Clean every day by thoroughly rinsing with mild soap and warm water and wipe dry with a cloth.
- Keep the tub free of any standing water as this can cause a buildup of mineral deposit, which can affect the appearance of your sink.
- Always rinse the bathtub after using any cleaning agent and wipe dry with a cloth . Clean any mineral deposits built up over time with a mild solution of vinegar and water followed by thorough flushing with water.

## NEVER

- Use steel wool or a scouring pad as it damages the sink surface and causes discoloration.
- Let household cleaning agents or bleach sit in your bathtubs for a long period as this may ruin the finish of your sink.
- Leave rubber mats ,sponges , or cleaning pads in the bathtub for long periods as this may damage the finish of your tub.
- Use the inside of the tub as a cutting surface.

## NOTE

- **The uneven surface** --- To finish polishing a bathtub , we usually apply wax to make it shine and protect it from stains and scratches . However , the extra wax will eventually generate an uneven surface . Before using it , please use a clean cloth with warm water in circular motions to lightly wipe the surface to remove the extra wax.
- **The water stain** --- To finish testing the bathtub overflow, we usually inspect the bathtub overflow drains by running water down the drains to test if there is any leak at the overflow . Therefore, water stains may be found on the surface of the bathtub.