

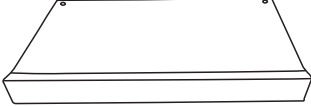

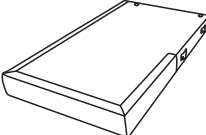
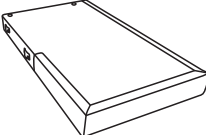

Assembly Instruction

NO	PARTS	QTY
A		1 PC
B		1 PC
C		1 PC
D		1 PC
E		1 PC
F		1 PC
G		1 PC
H		1 PC
I		2 PCS
J		2 PCS
K		2 PCS

NO	PARTS	QTY
L		2 PCS
M		2 PCS
N		2 PCS
O		12 PCS
P		24 PCS
Q		12 PCS
R		12 PCS
S		1 PC

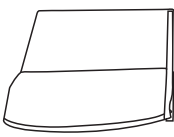
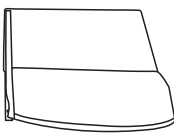
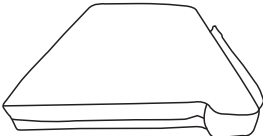
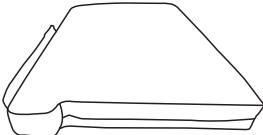
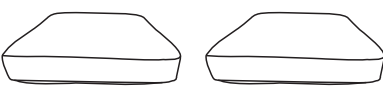
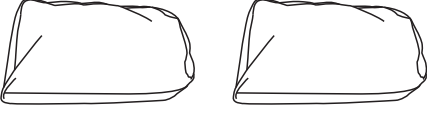
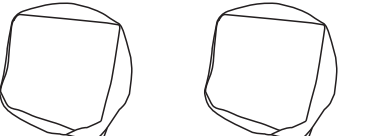
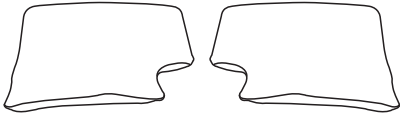
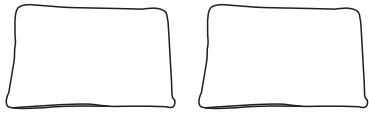
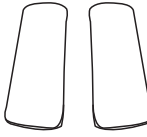
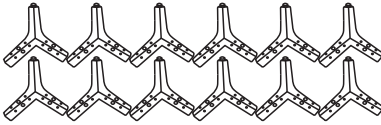
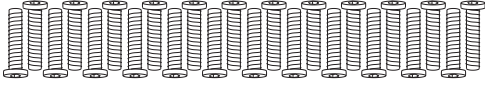
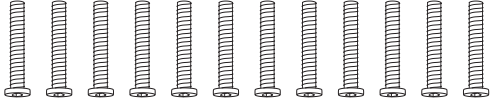
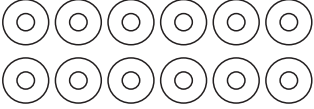

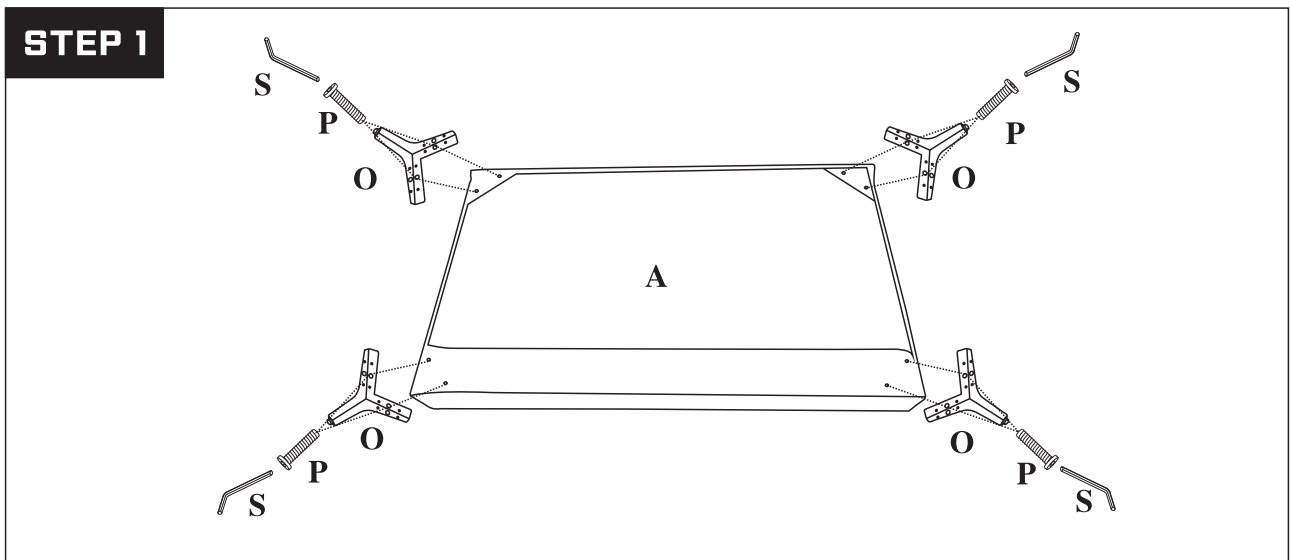
STEP 2

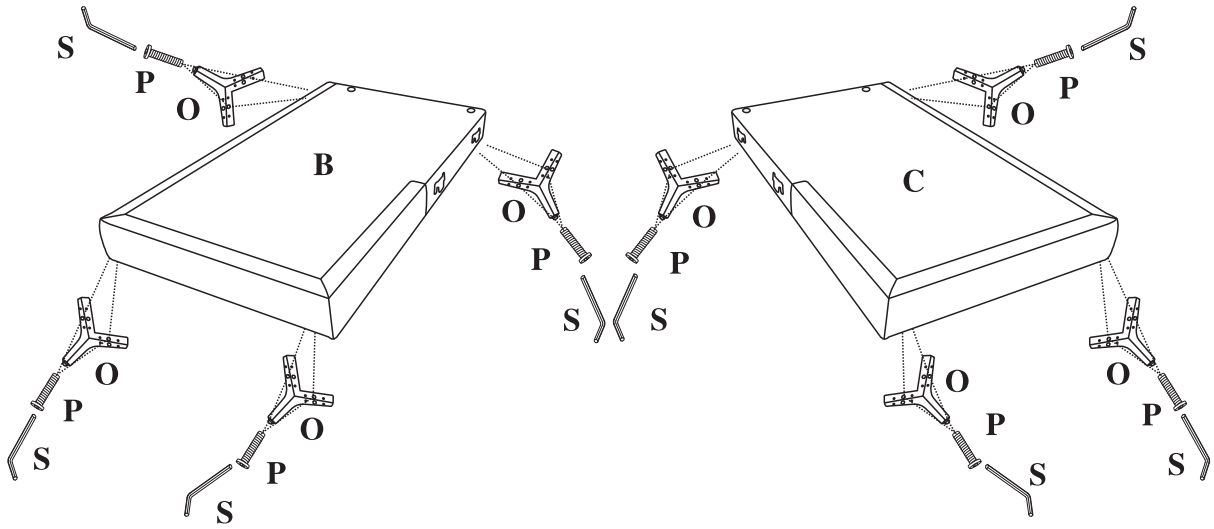

STEP 3

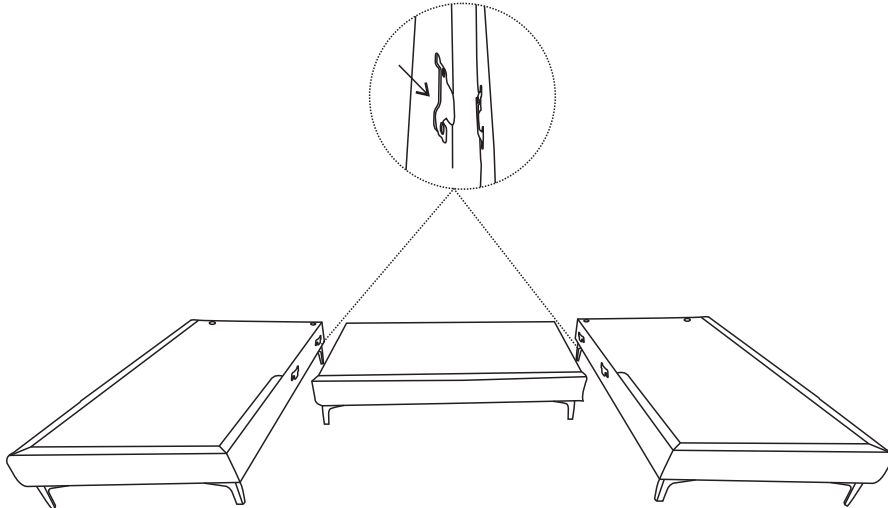

STEP 4

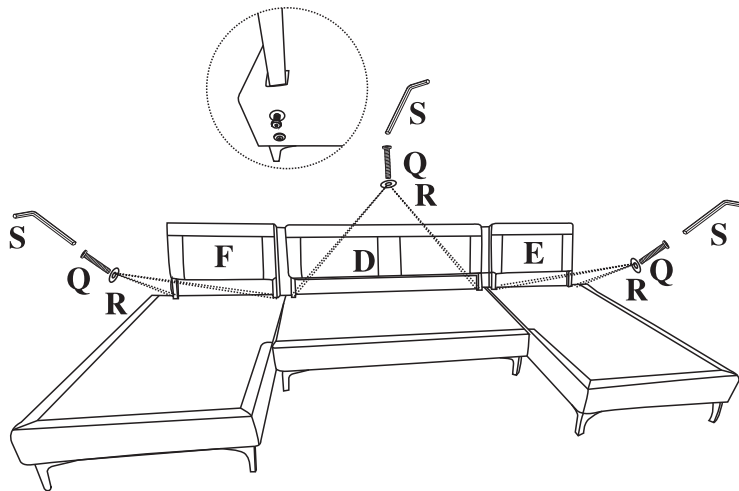

STEP 5

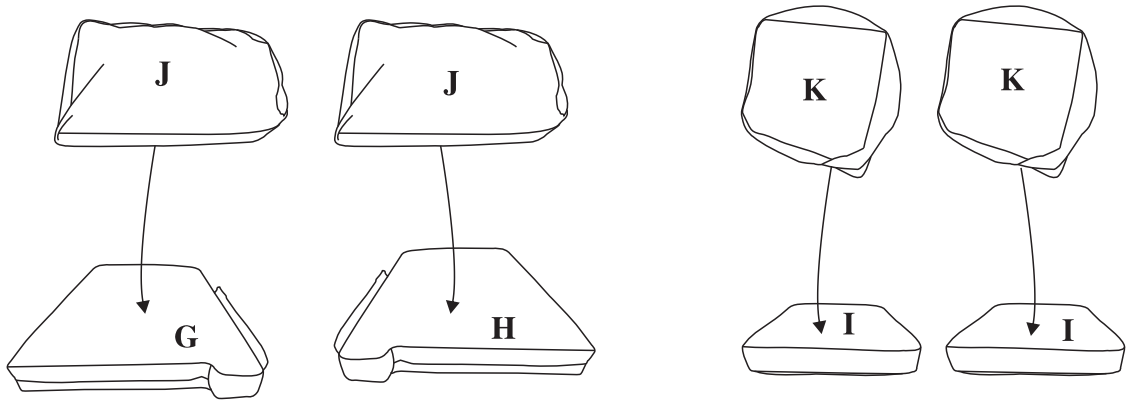

STEP 6

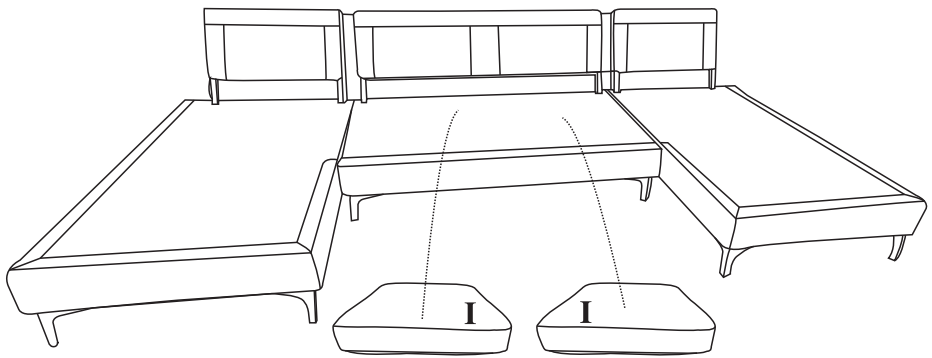

STEP 7

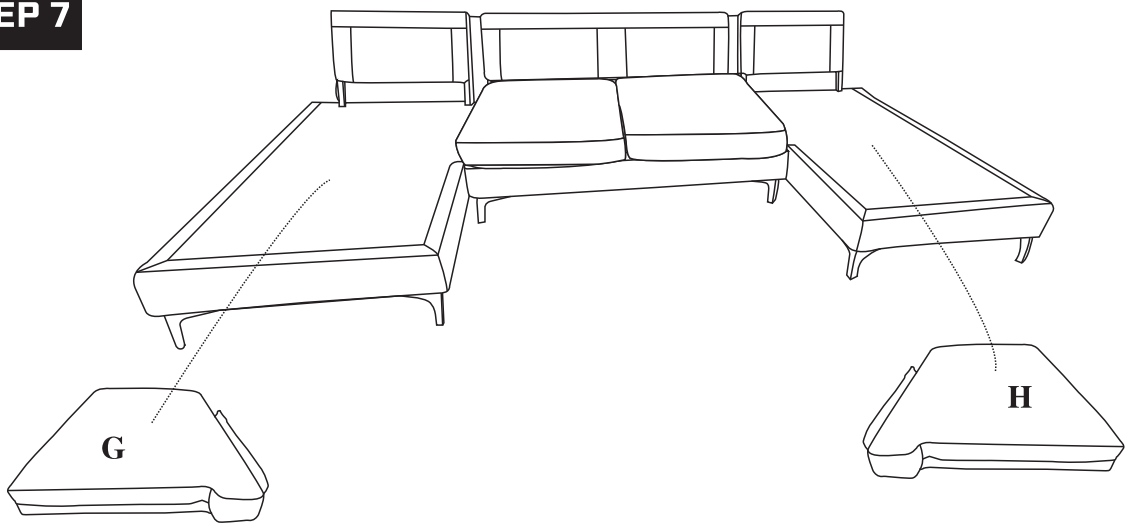

STEP 8

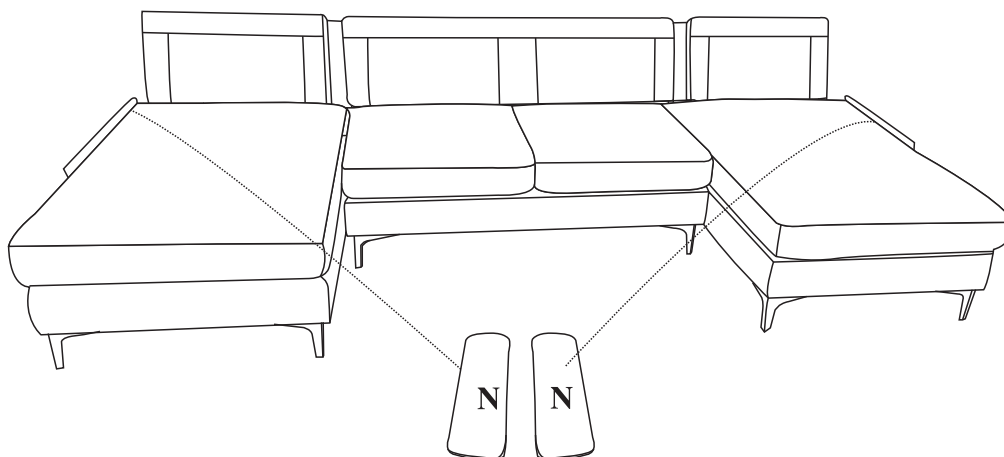

STEP 9

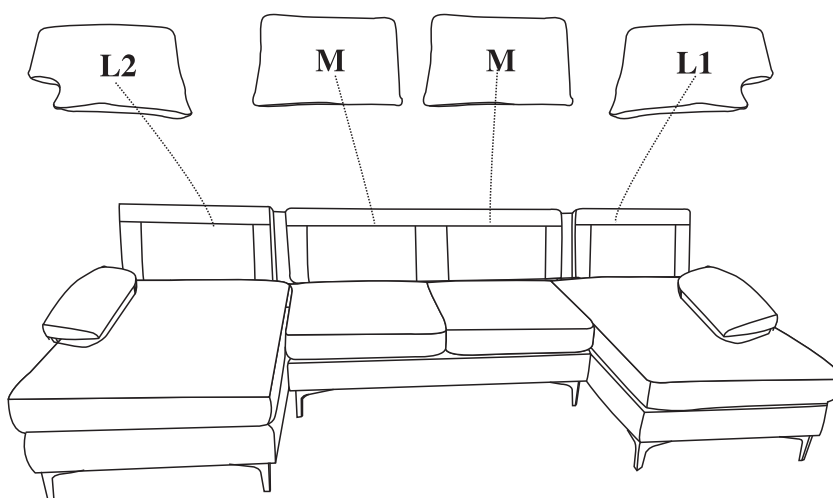

STEP 10

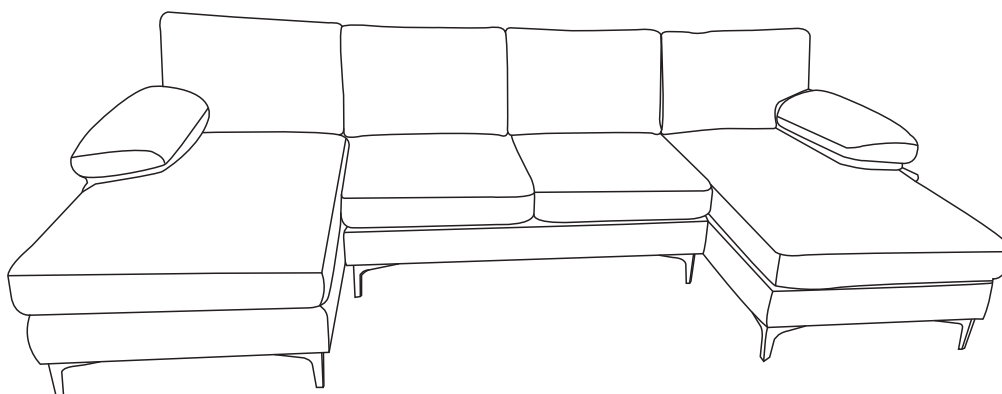

ATTENTION:

1. Please check the manual carefully and make sure you have received all the parts.
2. If there is any missing, please let us know the letter of the parts you need.
3. If there is any damage, please send clear photos to us, we will check and offer you best solution soon.