

Wooden Picnic Table Assembly Instruction

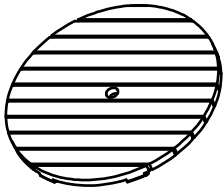

A 1pc

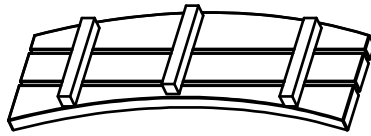

B 3pcs

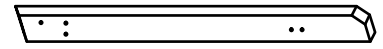

C 2pcs

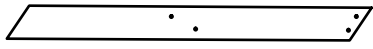

D 3pcs

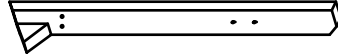

E 1pc

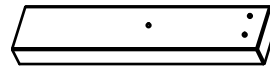

F 6pcs

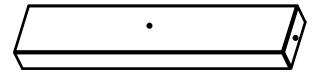

G 3pcs



H 8x60mm 12pcs

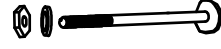

I 6x60mm 18pcs

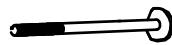

J 6x40mm 6pcs

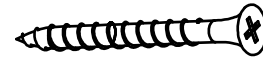

K 3.5x50mm 6pcs

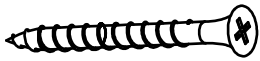

L 3.5x40mm 5pcs



M M8 12pcs

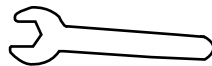

O 10# 1pc



P 14# 1pc

Step 1

I 6pcs

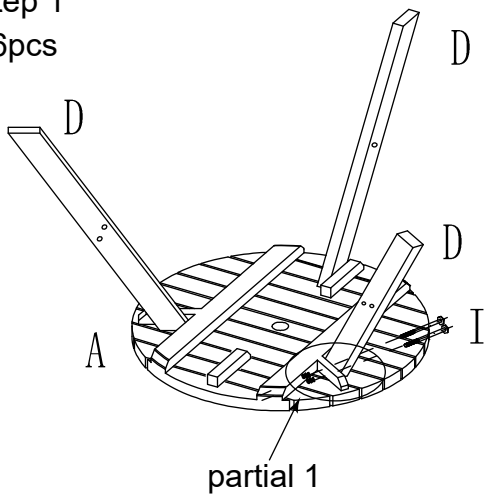

partial 1

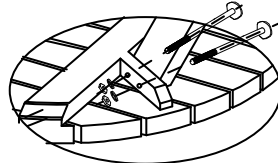

Each leg D on the right of wood piece just like above photo bolts I 50% tighten

Step 2

K 6pcs

L 2pcs

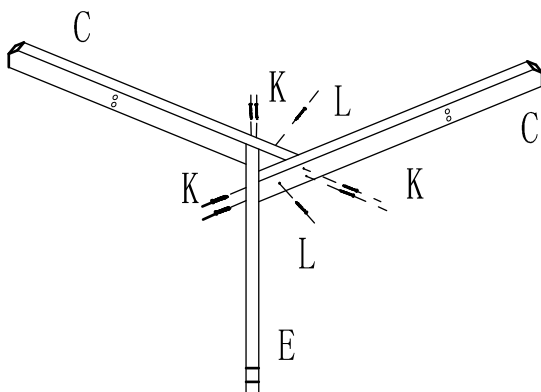

Each leg assembled just like above photo

K and L should be 100% tighten

Step 3
 H 6pcs
 M 12pcs

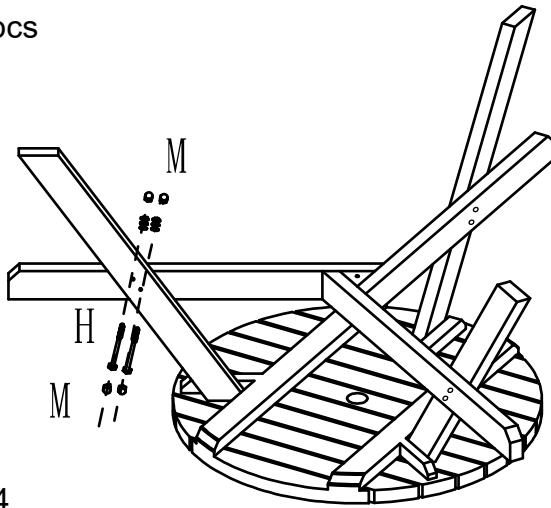

All of the drag wood are on the right side of the leg D
 H should be 100% tighten
 After H be tightened, then put on M

Step 4
 I 12pcs

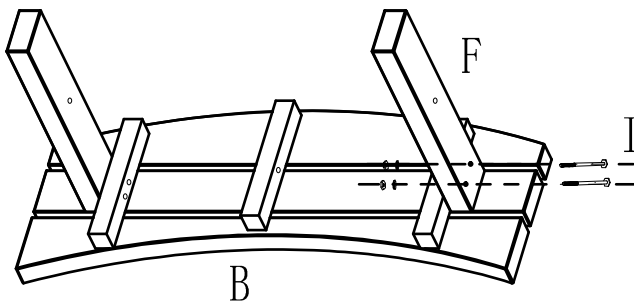

I should be tighten by 50%
 Repeat this step on the other two benches

Step 5
 J 6pcs

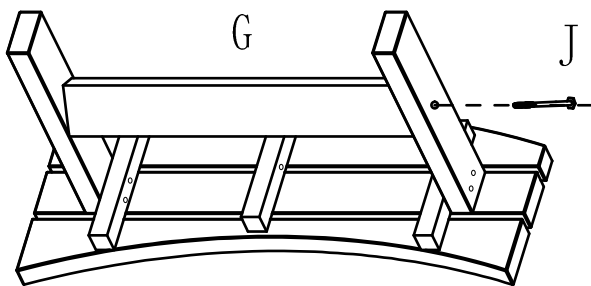

J should be tighten by 30%
 Repeat this step on the other two benches

Step 6
 H 6pcs
 L 3pcs

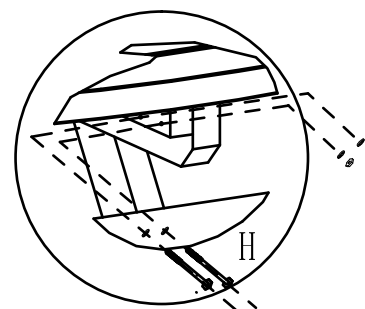
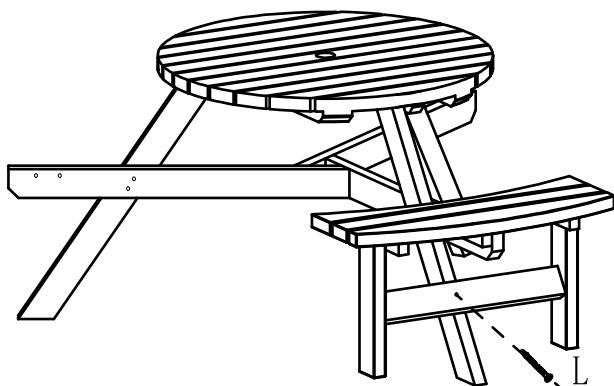

The cross wood in the middle of part B should be on the left side of C and be vertical with D then assemble Bolts H, until it is 100% tighten then assemble L until 100% tighten
 Repeat this step on the other two benches

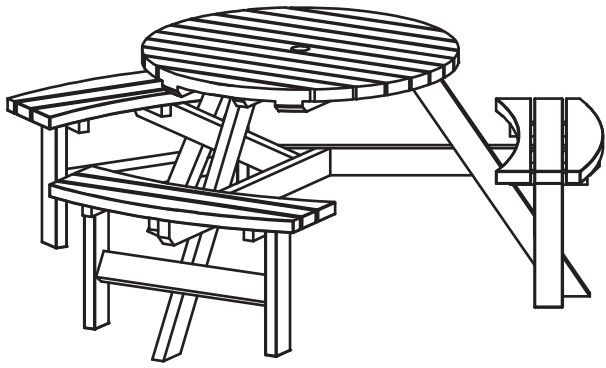

repeat last step until assemble complete
then tighen every bolts and screws to be 100%

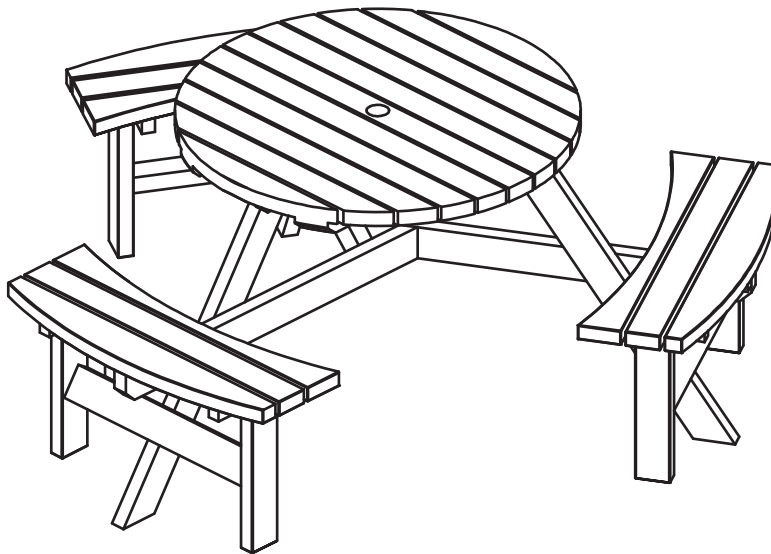

Complete

Max capacity
Table top:75LBS
Each seat:500LBS