

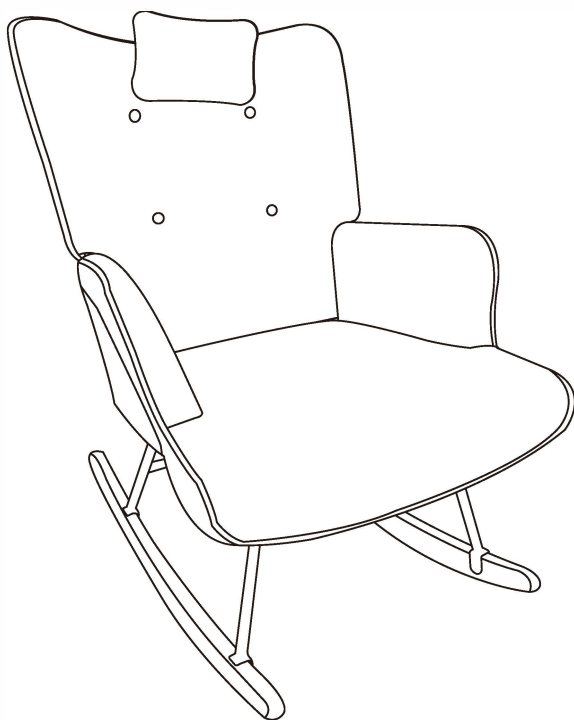

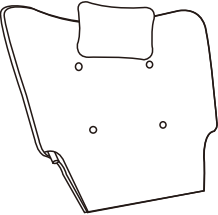

W1372S00009

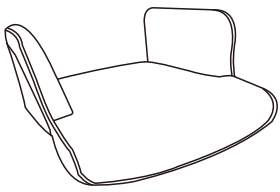
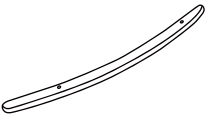
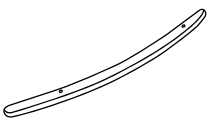
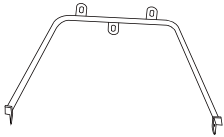
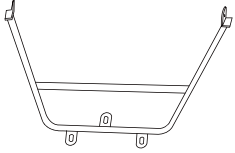

<p>A</p>  <p>x 1</p>	<p>B</p>  <p>x 1</p>	<p>C</p>  <p>x 1</p>
<p>D</p>  <p>x 1</p>	<p>E</p>  <p>x 1</p>	<p>F</p>  <p>x 1</p>
<p>G</p>  <p>x 2</p>	<p>H</p>  <p>x 10</p>	<p>I</p>  <p>x 2</p>
<p>J</p>  <p>x 1</p>		

Attention :

1.screws should be only 50% tight.

2.after all the screws adjust the holes then tight screws 100% totally.

1

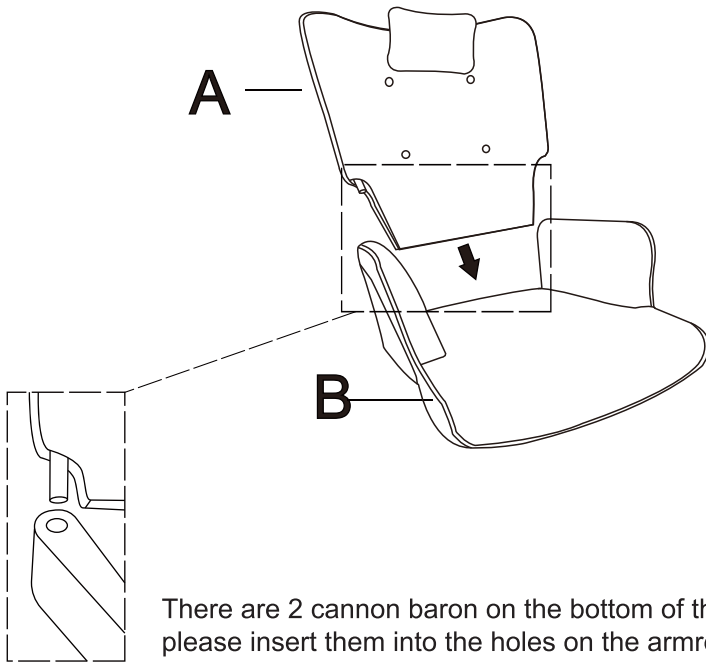

Attention :

1.screws should be only 50% tight.

2.after all the screws adjust the holes then tight screws 100% totally.

2

Hold the backrest
and press down

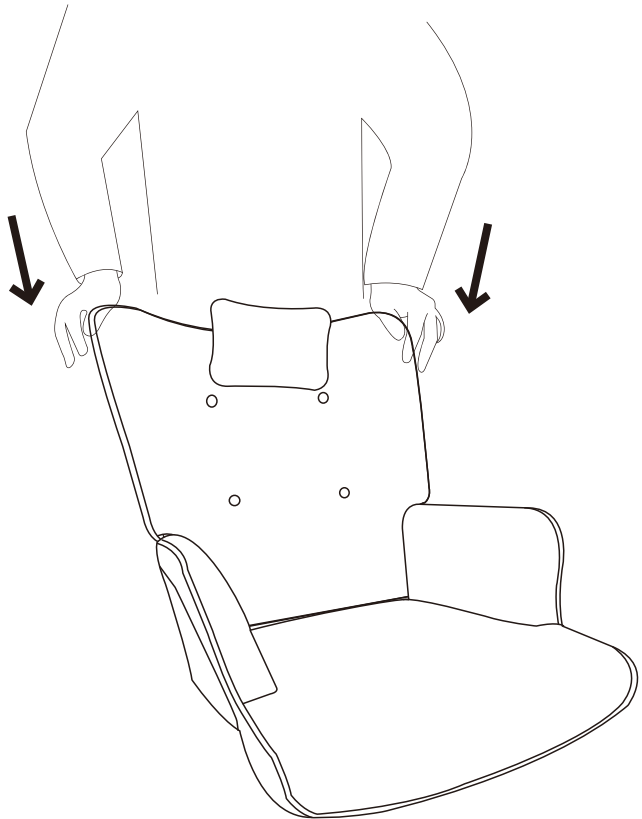

Attention :

1.screws should be only 50% tight.

2.after all the screws adjust the holes then tight screws 100% totally.

3

Make sure the back and the bottom tight fit, then draw the screws in, then tighten.

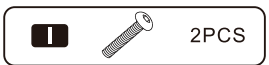
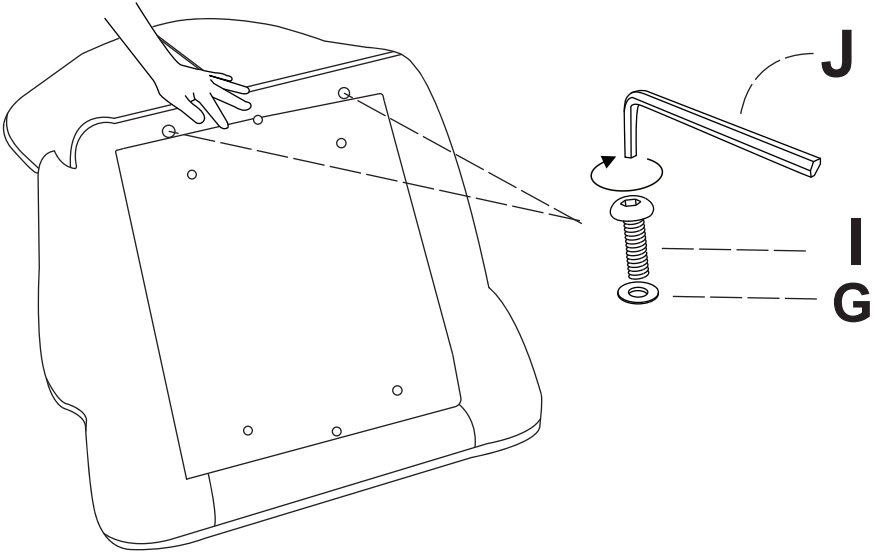

Attention :

1.screws should be only 50% tight.

2.after all the screws adjust the holes then tight screws 100% totally.

4

Pay attention the E has a cross bar compare to F.

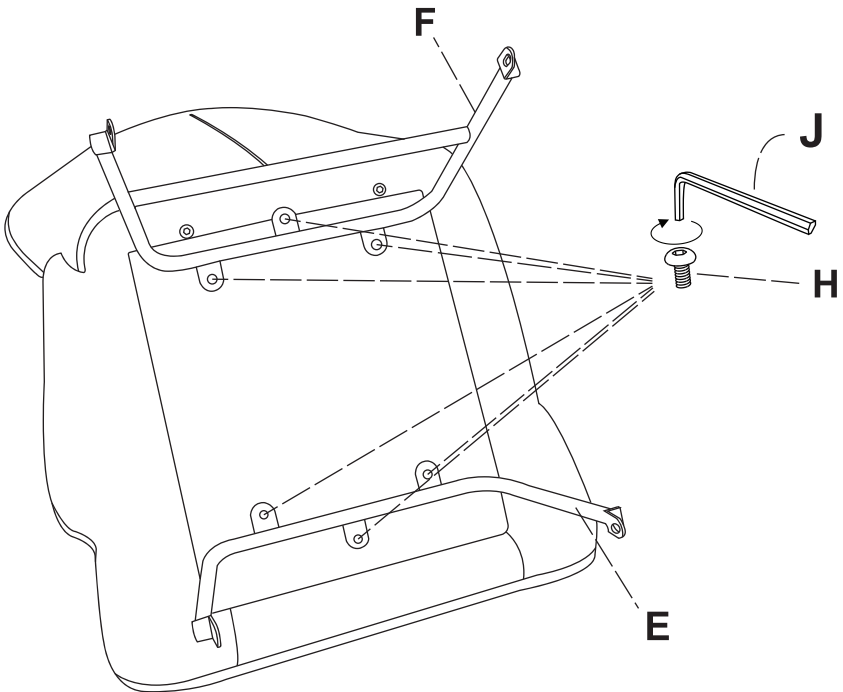

H



6PCS

Attention :

- 1.screws should be only 50% tight.
- 2.after all the screws adjust the holes then tight screws 100% totally.

5

Make sure the longer side of C and D is facing the back of the chair.

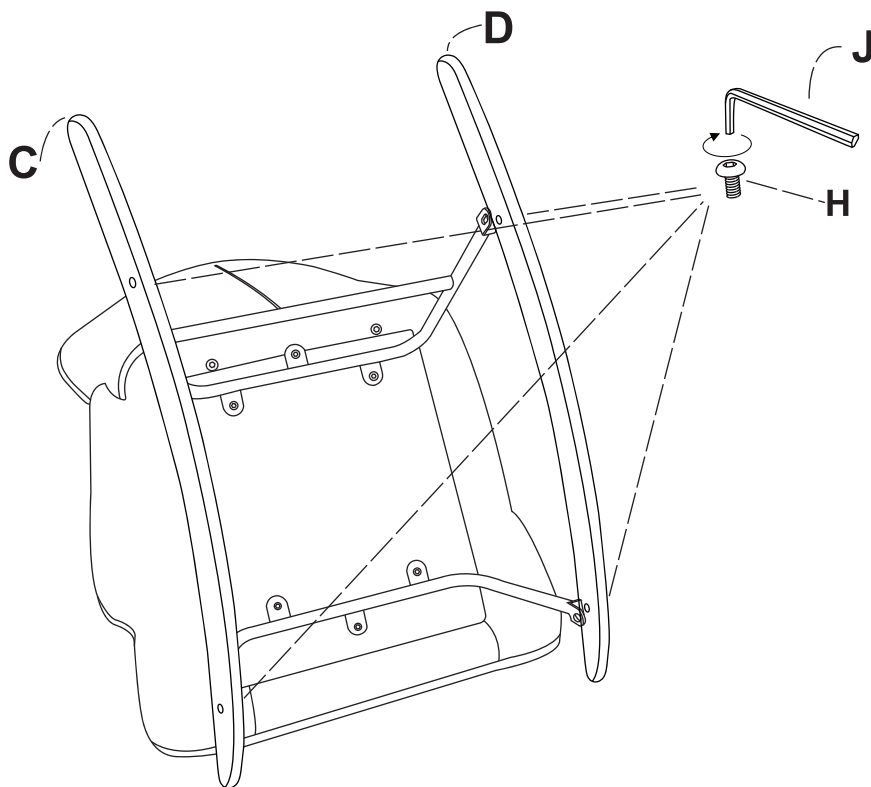

H



4PCS

Ax1

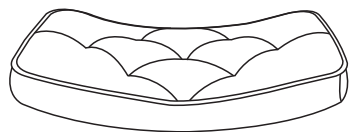

Bx4

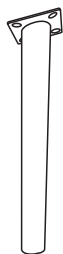

Cx16

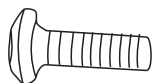

Dx1

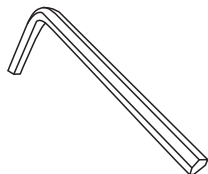

①

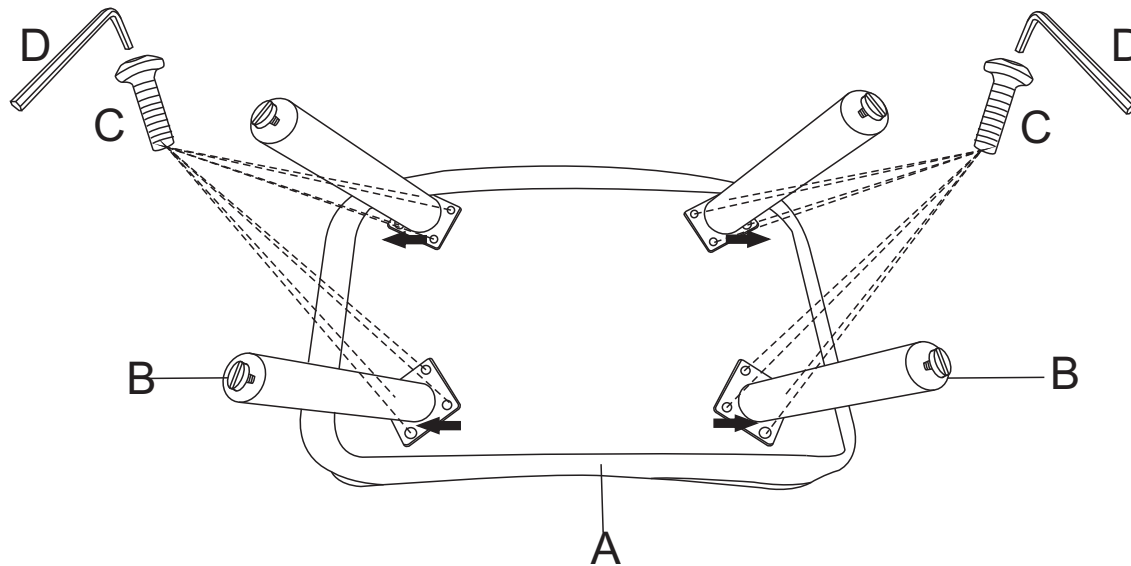

②

