

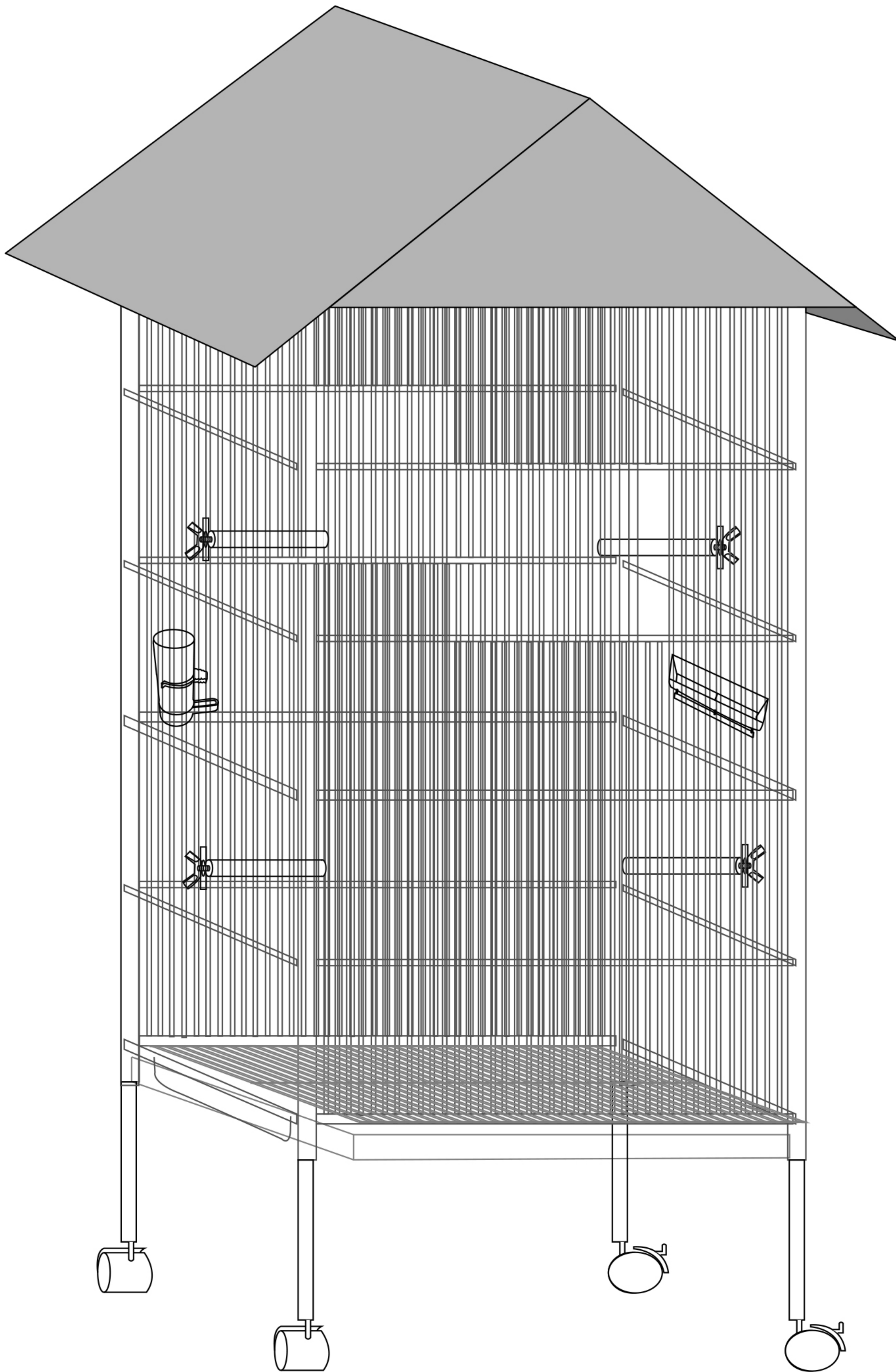

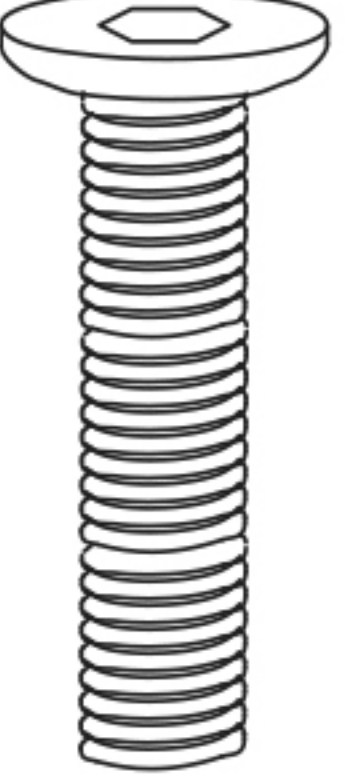

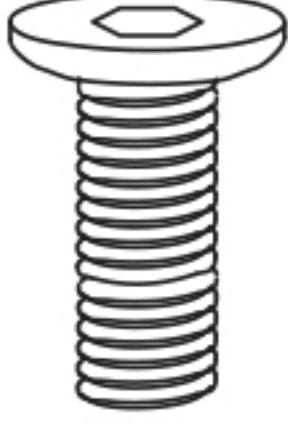





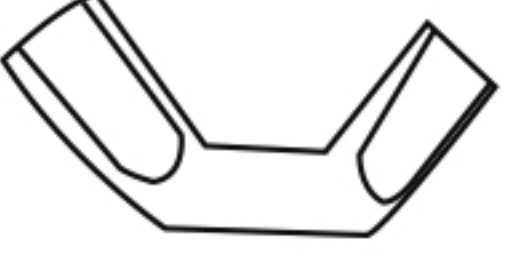

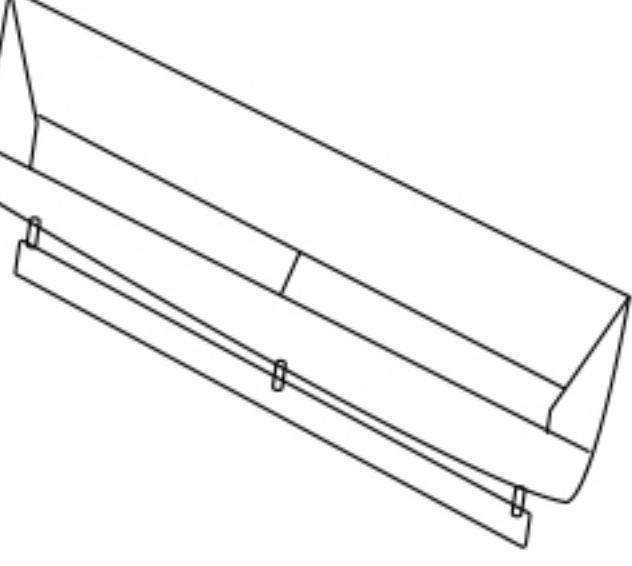
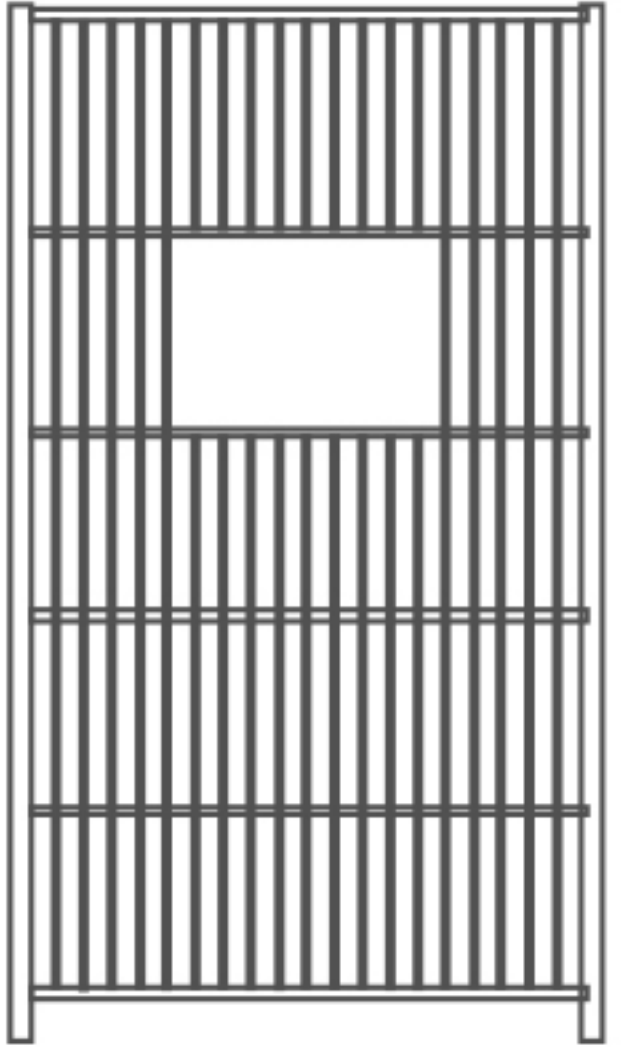
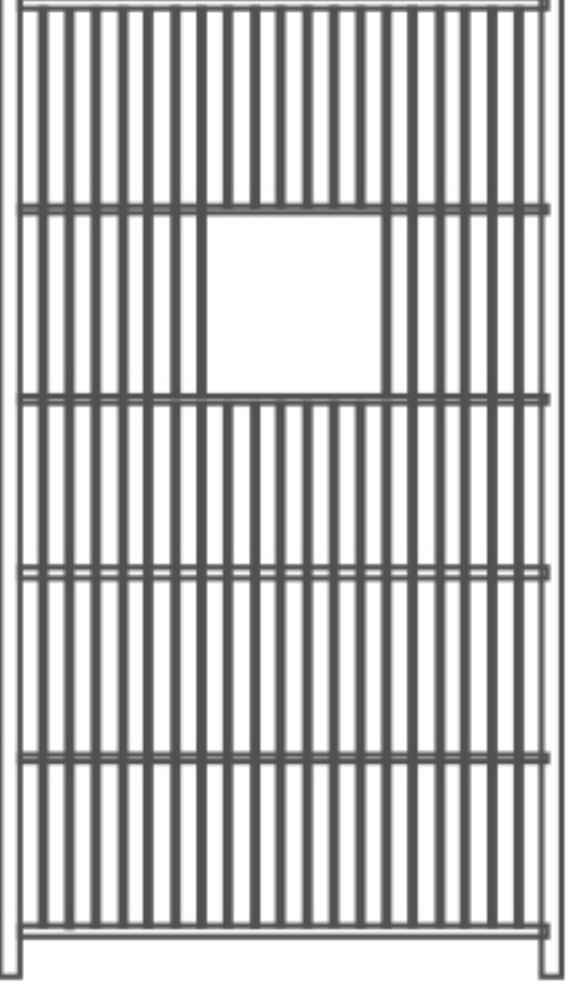

INSTRUCTION MANUAL

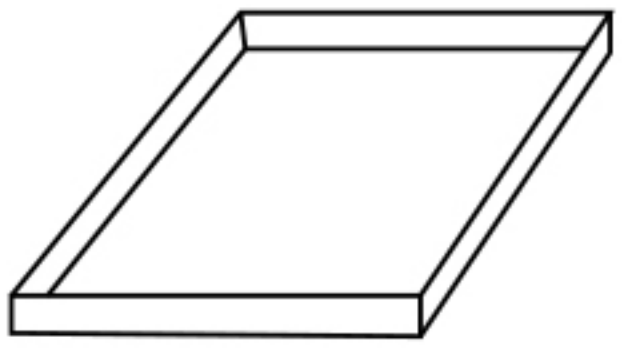
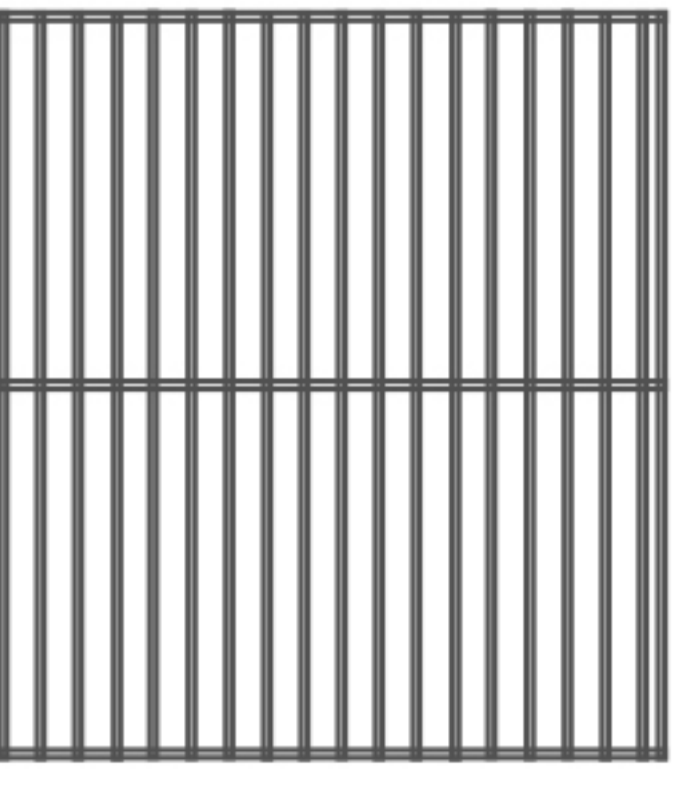
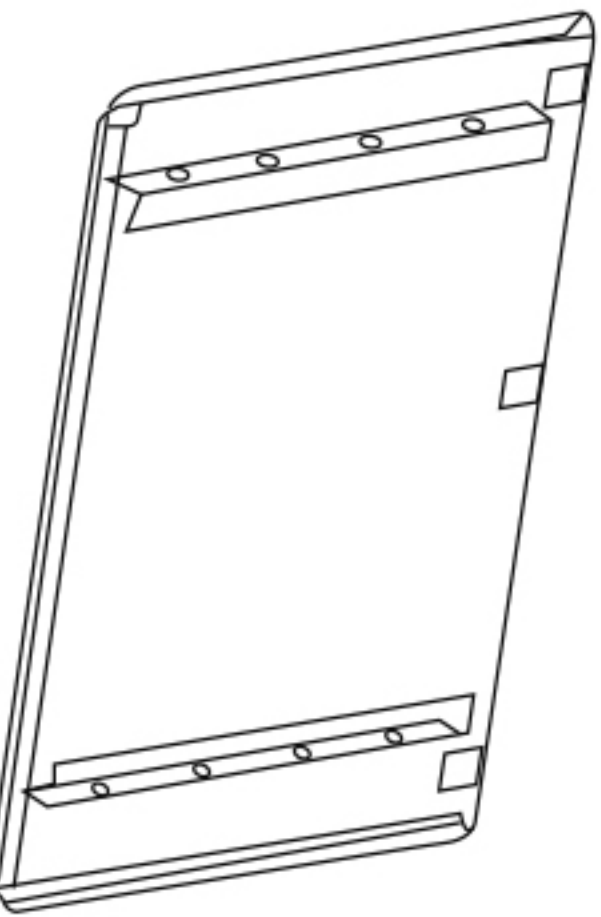
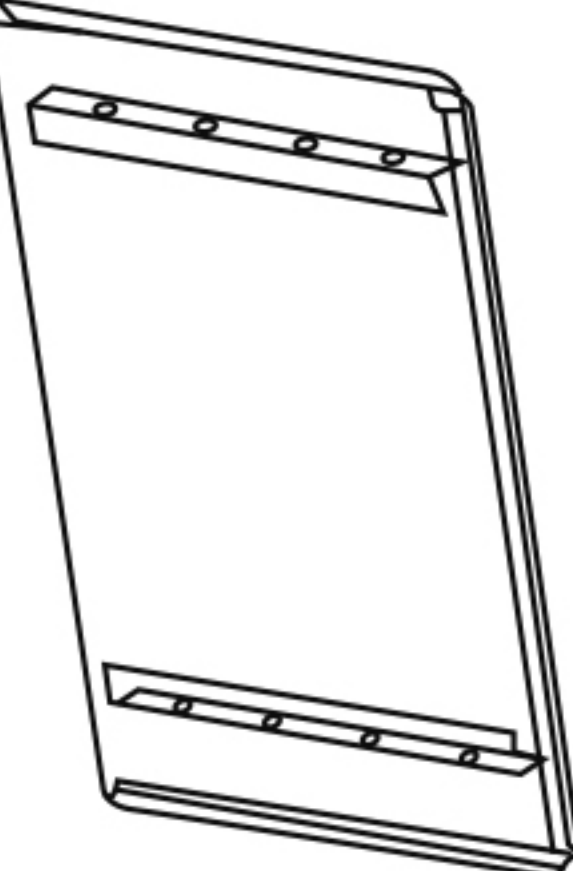
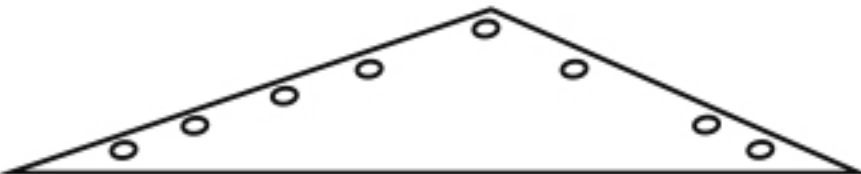

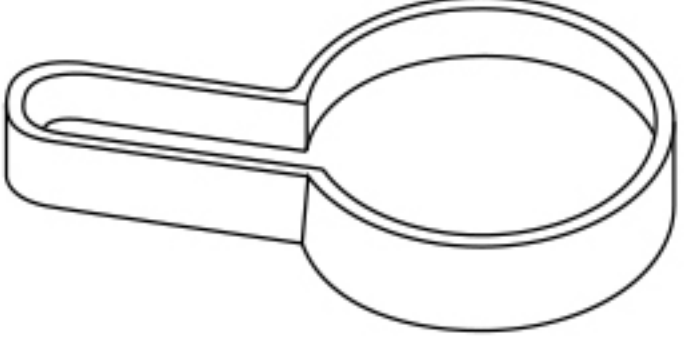
RETAIN FOR FUTURE REFERENCE

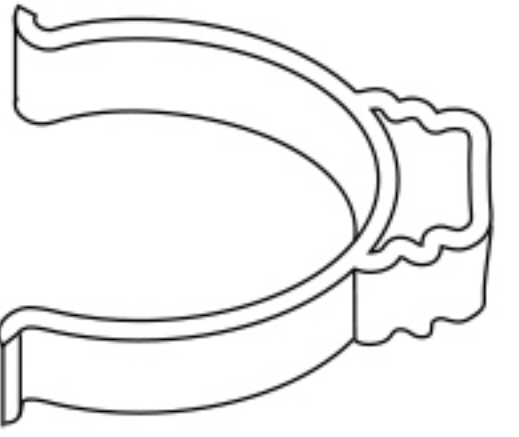
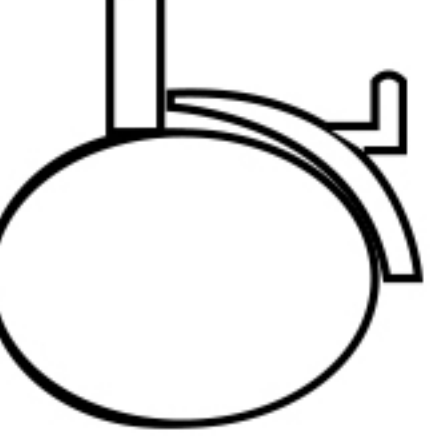
PARTS LIST

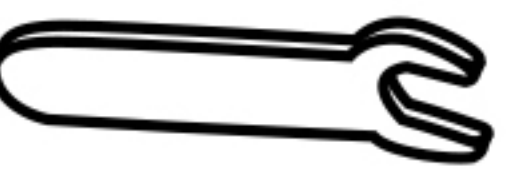
<p>A</p>  <p>M6*30 12pcs</p>	<p>B</p>  <p>M5*10 16pcs</p>	<p>C</p>  <p>M5 16pcs</p>	<p>D</p>  <p> 4pcs</p>
<p>E</p>  <p> 8pcs</p>	<p>F</p>  <p> 4pcs</p>	<p>G</p>  <p> 4pcs</p>	<p>H</p>  <p> 1pc</p>
<p>I</p>  <p> 1pc</p>	<p>J</p>  <p> 1pc</p>	<p>K</p>  <p> 2pcs</p>	<p>L</p>  <p> 1pc</p>
<p>M</p>  <p> 1pc</p>	<p>N</p>  <p> 1pc</p>	<p>O</p>  <p> 1pc</p>	<p>P</p>  <p> 2pcs</p>
<p>Q1</p>  <p> 1pc</p>	<p>Q2</p>  <p> 1pc</p>	<p>S</p>  <p>S3 1pc</p>	<p>U</p>  <p>8 1pc</p>
<p>Q3</p>  <p> 1pc</p>	<p>R</p>  <p> 4pcs</p>	<p>T</p>  <p>S4 1pc</p>	<p>V</p>  <p>12 1pc</p>

ASSEMBLY

1

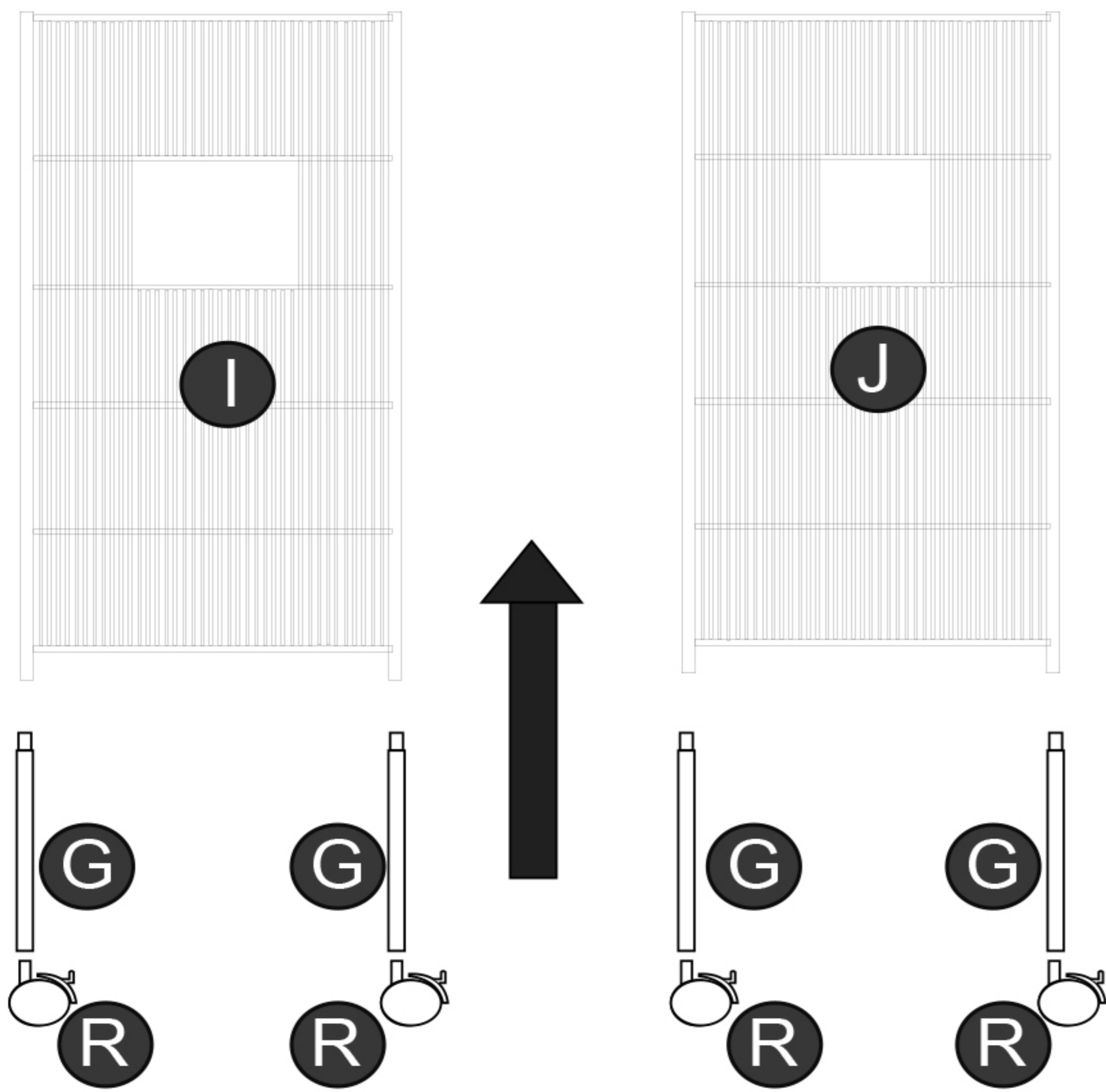

2

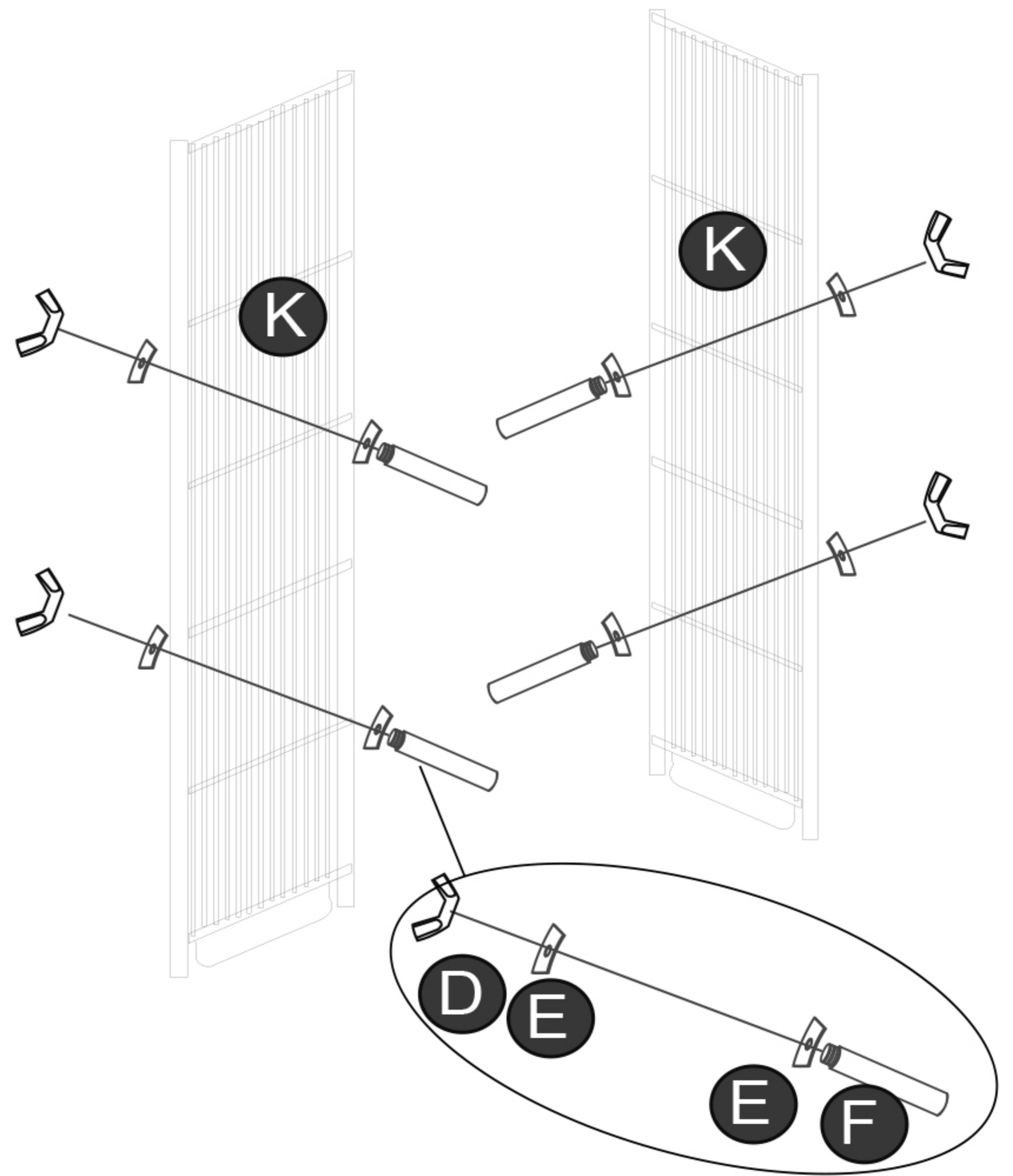

F: 4pcs
E: 8pcs
D: 4pcs

3

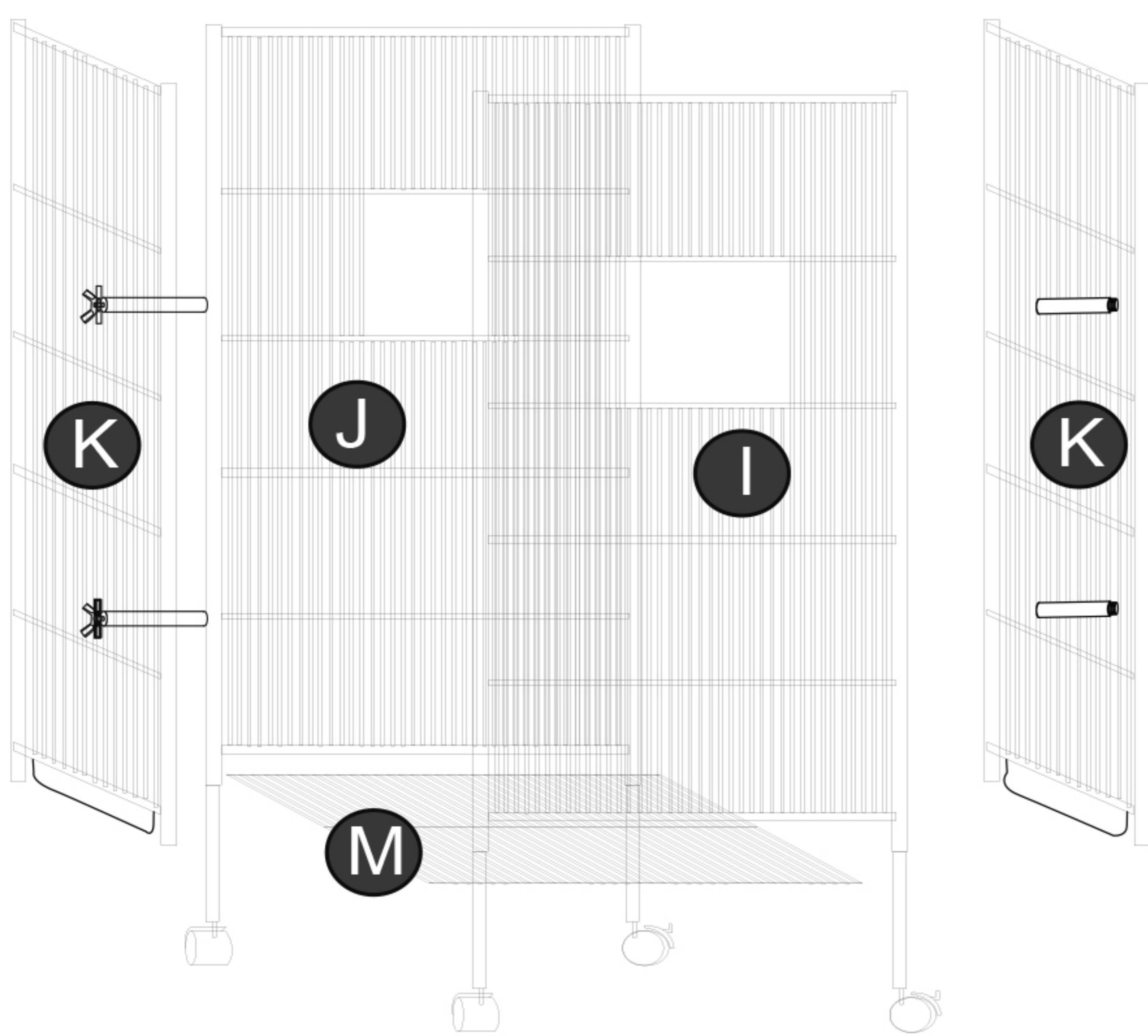

4

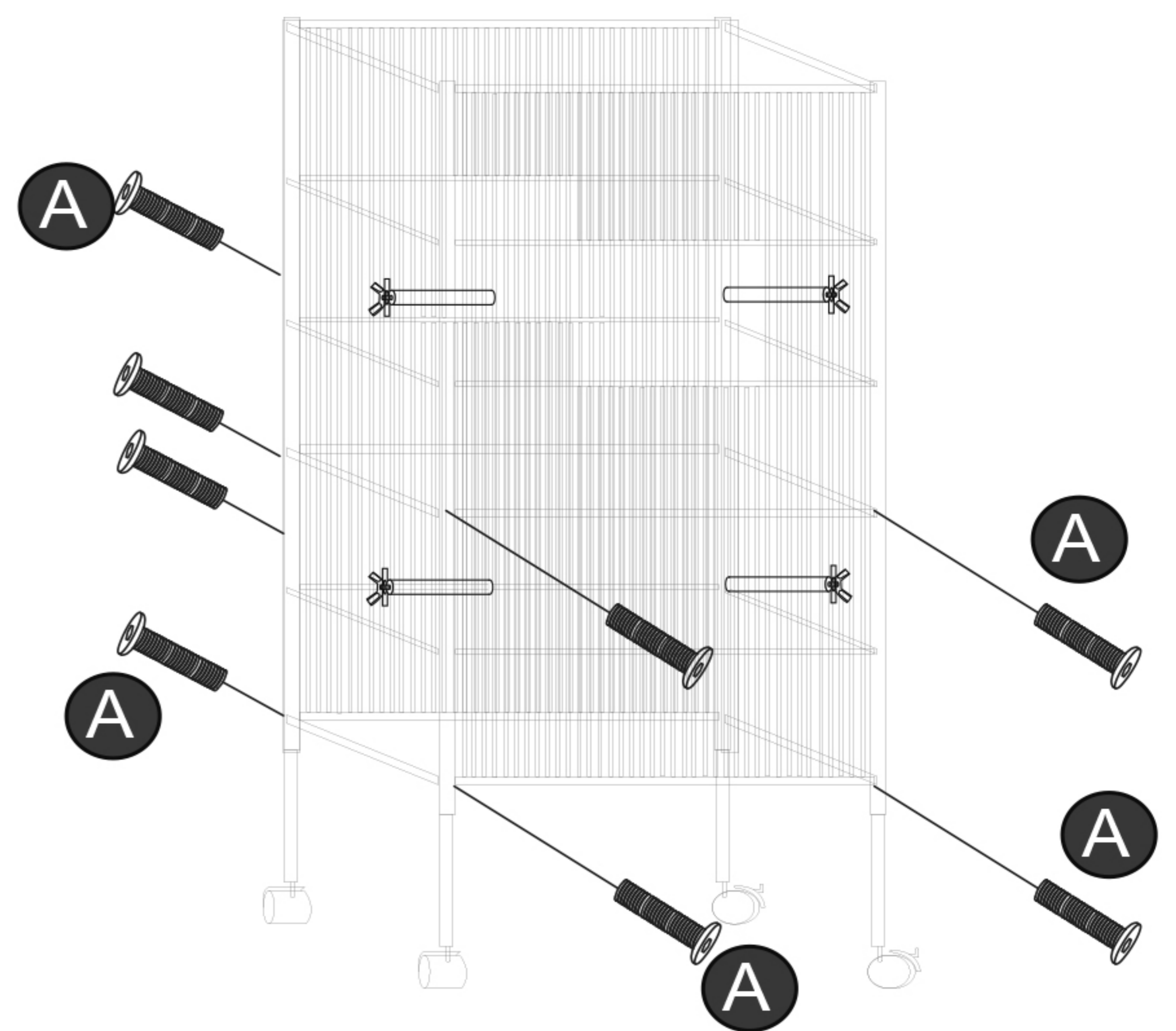

A: 8pcs

5

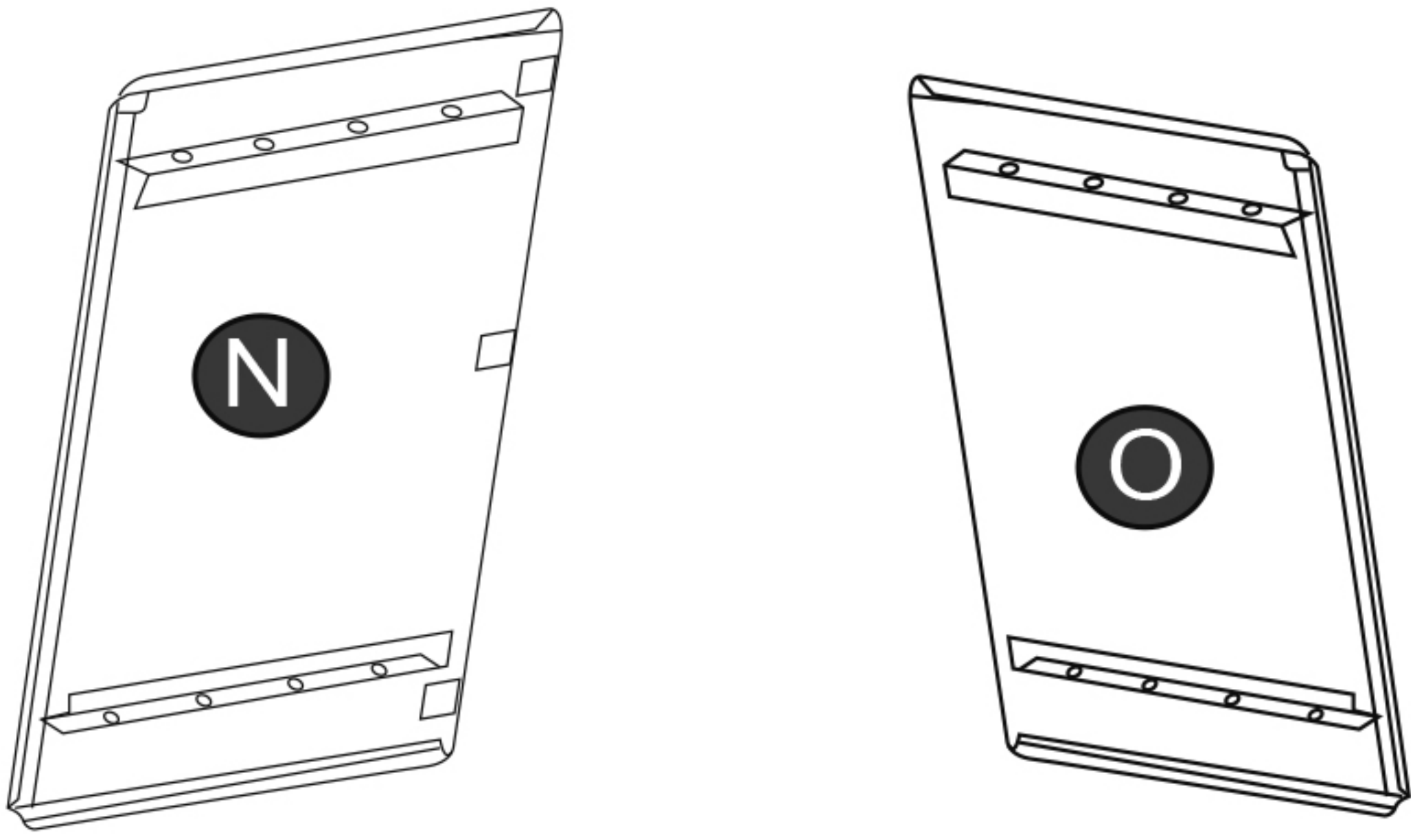

6

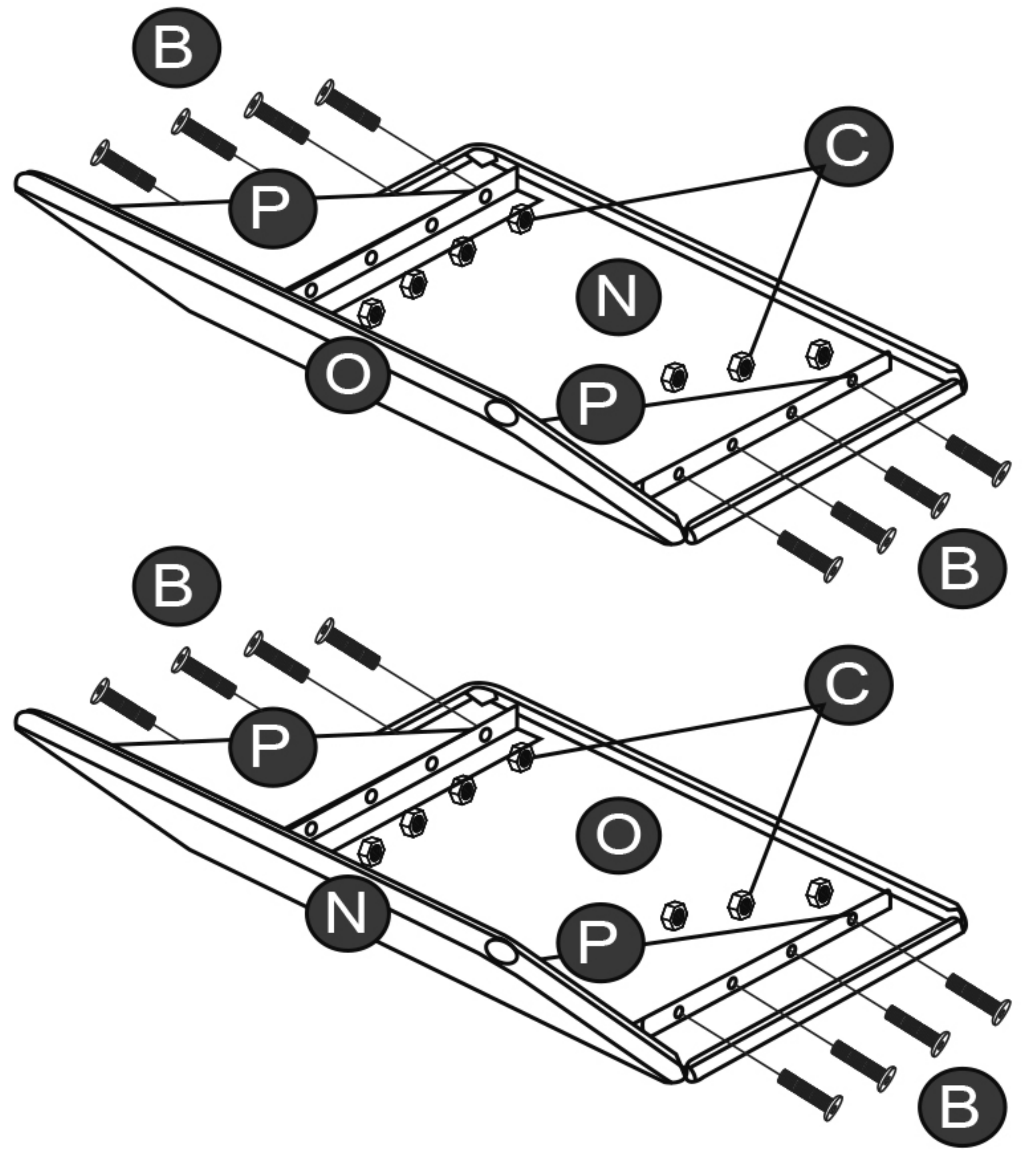

B: 16pcs
C: 16pcs

7

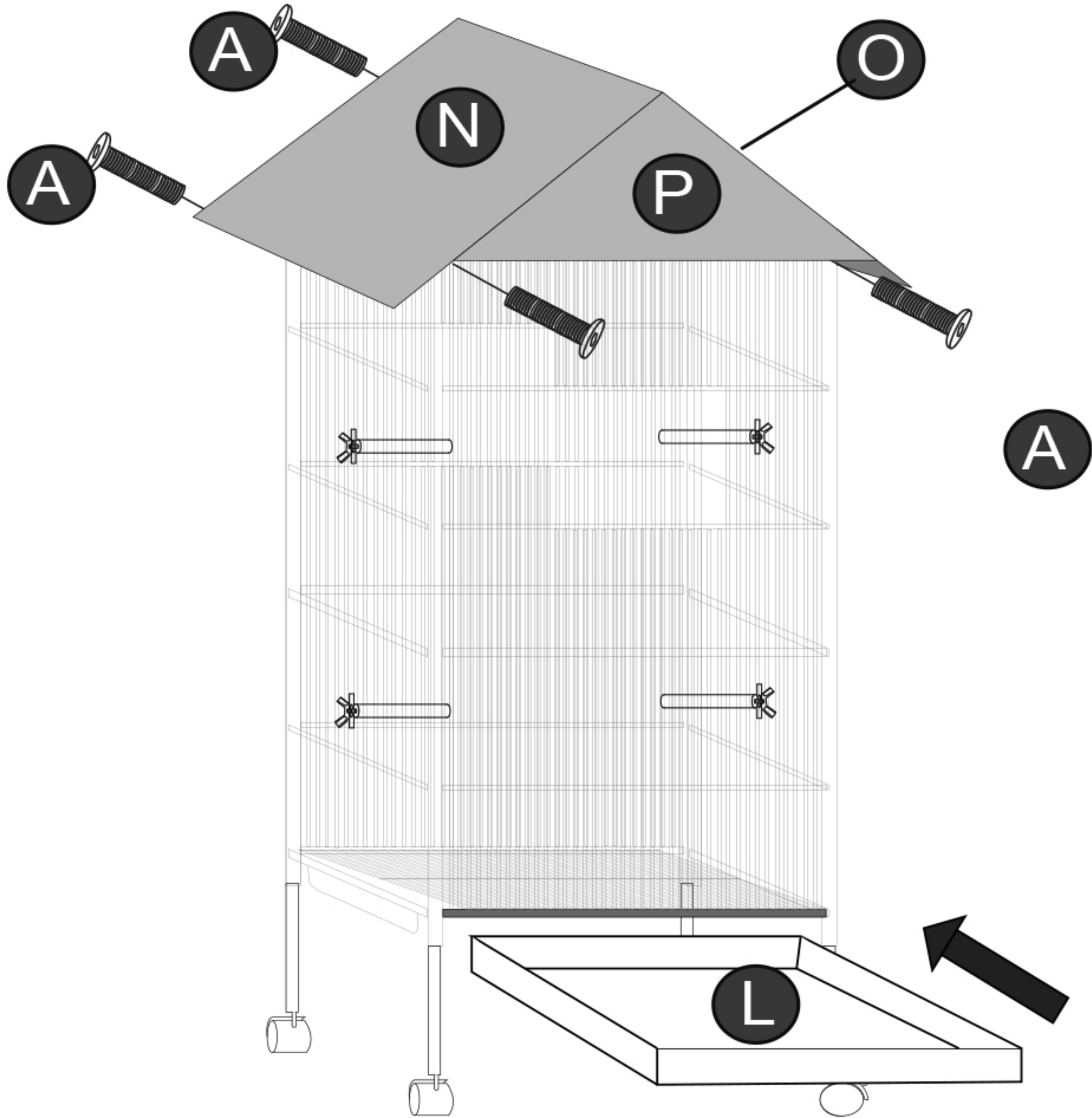

A: 4pcs

8

