

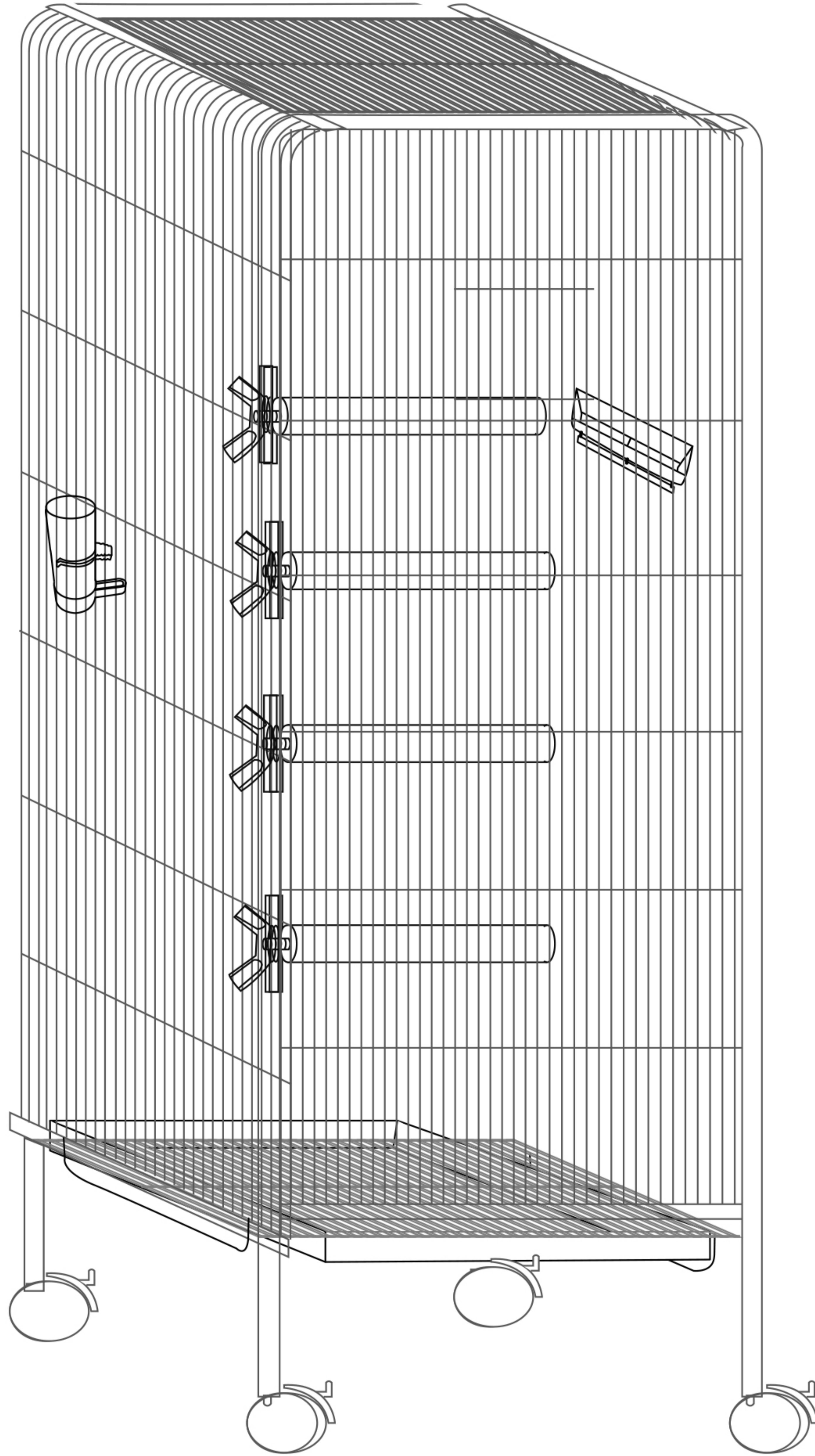

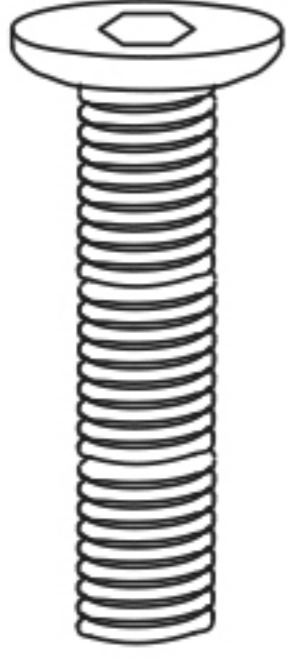



# INSTRUCTION MANUAL

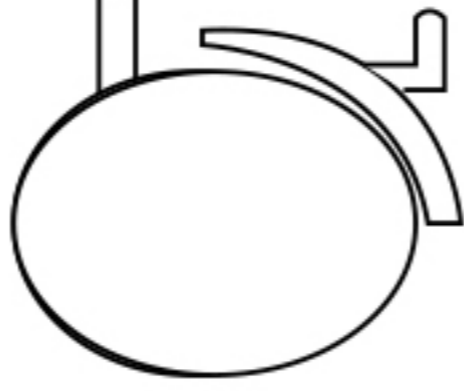
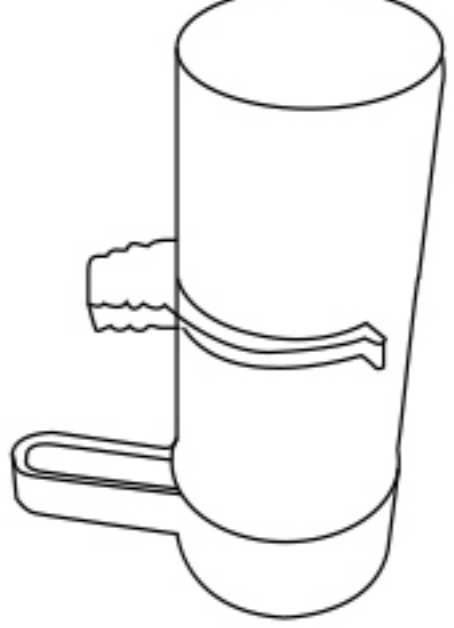
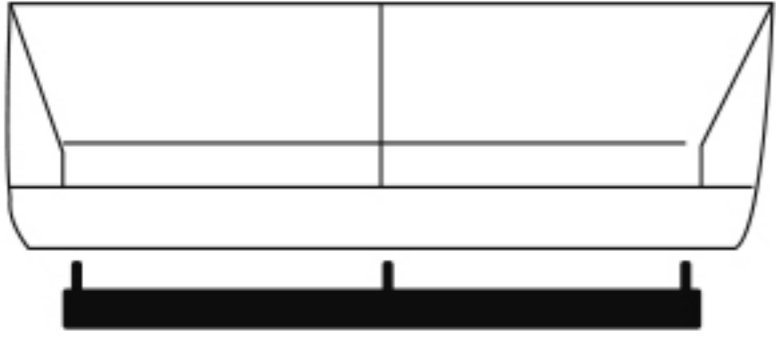
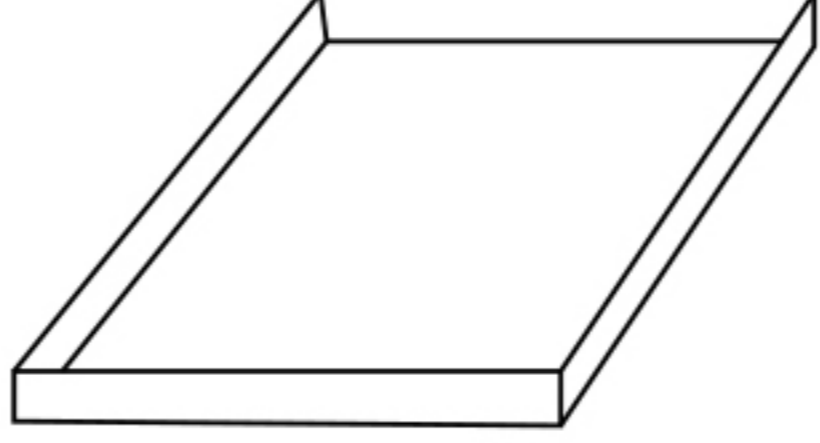
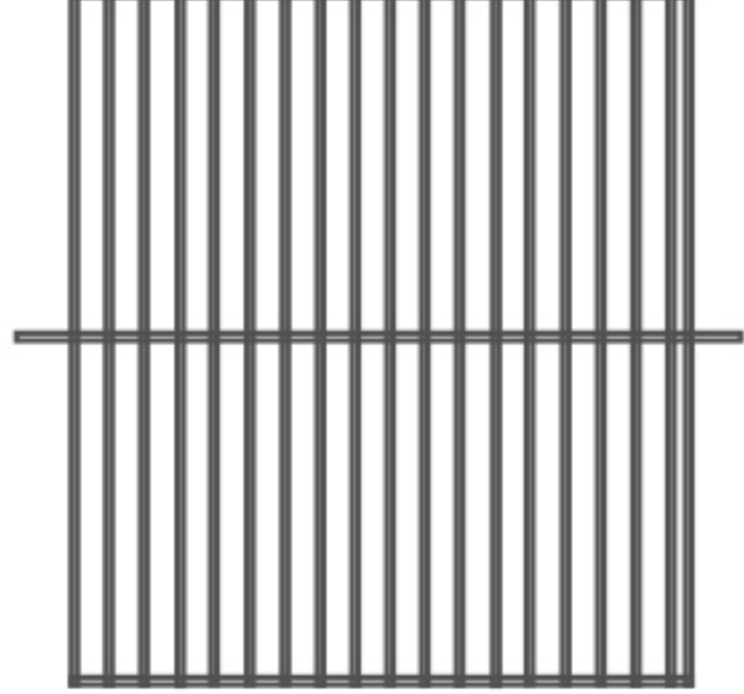
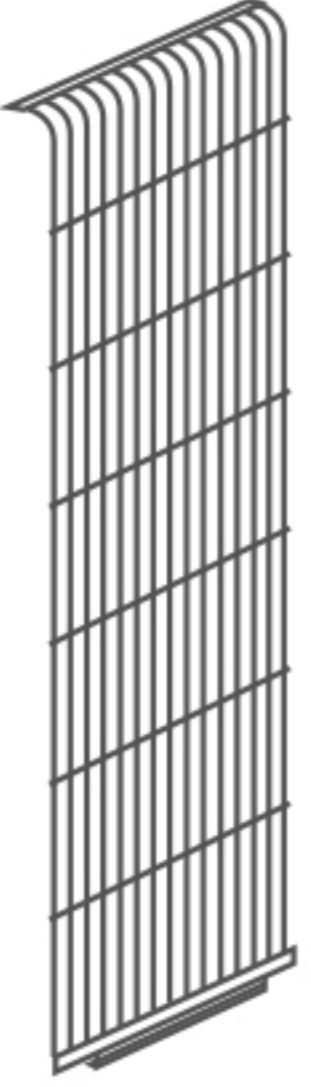
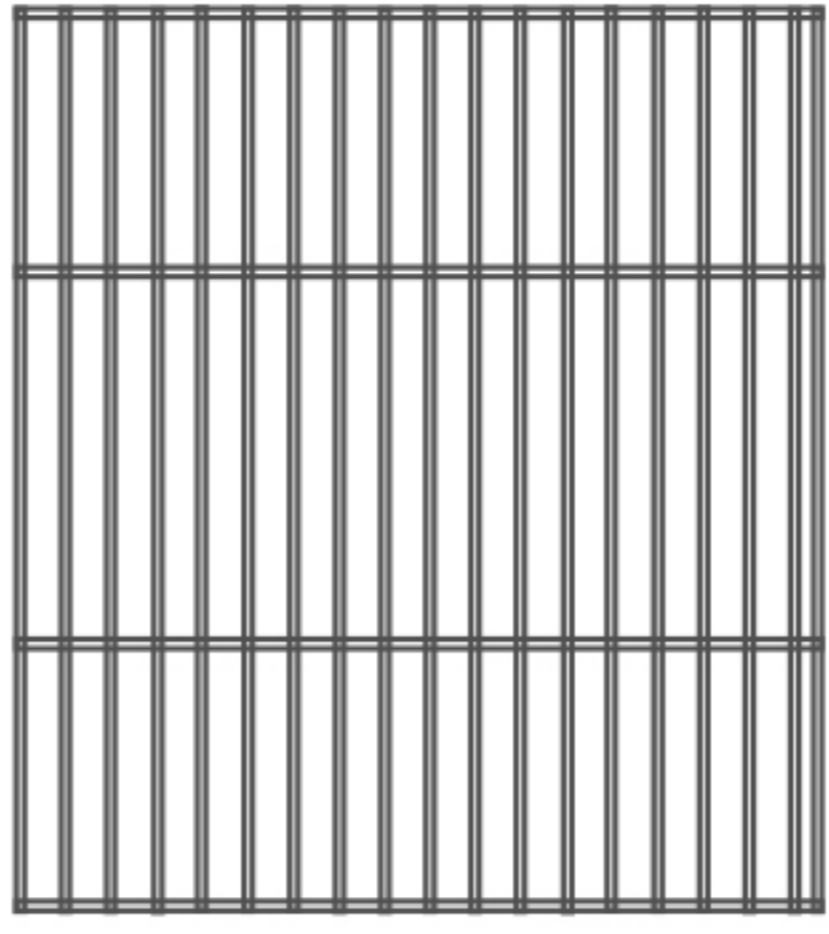
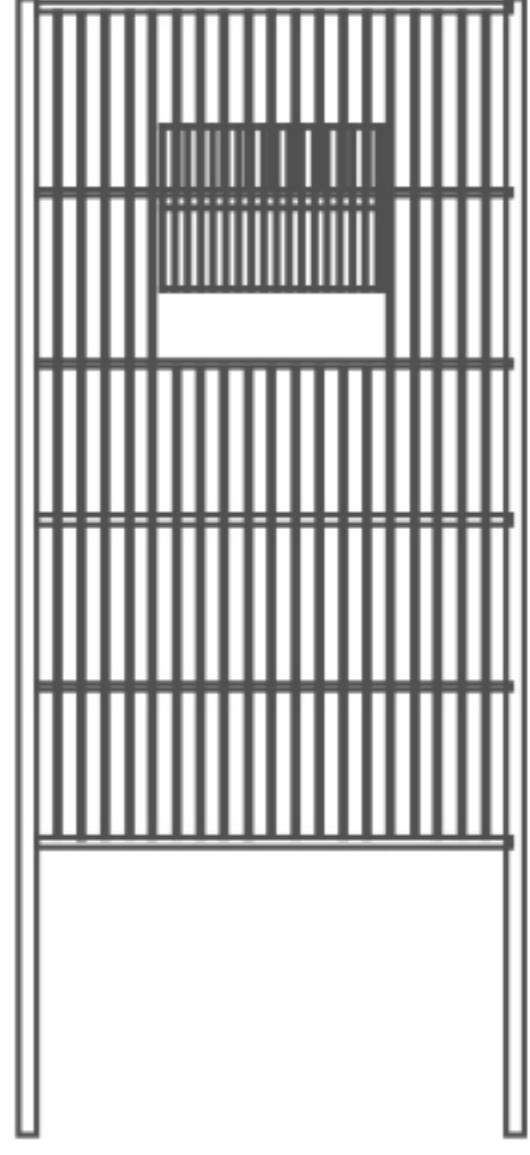
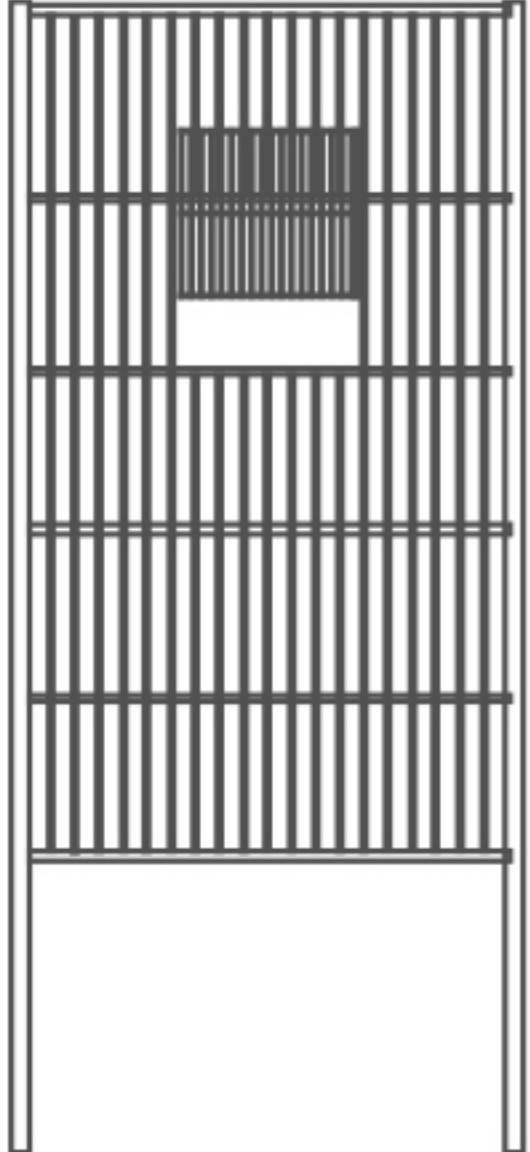

RETAIN FOR FUTURE REFERENCE

**PARTS LIST**

<p>A</p>  <p>M6*30</p> <p>12pcs</p>	<p>B1</p>  <p>4pcs</p>	<p>B2</p>  <p>4pcs</p>
<p>B3</p>  <p>8pcs</p>	<p>C</p>  <p>4pcs</p>	<p>D</p>  <p>1pc</p>
<p>E</p>  <p>1pc</p>	<p>F</p>  <p>1pc</p>	<p>G</p>  <p>1pc</p>
<p>H</p>  <p>2pcs</p>	<p>I</p>  <p>1pc</p>	<p>J</p>  <p>1pc</p>
<p>K</p>  <p>1pc</p>	<p>L</p>  <p>1pc</p>	<p>M</p>  <p>1pc</p>

# ASSEMBLY

①

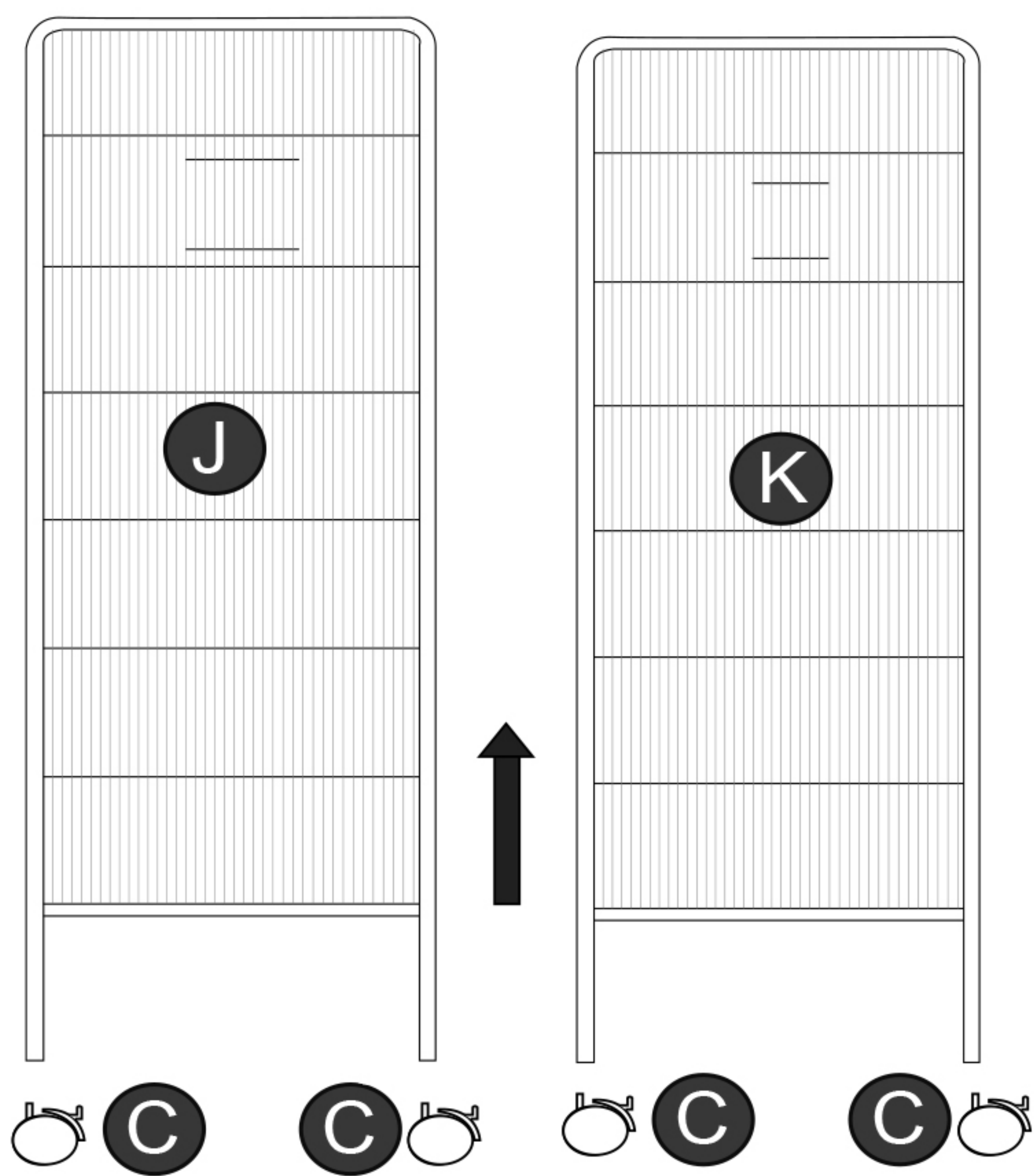

②

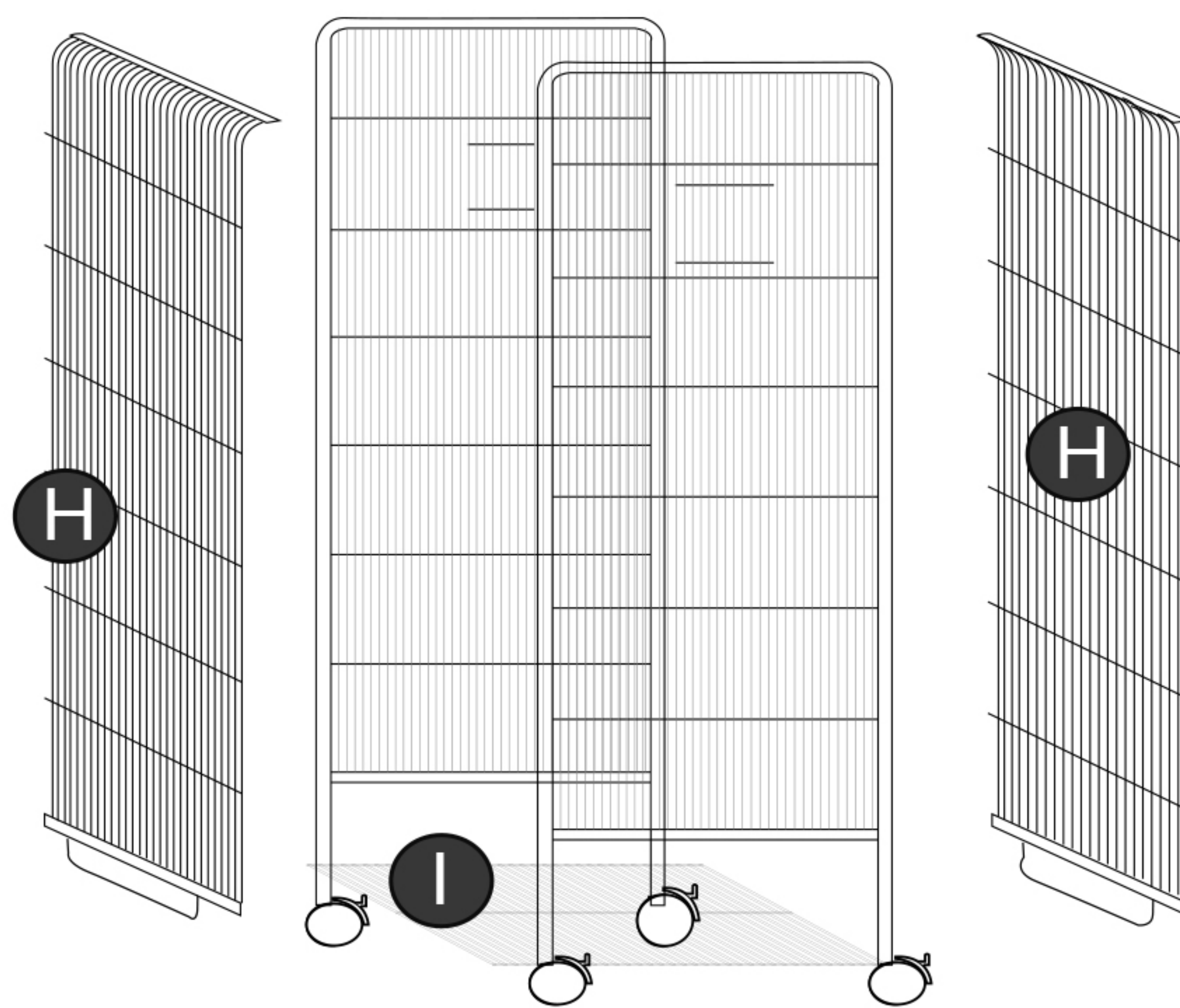

③

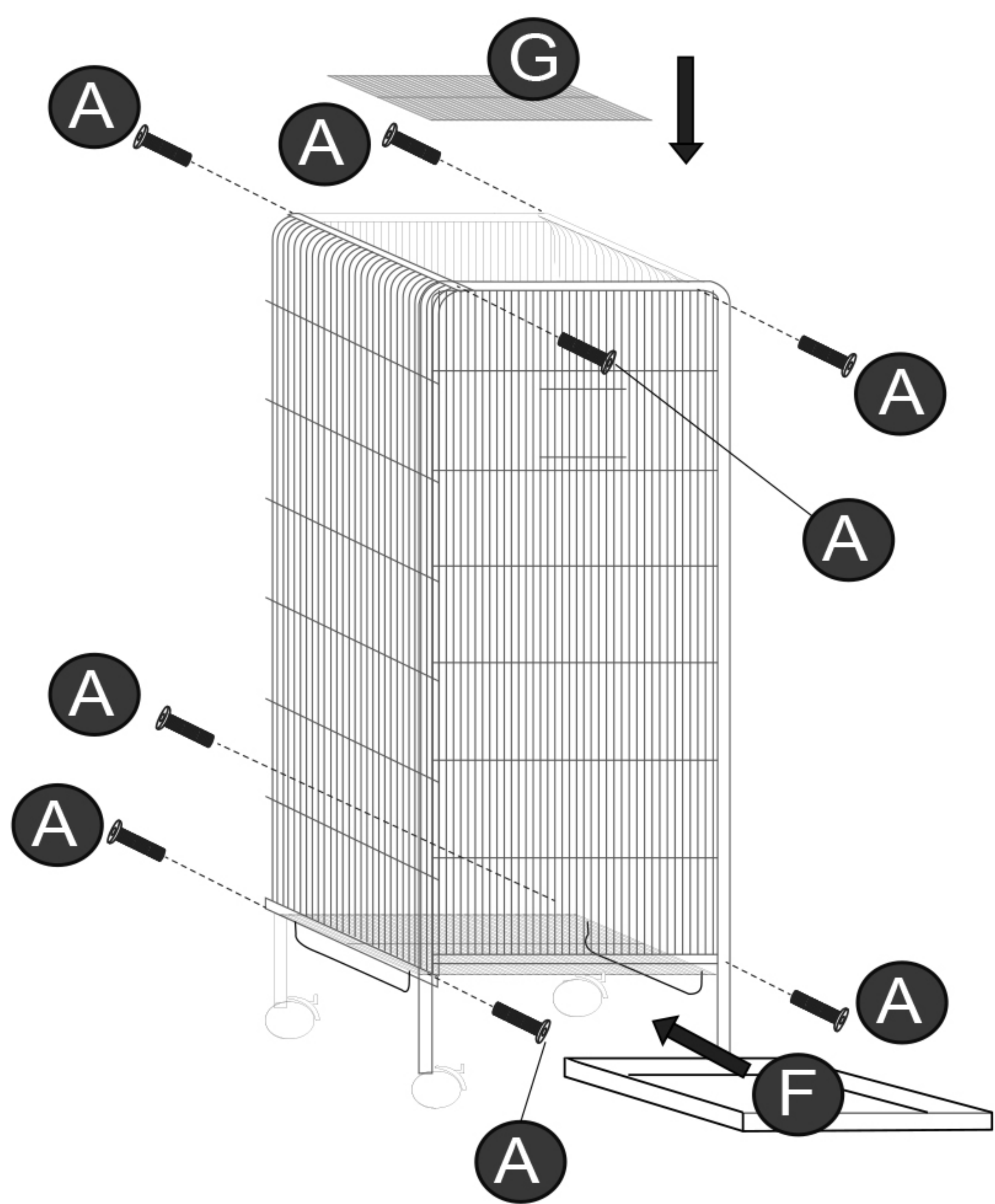

A:8pcs

④

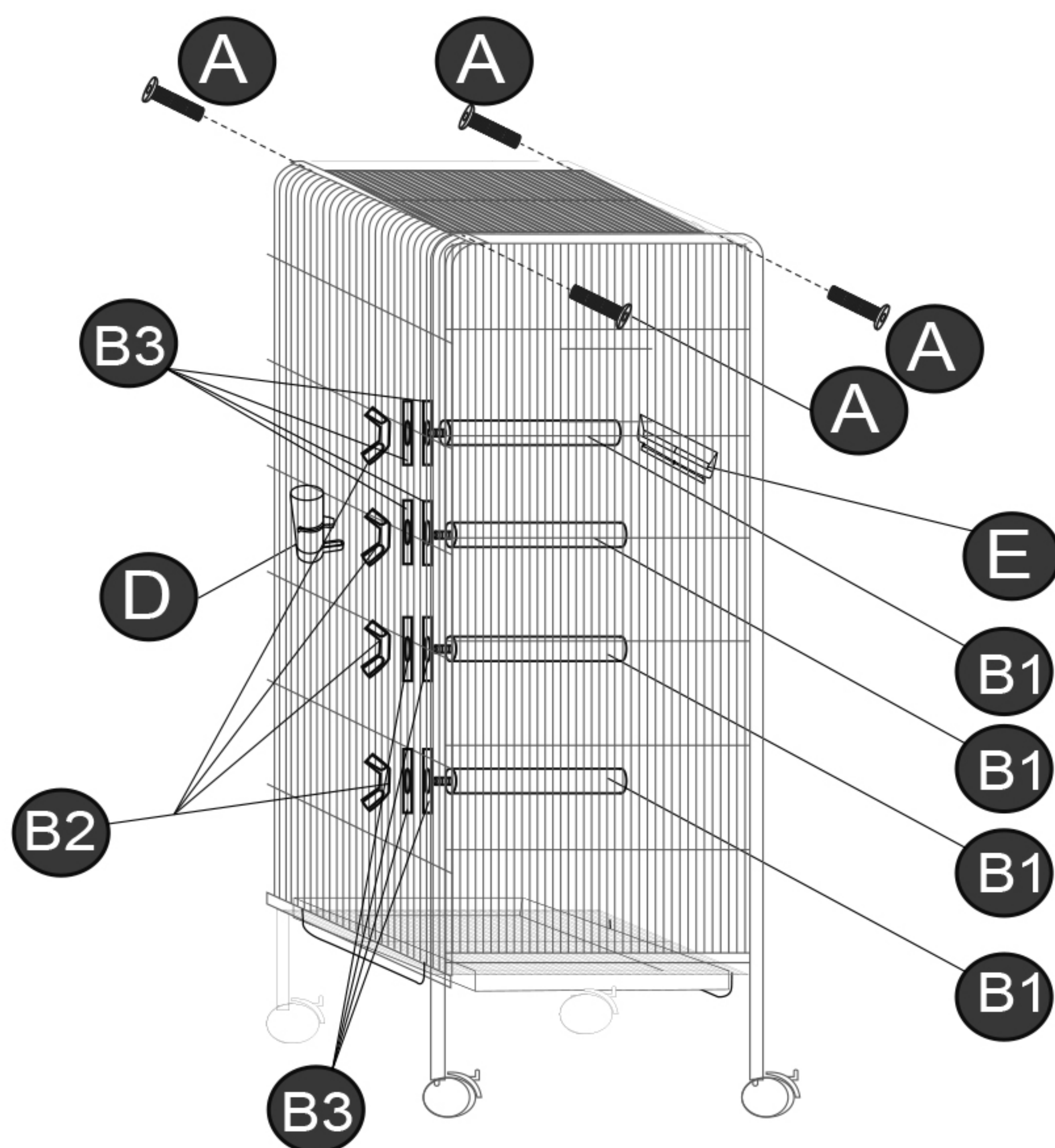

A:4pcs