



Important Notification:

- Please make sure all parts are intact before installation. When the product is taken out, it would be better to put them on a smooth surface to prevent scratches.
- It might be sharp at the edges and corners as the frame is made of aluminum, please protect yourself from being scratched during installation.
- Standing on a safe platform when working at heights.
- Be sure there are no hidden cables or pipes on the wall before drilling.
- Wearing appropriate goggles when drilling.
- Be careful when using power tools near water.
- The main power must be turned off before the electrical installation.
- The product is indoor use only.
- The electrical components must keep away from moisture.
- This product is manufactured to IP44 grade standard.

Wall Types:

- The fixtures provided are usually used for solid walls.
- If mounted on a tile, please use a ceramic drill and insert a wall plug under the tile.

Accessorize includes:

Typ	Draw	Number	Name
1		2PCS	Rubber Plug Screws
2		2PCS	Mental Screws
3		1PC	Mirror (Equipped with Wire)

Tools needed:

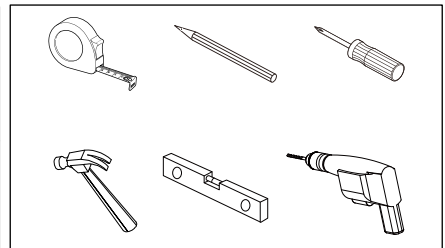

Installation Steps:

1. Confirm the location:

Please mark the hole locations on the wall according to the hole spacing on the back of the mirror, and drill the holes by the marks, then insert the rubber plug screws (NO.1 in the pic) into the wall. Please remember that install at least 2 screws to ensure the stability.

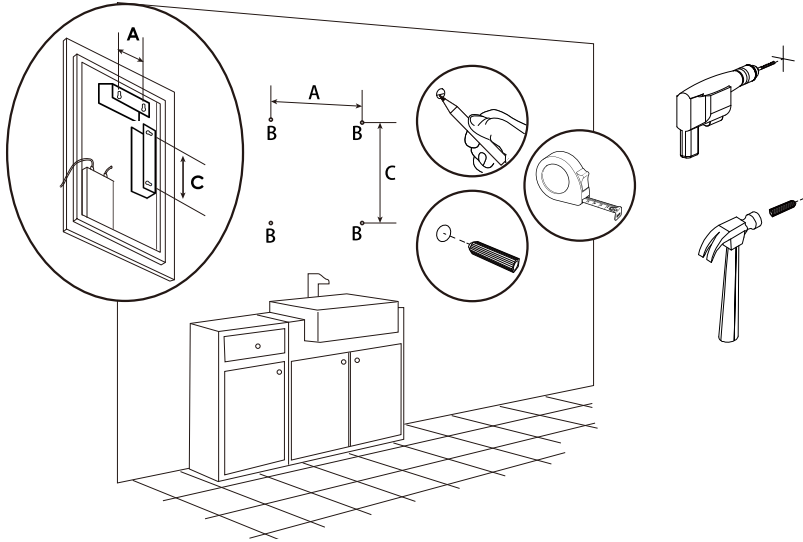

2. Install the mirror:

Turn the metal screws(NO.2 in the pic) into the rubber plug screws and leave gaps, then hang the mirror according to the corresponding holes position.

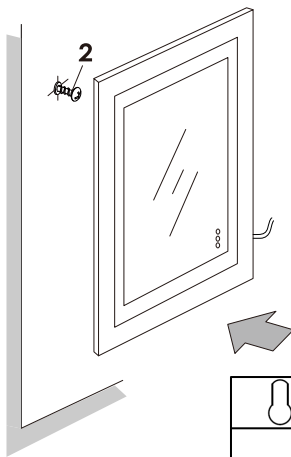

Note:

When mounting to the wall, the wire can not be pressed between the mirror and the wall, otherwise the wire installation will be affected.

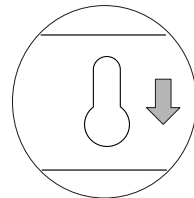

3. Install the plug:

Please purchase an appropriate plug to access the live wire (L) and naught wire (N), ensure safe use.

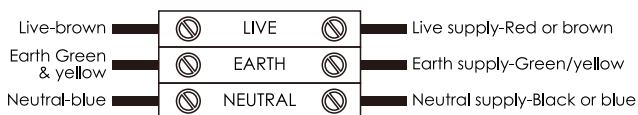
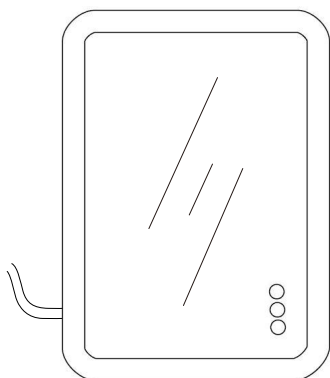

4. Test

After the installation is complete, please test whether the LED lights are normal. If not, please check if the plug and wire are successfully installed. Have any questions, you could contact the service team freely for help.

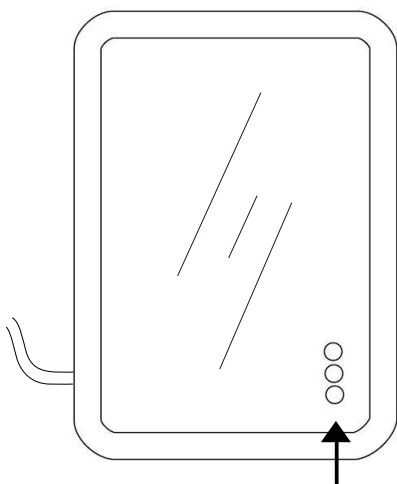

Thank you for purchasing this product. If you have any questions, please contact our customer service department. We are always willing to help you.