

## SPECIFIC OPERATION

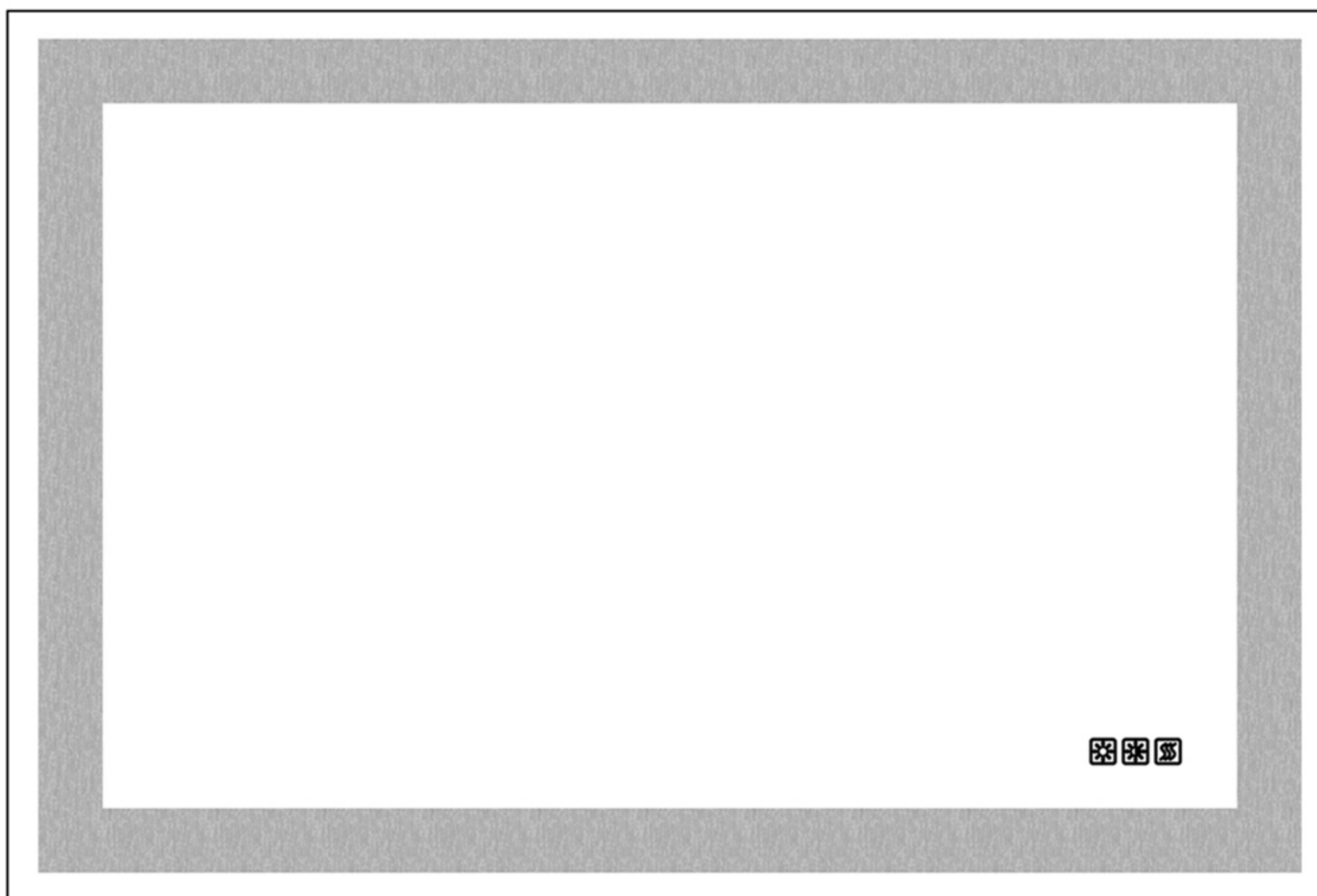

Button 1:

The first time you click, turn on the light  
short press, Open the warm light  
short press, Open the neutral light

Three different light sources can be switched at the touch of a switc



Button 2:

when three-color light on, this key is valued to below function:

The first long press brightens the light.

The second long press dimmed the light.



Button 3:

With the lights on:

Click the defogging button, The defogging function is in operation

# INSTALLATION PROCEDURE

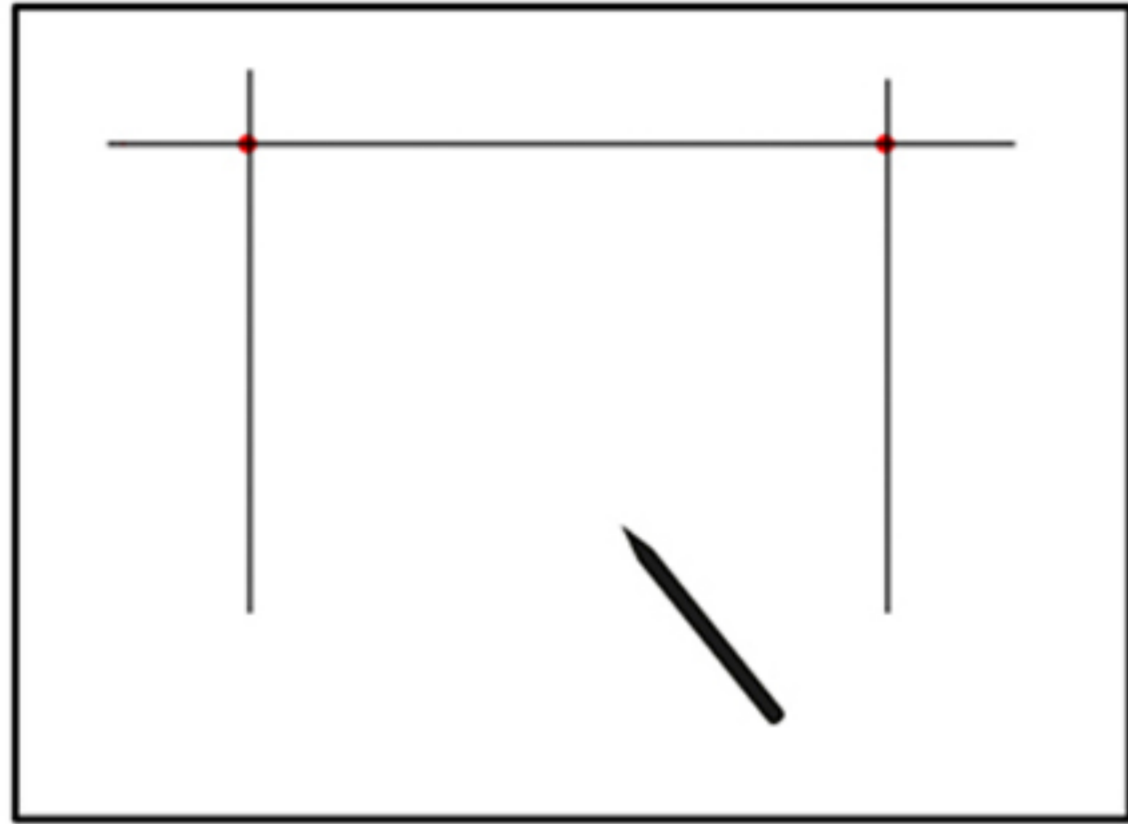

MEASURE THE DISTANCE  
BETWEEN TWO POINTS

①

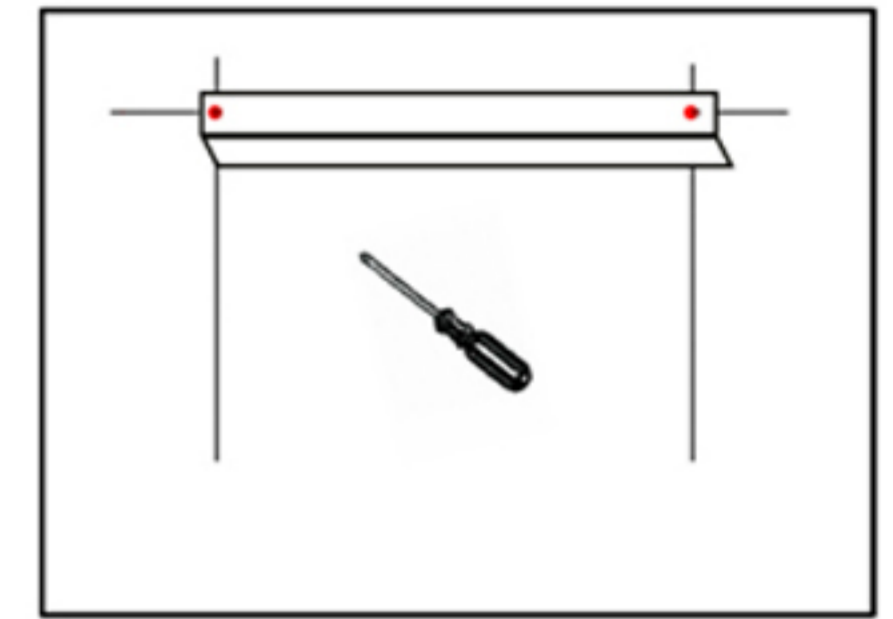
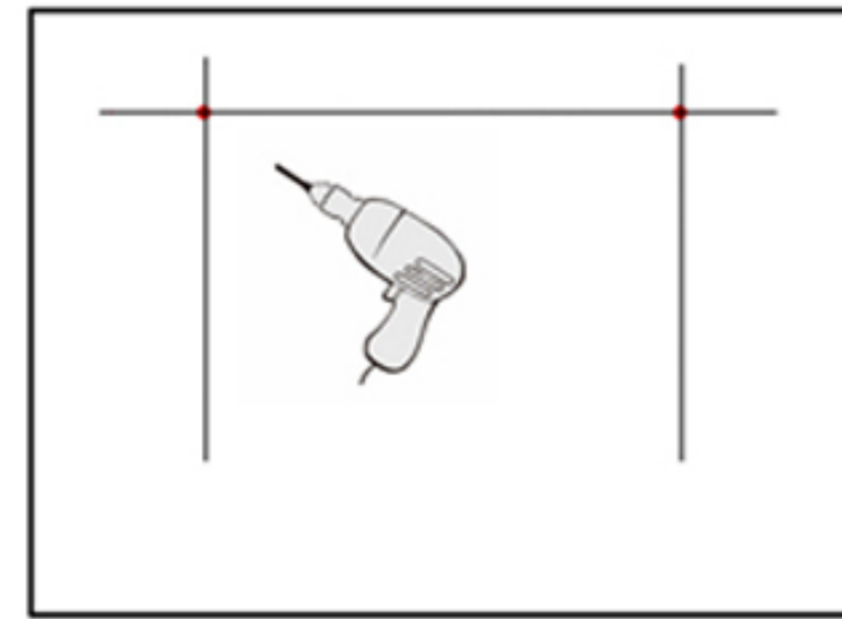

PUNCH HOLES IN THE MEASURED  
POINTS AND DRIVE THE SCREWS

②

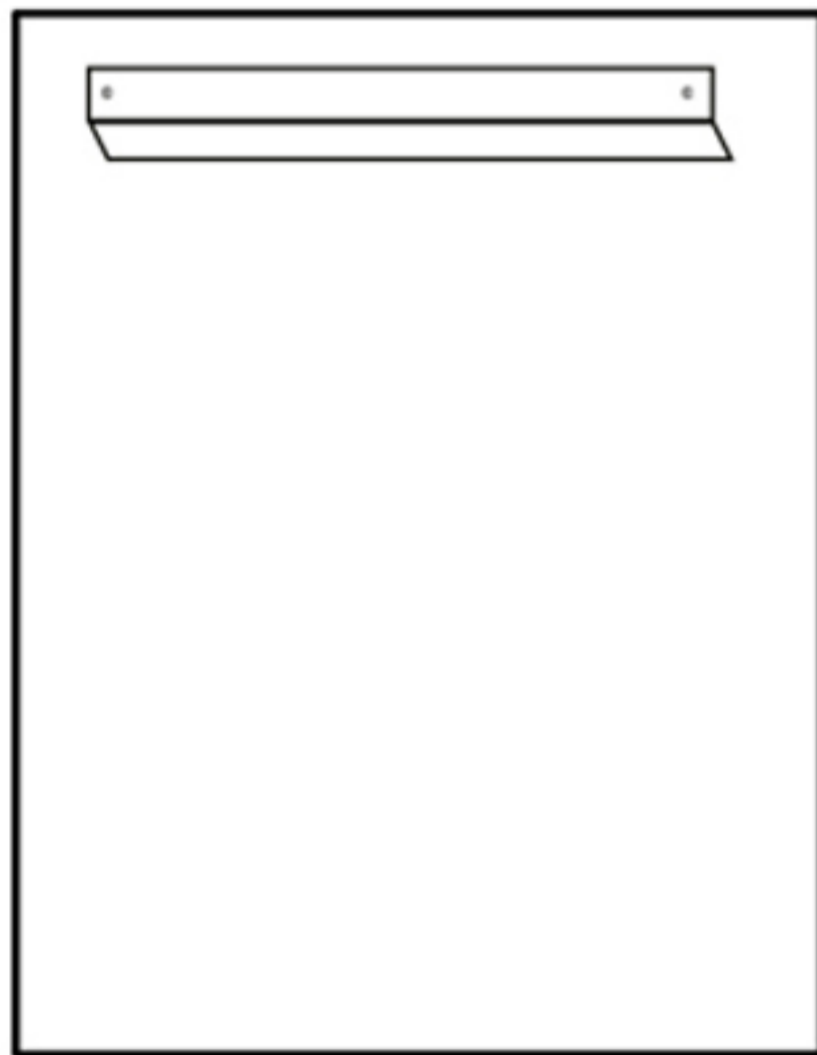

INSTALL Z-BAR

③

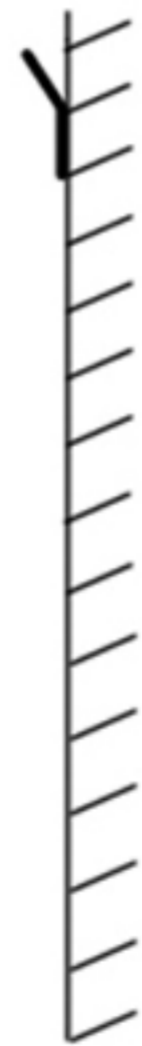

④

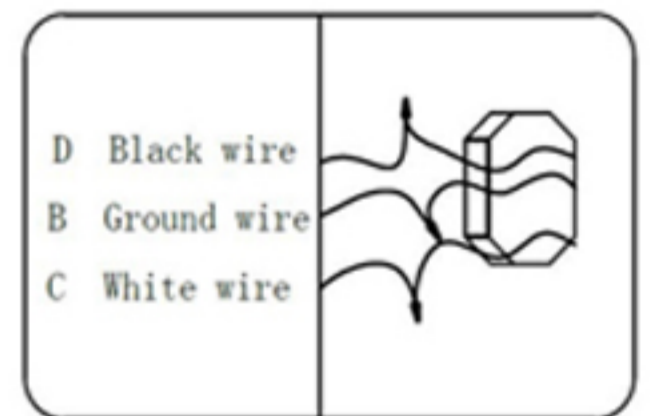
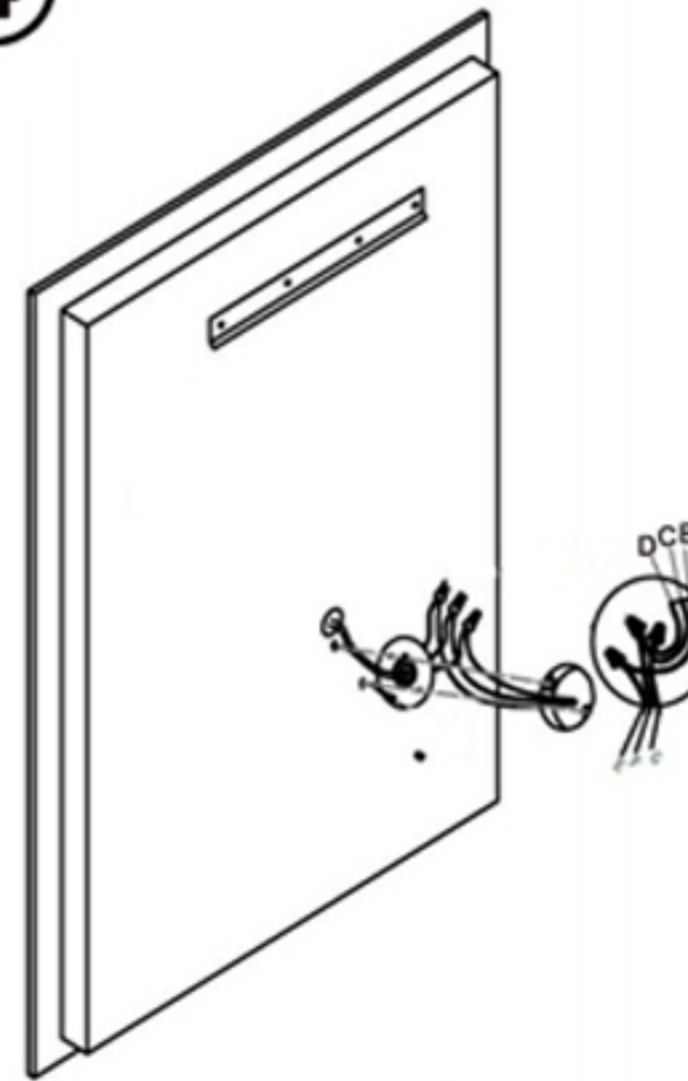

ACCURATELY  
CONNECT WALL  
WIRING

# INSTALLATION PROCEDURE

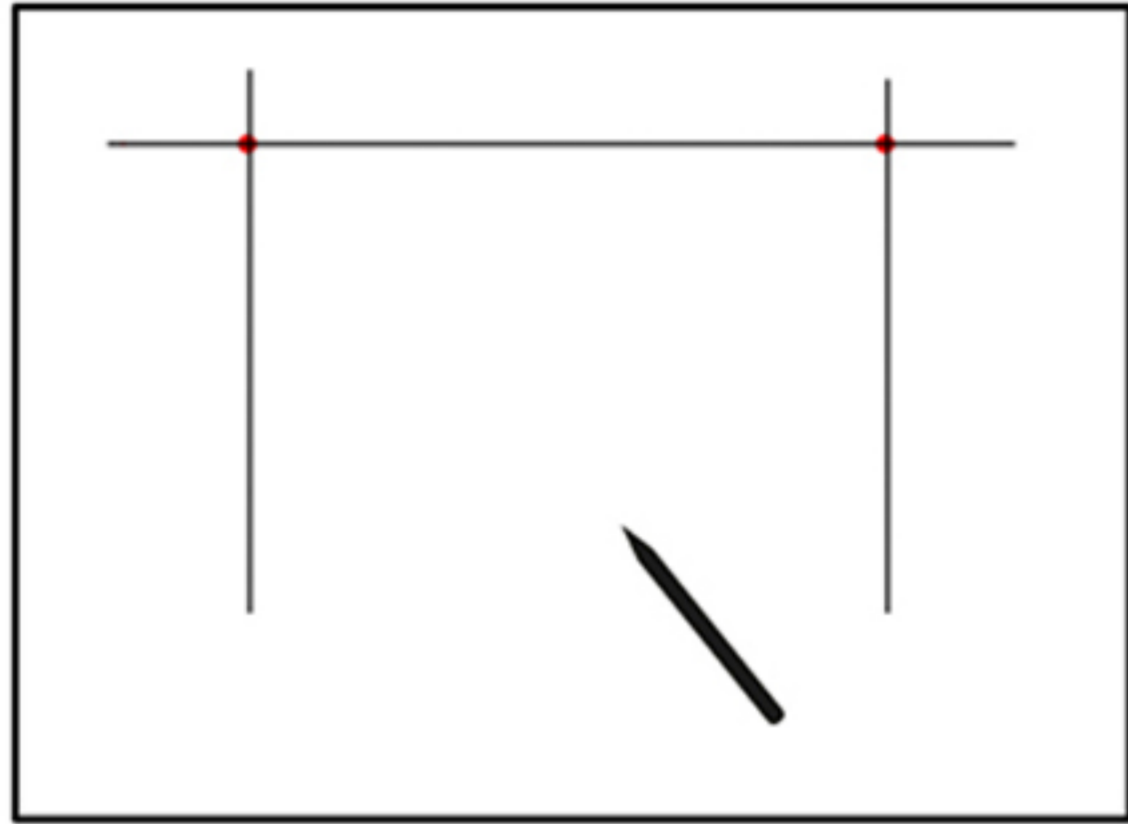

MEASURE THE DISTANCE  
BETWEEN TWO POINTS

①

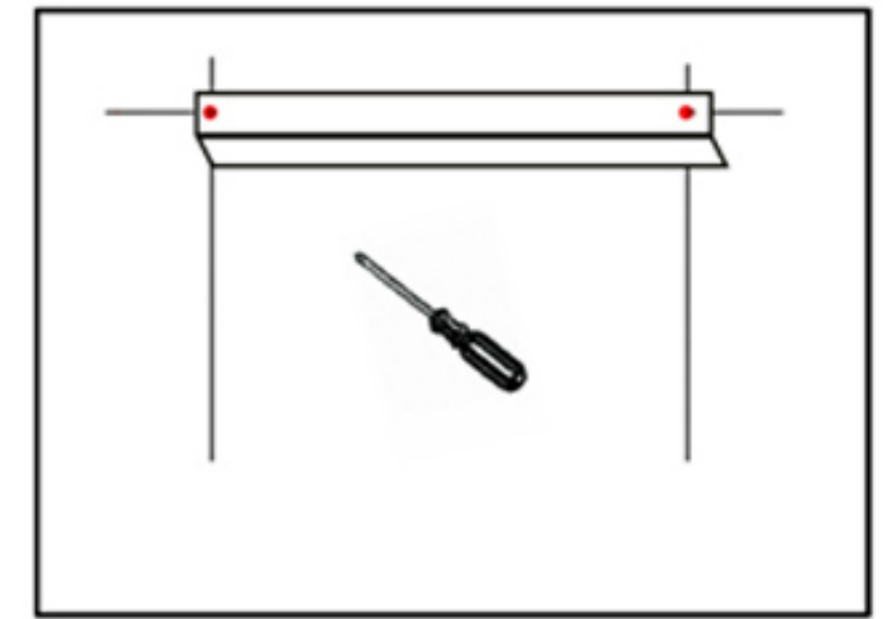
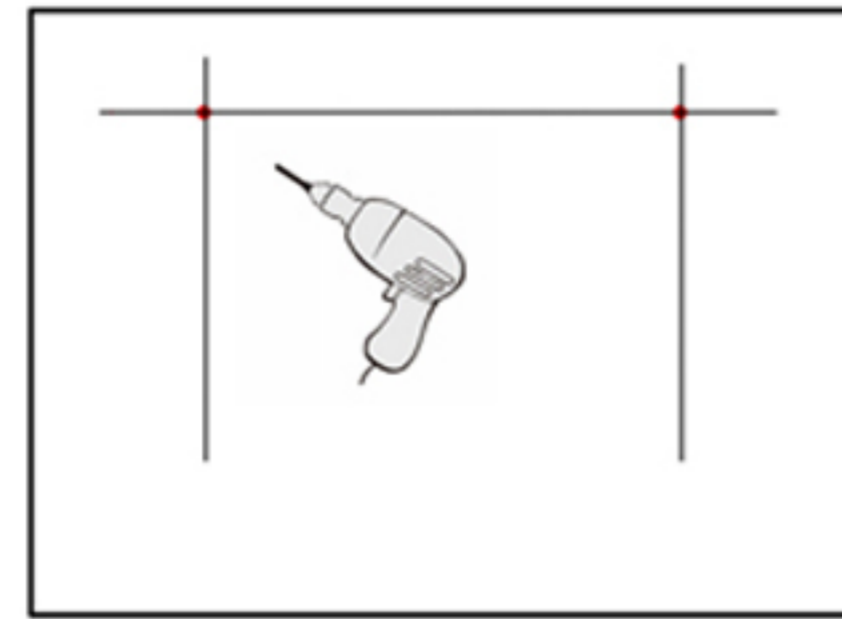

PUNCH HOLES IN THE MEASURED  
POINTS AND DRIVE THE SCREWS

②

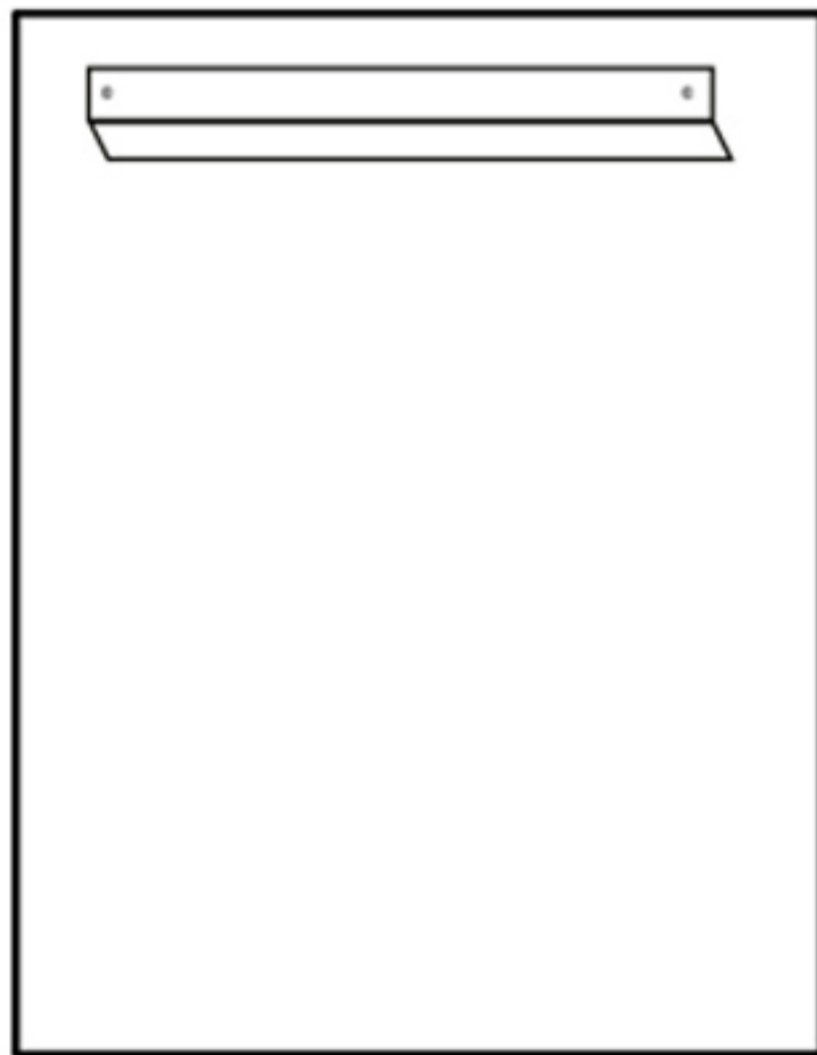

INSTALL Z-BAR

③

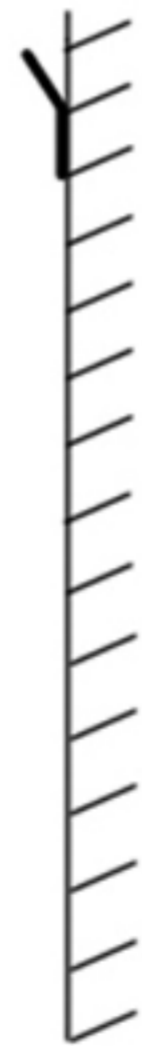

④

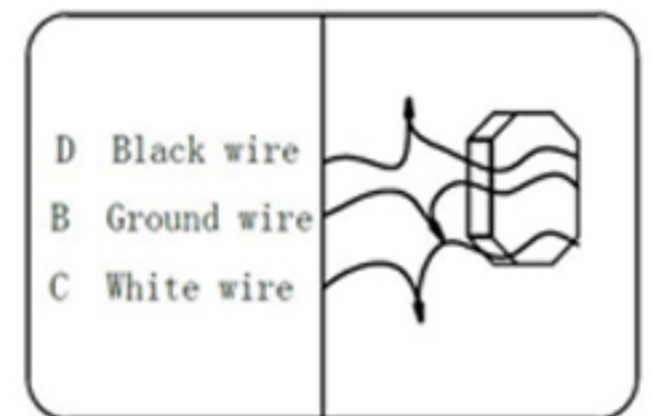
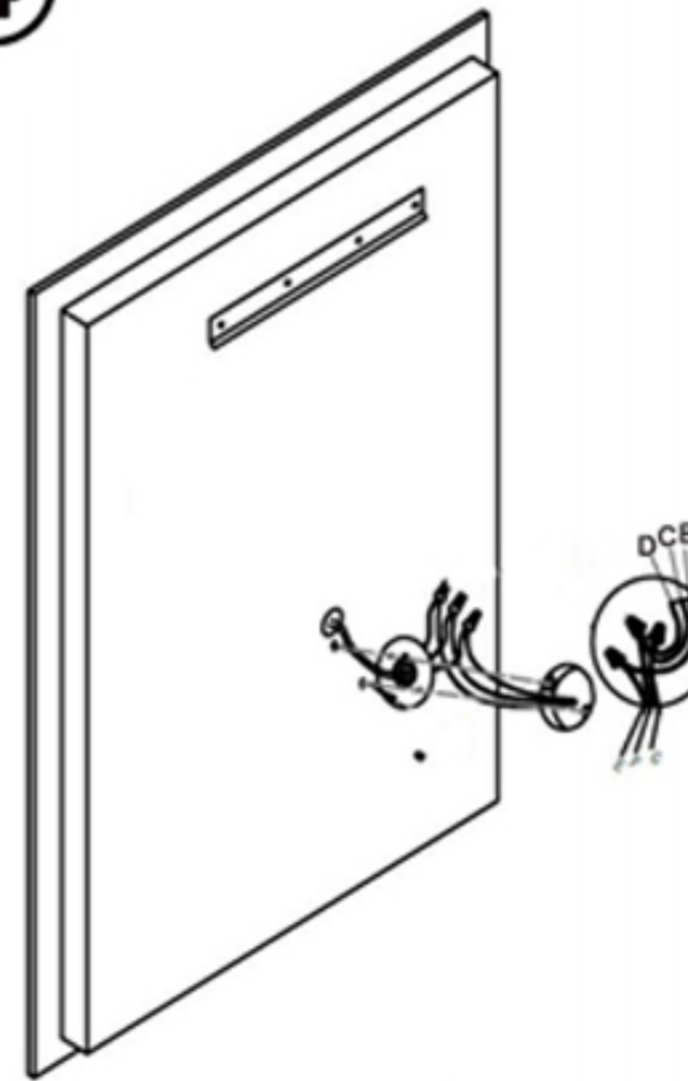

ACCURATELY  
CONNECT WALL  
WIRING