

# LED Vanity Lamp

# 9558-5T

## INSTALLATION SHEET

### NOTE:

- \* Make sure **POWER** is **COMPLETELY OFF** at the fuse box
- \* Have your fixture installed by a qualified licensed electrician
- \* Prepare everything in a clear area
- \* Wear gloves at all time during this installation
- \* Read instructions carefully before you start assembly
- \* Keep this installation sheet for future reference

1. Remove fixture from its original package.
2. Separate mounting palate from fixture body by removing canopy screws.
3. Attach mounting plate to electrical junction box using screws provided in hardware package.
4. Secure mounting plate to mounting surface with additional screws.
5. Make proper electrical connections (black to hot "L", white to neutral "N", ground to "GND") with wire nuts provided in hardware package.
6. Attach mounting plate to holes on fixture body, and then attach using canopy screws.

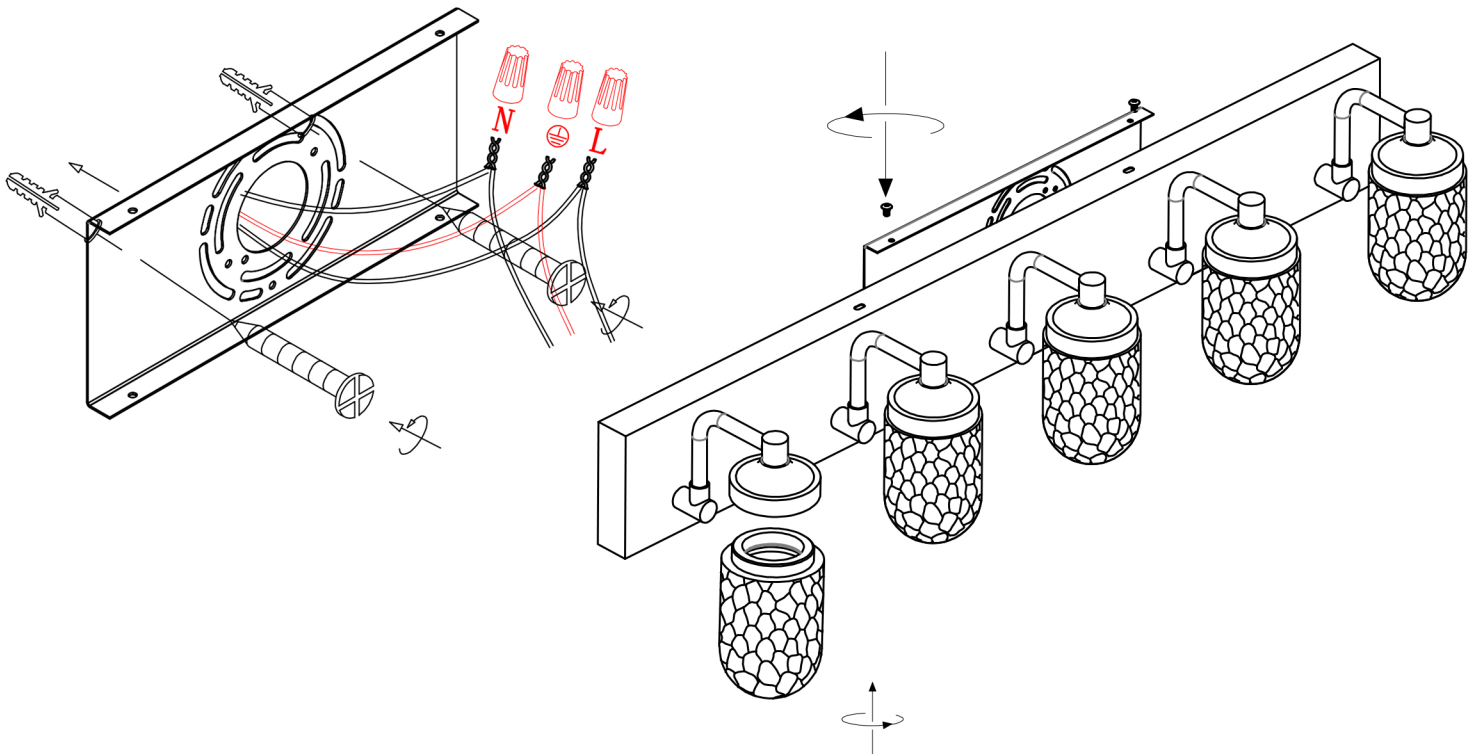

9558-5T