

TSMZ01-004A

User Manual

Size:

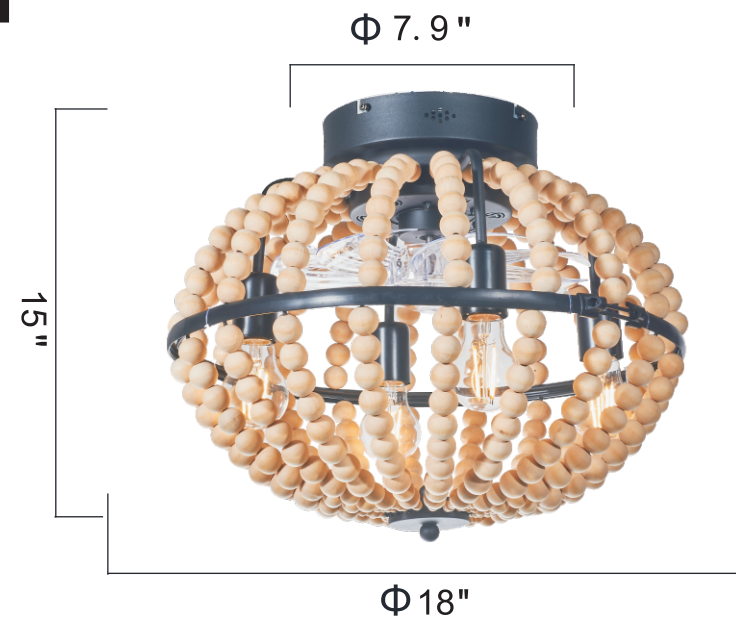

Fan lamp remote control instructions

Remote control key function:

- ⏻: Main switch
- ⏻: Light switch
- 🌀: Natural wind
- ⏻: Fan off
- ⚙️: Fan gear key Gear 1-6 Forward
- ⌛: rotation
- ↺: reversal
- 1H: Fixed time 1 hour
- 2H: Fixed time 2 hours+pair key
- 4H: Fixed time 4 hours

Remote control battery : No. 7 1.5V*2

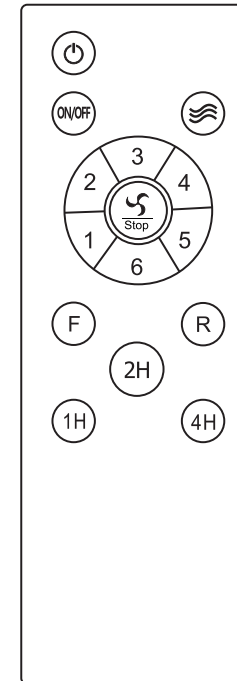

Remote control instructions :

① . If the remote control is not used for a long time , Please remove the battery.

② . Remote control matching code :

Turn on the power , Press the pair code button within 5 seconds of the light on ,

When you hear two "tick" sound or the light flashes, the code matches successfully.

If you need to match the code again , You need to wait 30 seconds before turning on the power

and repeat the above operation.

Installation instructions:

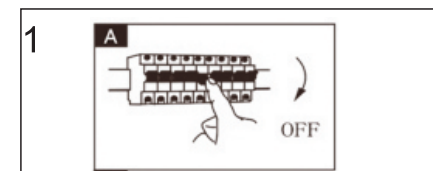

Please confirm whether the voltage is consistent with the product, and turn off the power supply at the installation position to ensure safety.

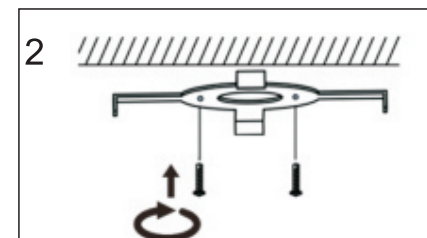

Screw the hanging plate to the ceiling correctly

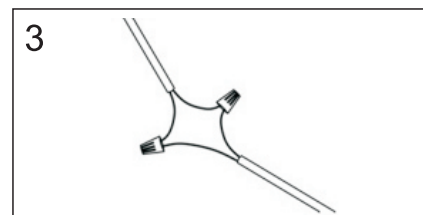

Connect the lamp drive input to the power supply correctly and firmly

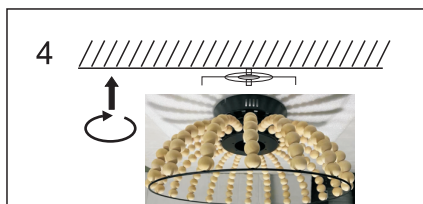

Rotate the lamp body to make the screw of the hanging plate correspond to the hole of the leftmost hub

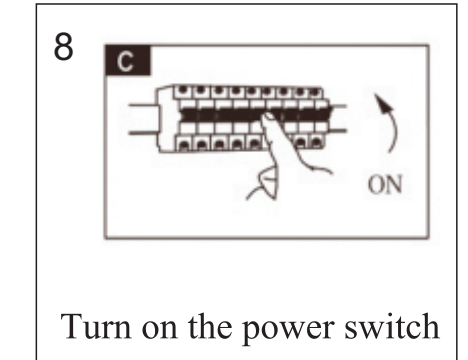
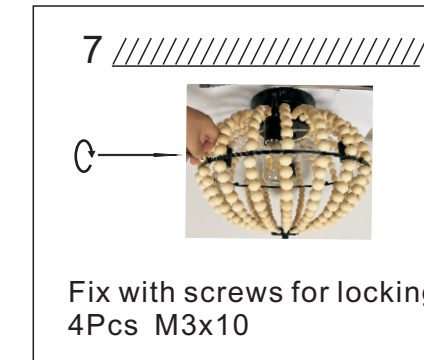
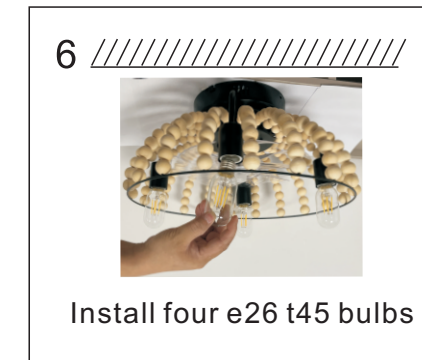
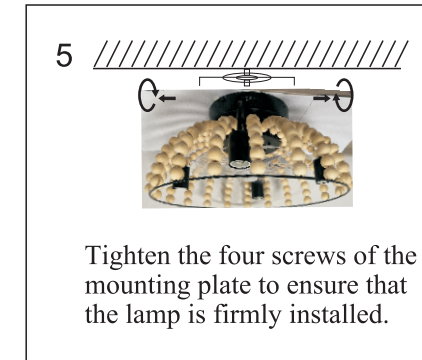

Precautions:

Do not disassemble and modify the goods by yourself to avoid electric shock
Do not use the product in high temperature, high humidity or outdoor places.

Please clean the lamps with a dry soft cloth, and do not wipe the lamps with corrosive detergent.

Do not use multiple electrical appliances in the same socket at the same time to avoid short circuit or fire.

During cleaning and maintenance, the operating instructions and precautions should be followed to avoid the danger of electricity.

Pay attention to the condition of ceiling fan lights at any time. If there is any malfunction, stop using them immediately and contact the maintenance station designated by the manufacturer for maintenance. Do not replace parts or disassemble and repair them by yourself and pay attention to regular maintenance to ensure safe use.

Prevention method:

Please immediately turn off the power supply and stop using it in the following situations:

When the main lamp is wet or comes into contact with liquid/rain

When the main lamp falls and is damaged.

Smoke, sparks, etc. occur in the lighting lamps.

LED light source flashes abnormally or is damaged.

Packaging accessories:

Fan lamp body*1
Instructions (assembly instructions)
Remote control
Parts package

Warning:

This appliance is not intended to be used by users (including children) with insufficient physiology, awareness, mental ability, experience or knowledge, unless it is safely used under the supervision or guidance of those responsible for the safety of women and children. electrical appliances.

This appliance should be installed with fan lights according to the instructions, and adhesive is not allowed.

When installing electrical appliances, the fan blades should be more than 2.3m above the ground (for electric fans installed at high places).