

Ceiling Fan Light

Package contents

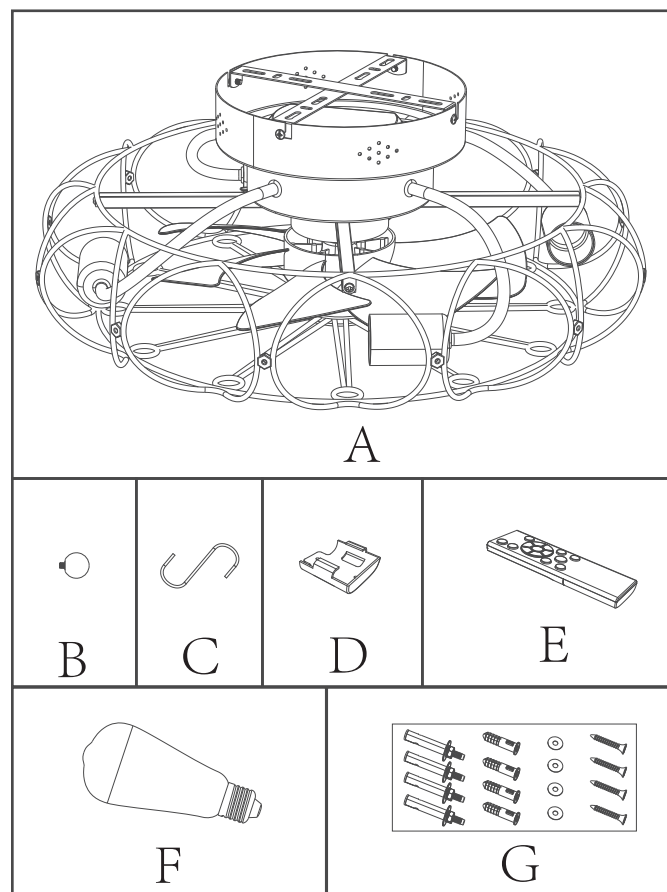

- | | |
|---|------------------------------------|
| A. Ceiling fan light x 1 | D. Remote control wall bracket x 1 |
| B. Decorative ball x 15 | E. Remote control x 1 |
| C. S-hook (auxiliary mounting tool) x 1 | F. ST64 LED bulbs x 5 |
| | G. Accessory pack x 1 |

Product assembly

Step 1: Assemble the thirteen decorative balls to the ceiling fan. (fig.1)

Step 2: Install the four LED bulbs onto the light brackets.(fig.2)

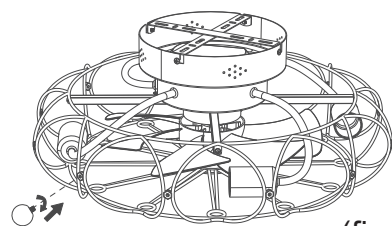

(fig.1)

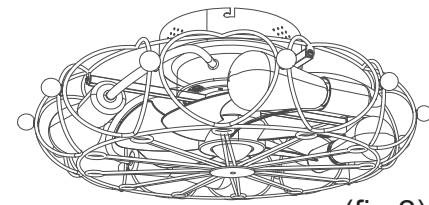

(fig.2)

Mounting options

a : Wooden ceiling

If you have a wooden ceiling, use wood screws with flat washers.(fig.3)

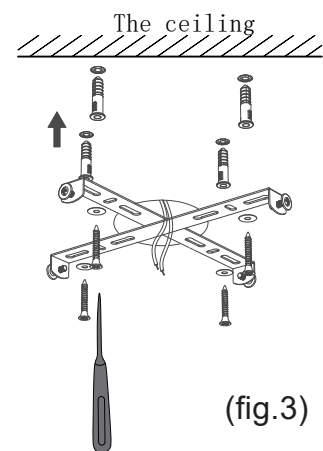

(fig.3)

b : Concrete ceiling

If you have a concrete ceiling, use screws with lock washers.(fig.4)

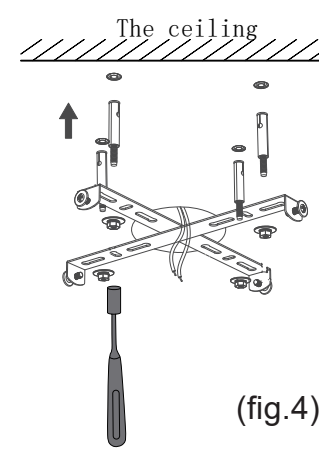

(fig.4)

Installation

Step 1: Use the auxiliary mounting tool S-hook to hang the ceiling fan with light under the ceiling.(fig.5)

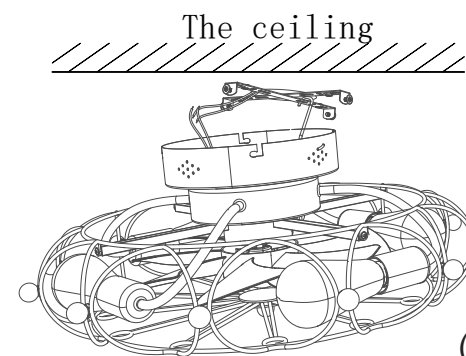

(fig.5)

Step 2: Wiring(fig.6)

a.Connect the black live wire marked "L" on the receiver to the live wire (typically black) on the socket box.

b.Connect the white neutral wire marked "N" on the receiver to the neutral wire (typically white) on the socket box.

c.Connect the ground wire (bare wire) from the base of the ceiling fan base with the ground wire (bare wire) of the socket box.

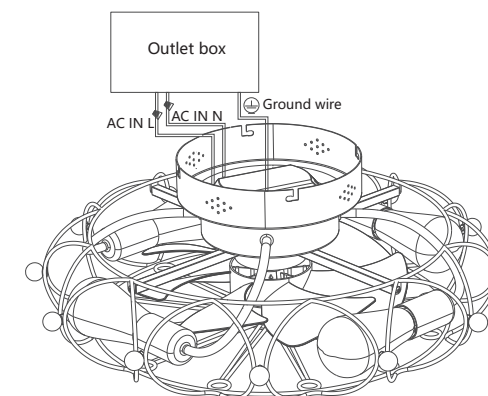

(fig.6)

Step 3: Remove the S-hook and snap the 7-shaped hole of the ceiling fan light holder onto the cross-hanging plate.(fig.7)

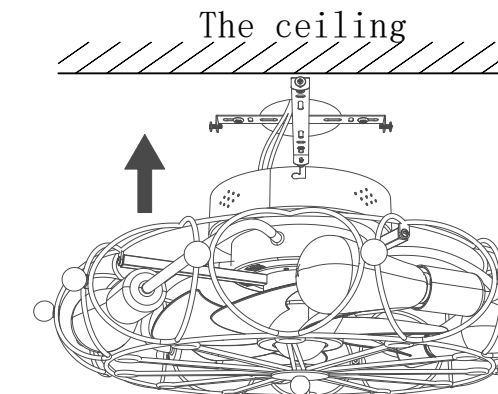

(fig.7)

Step 4: Rotate the ceiling fan and snap the screws into the 7-shaped holes.(fig.8)

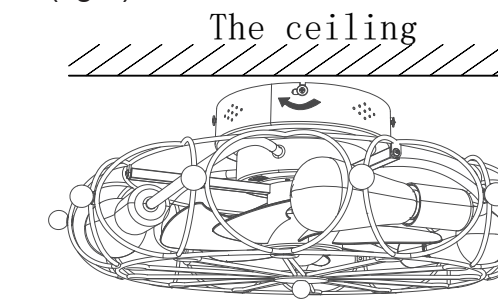

(fig.8)

Step 5: Tighten the 4 screws to complete the installation.(fig.9)

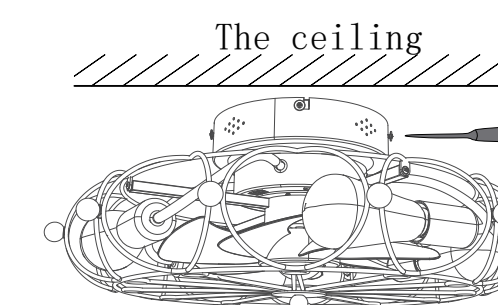

(fig.9)

Manual

Important: Please read and understand this manual before any assembly. Before assembling this product, please ensure that all parts are in place. Compare the details with the product display presentation. If you have any questions, don't hesitate to contact us through Amazon.

Warm Tips

If your remote control does not control the fan and lights, please follow the steps below to undo the fault.

Step 1: Replace the battery of the the remote control.

Step 2: Try to program the remote control.

Please turn off the main switch that controls the ceiling fan light and turn it on again. When turning on the light, press and hold the 2H button of the remote control within 5 seconds.

If you hear a beeping sound, the code is matched successfully. Then try again to see if the remote control can control the fan and the light.



Remote control operation

Install the AAA battery. Please take out the battery If not used for a long time to prevent damage to the transmitter.(fig.10)

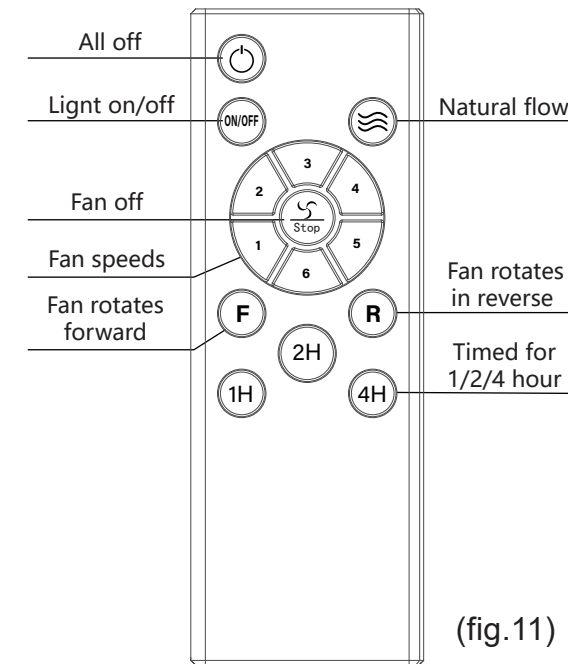
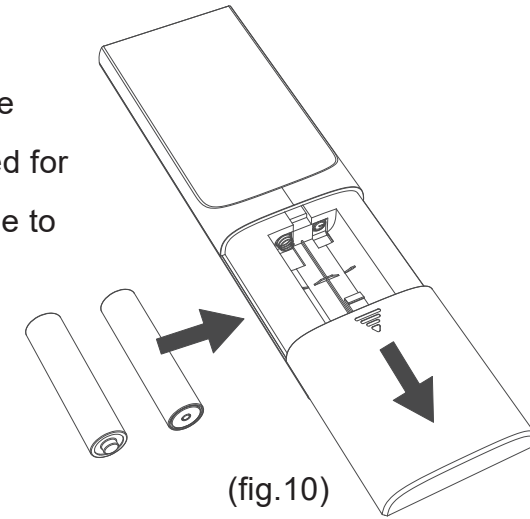

The function of each button of the remote control is explained.(fig.11)



Important safety instructions

Caution!

1. To avoid possible electric shock, make sure the power supply the box or circuit breaker is shut off before wiring.
2. All wiring must be carried out under national and local specifications. Please consult a qualified electrician to ensure that the live, neutral, and ground wires are connected correctly.
3. If you do not have sufficient knowledge of electrical wiring, please have the fan installed by a licensed electrician.
4. The ceiling fan light mounting carrier is solid and can reliably support at least 66 lbs(30kg).
5. Mount the lowest moving parts at least 7.5ft(2.3m) above the floor or ground level.
6. Ensure that all electrical connections are sealed with appropriate connectors and electrical tape in the outlet box.
7. All set screws must be checked and re-tightened if necessary before operating the ceiling fan.

Installation tools

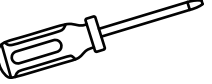
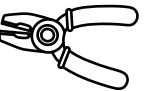
This manual aims to make it as easy as possible for you to assemble, install, operate and maintain the ceiling fan. The tools listed below are required for assembly and installation.

Star-head Screwdriver	
Wire-stripping Pliers	
Stepladder	
Electrical Tape	

Maintenance

Some connections may become loose due to the movement of the fan. Check the support connections, brackets, and blade accessories twice a year. Please make sure they are safe.

Care and cleaning

1. Dust your fan regularly with a soft, dry cloth. Do not use harsh cleaners or materials as they may damage the device.
2. To prevent bending of the blades during Cleaning, support the blades from pressure.
3. Keep the ceiling fan or fan blades clear of water, or it may cause a fire or electric shock, which leads to property loss.

Specifications

Product Name	Ceiling Fan Light	Item Size	20in*7in
Input Voltage	120V	LED	8W*4
Dimensions	10*10ft-15*15ft	Valid Remote Distance	20M
Battery Type	AAA*2	Rotating Speed(rpm)	555-956r/min
Reversible	Yes	Fan Timing	1H/2H/4H

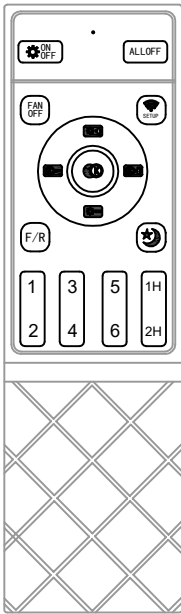

APP



Remote control pair code: long press the "SET UP" key within 5 seconds after the lamp is just power-on, the buzzer rings 1 sound drop, indicating the success of the pair code.



TUM OFF THE LIGHTS AND TURN ON THE LIGHTS



ALLOFF General



night lamp



Three speed color temperature adjustment



Fan stop



Long press or click on this key to increase the brightness. It makes a ticking sound at the brightest time.



Long or click the key to turn dark. It makes a ticking noise in the darkest hour.



Long press this key to increase the color temperature.



Long press this key, the color temperature drops.



The afn turns/reverses



Countdown > 1drop > 1hour



Countdown > 2drop > 2hour



1.2.3.4.5.6 Fan gear 1 gear minimum wind 6 gear is the maximum wind

