









ASSEMBLY INSTRUCTIONS

Parts CT-DI-401-YM

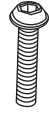
①  x1	②  x1	③  x1	④  x1
⑤  x1			

A  M8*50mm x8	B  x4	C  x1	D  x8	E  x8
--	--	--	--	--

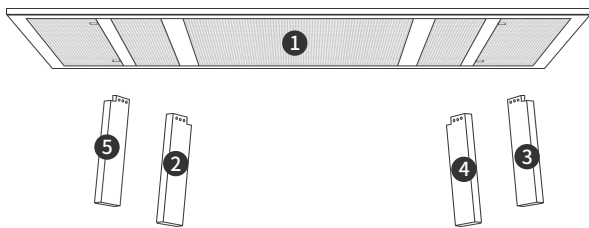
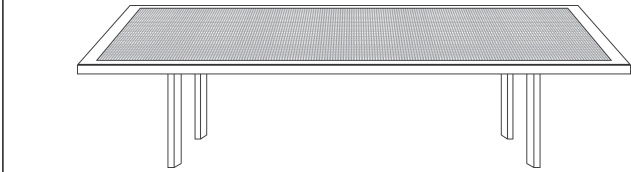

STEP 1 Place B into the holes in the middle of the four positions on the crossbeam (as shown in the figure below).

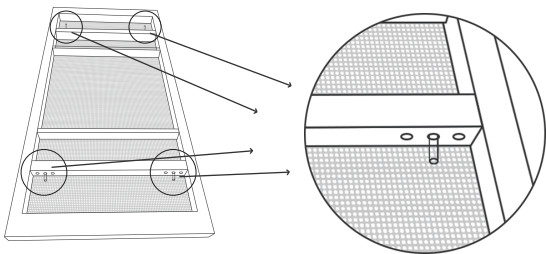

B×4

STEP 2 Place the four support columns 2, 3, 4, and 5 in the designated positions and align them with B to install them.

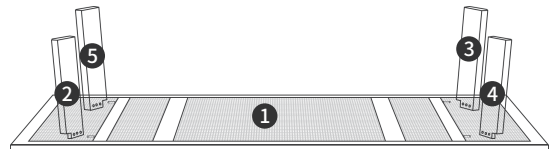

STEP 3 Insert A into D and E in sequence, then place it into the holes of the four support columns and tighten with C.

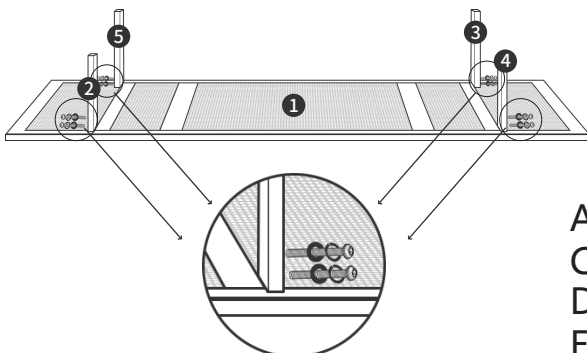

A×8
C×1
D×8
E×8

