

Assembly Instruction

Sofa

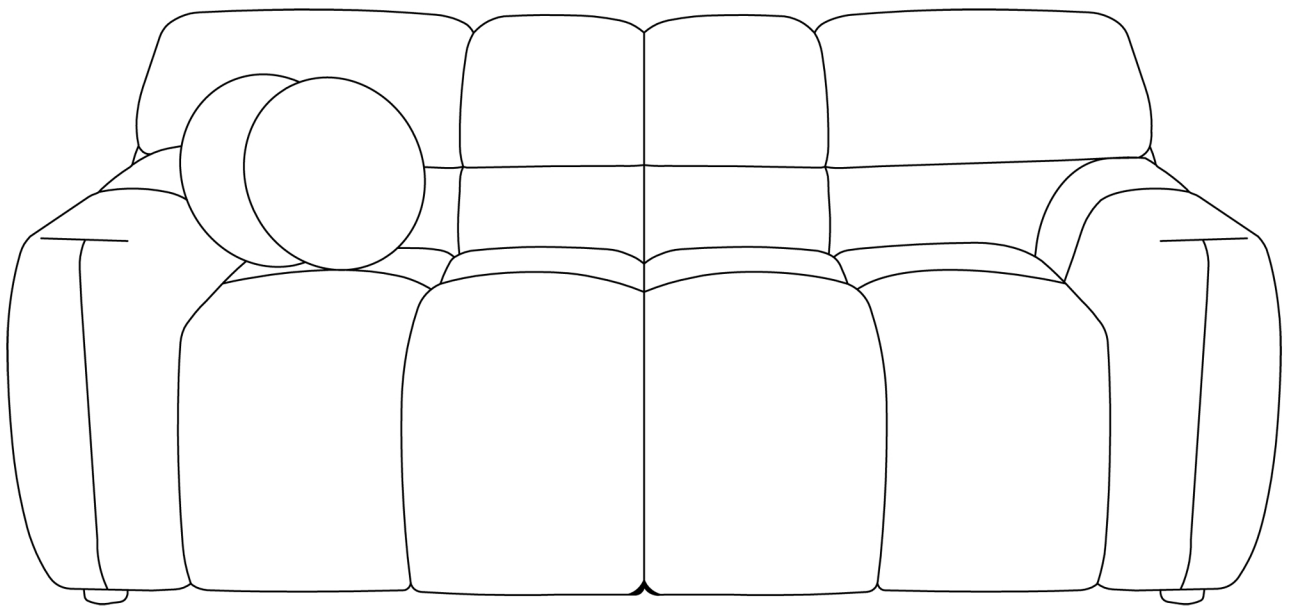
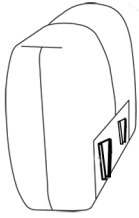
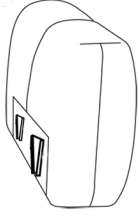
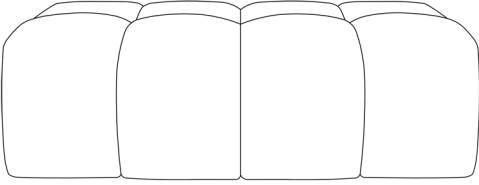
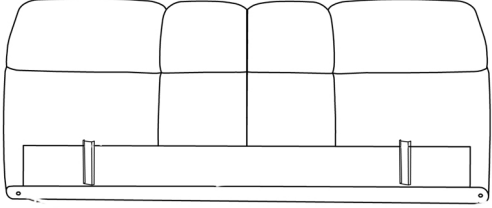
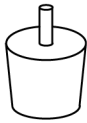
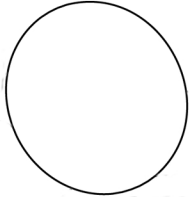

Parts List

Label	Picture	Description	QTY
A		Left Armrest	1
B		Right Armrest	1
C		Seat	1
D		Backrest	1
E		Leg	7
F		Pillow	2

Assembly Preparation

Before Beginning
Assembly:

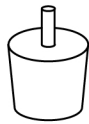
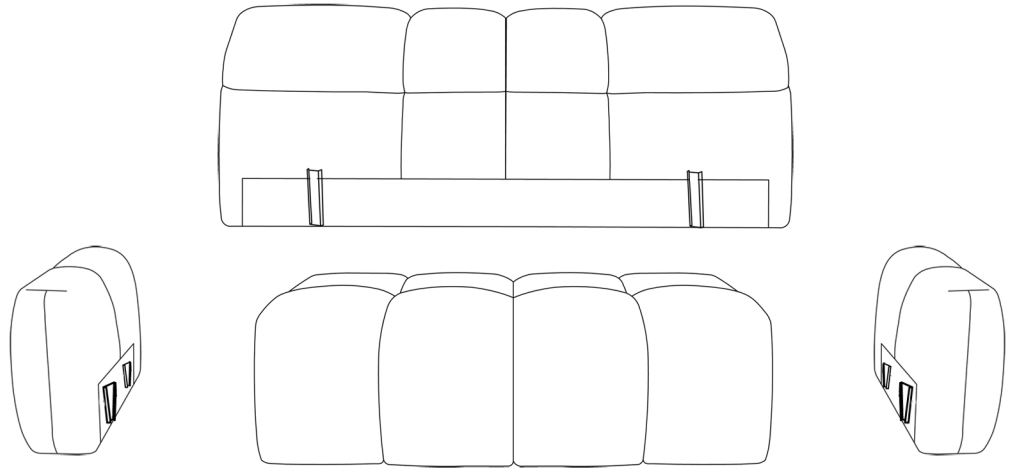

x7

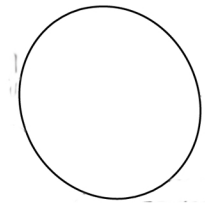

x2



• Read instructions, cover to cover.



• Have 2 adults on hand for assembly.



• Do not assemble on flooring or carpet.



• Assemble on a clean non-marring surface (packing foam).



• Save all packaging until finished.

Step 1

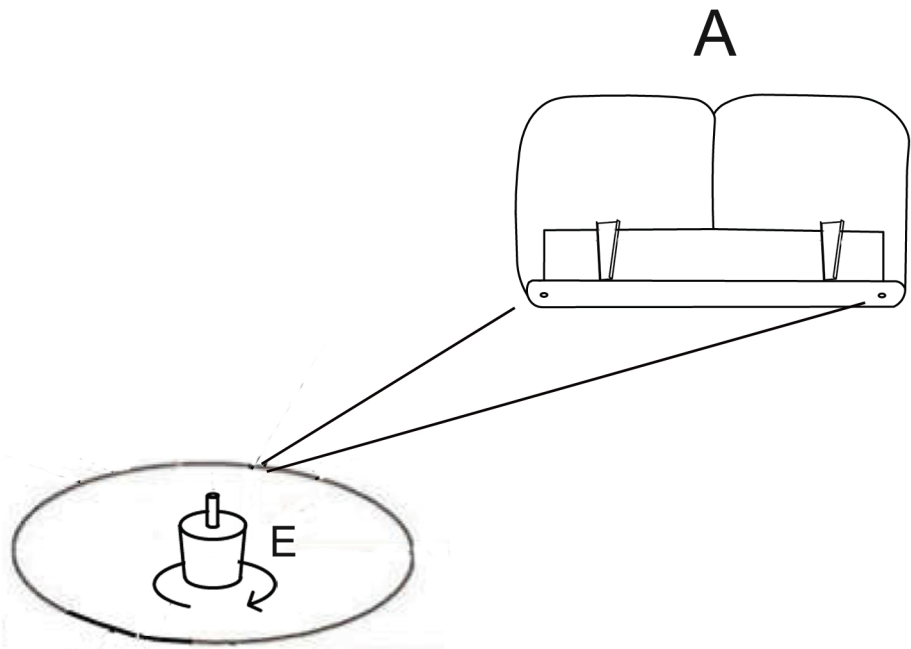
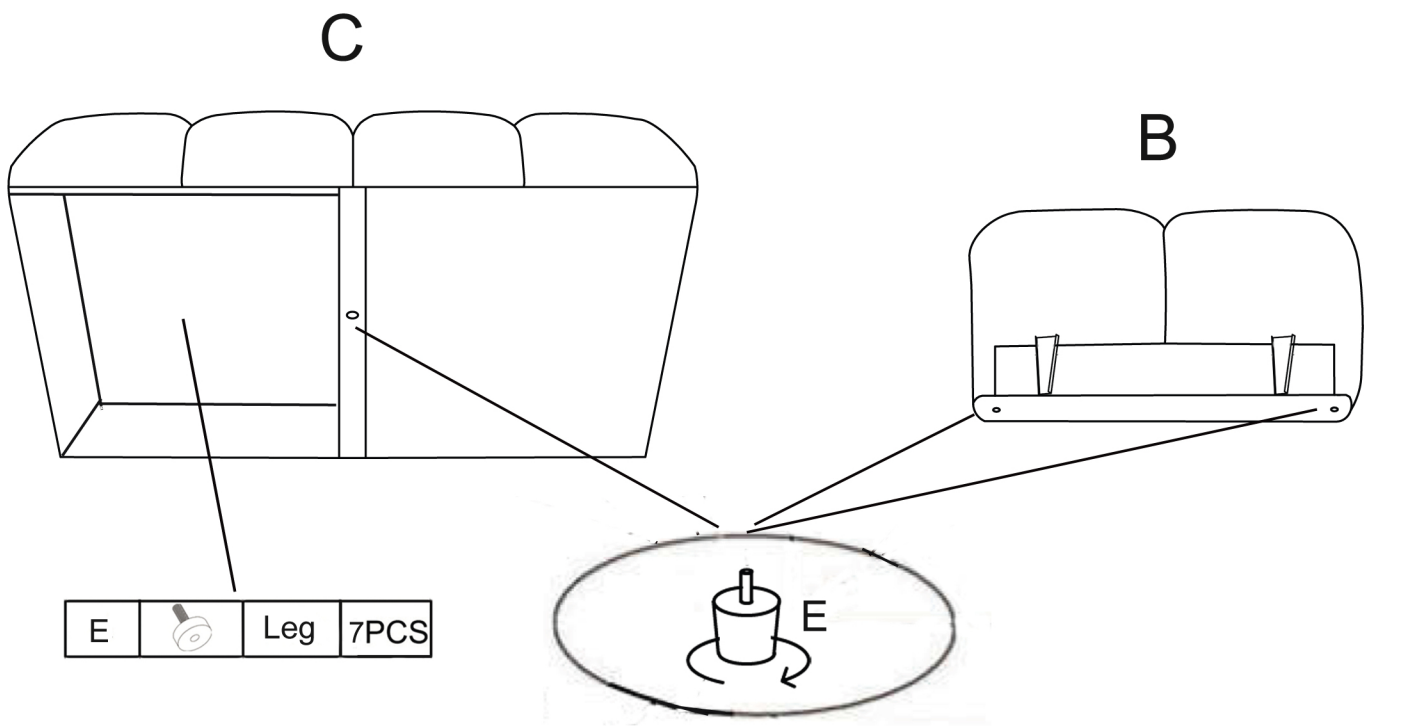

Step2

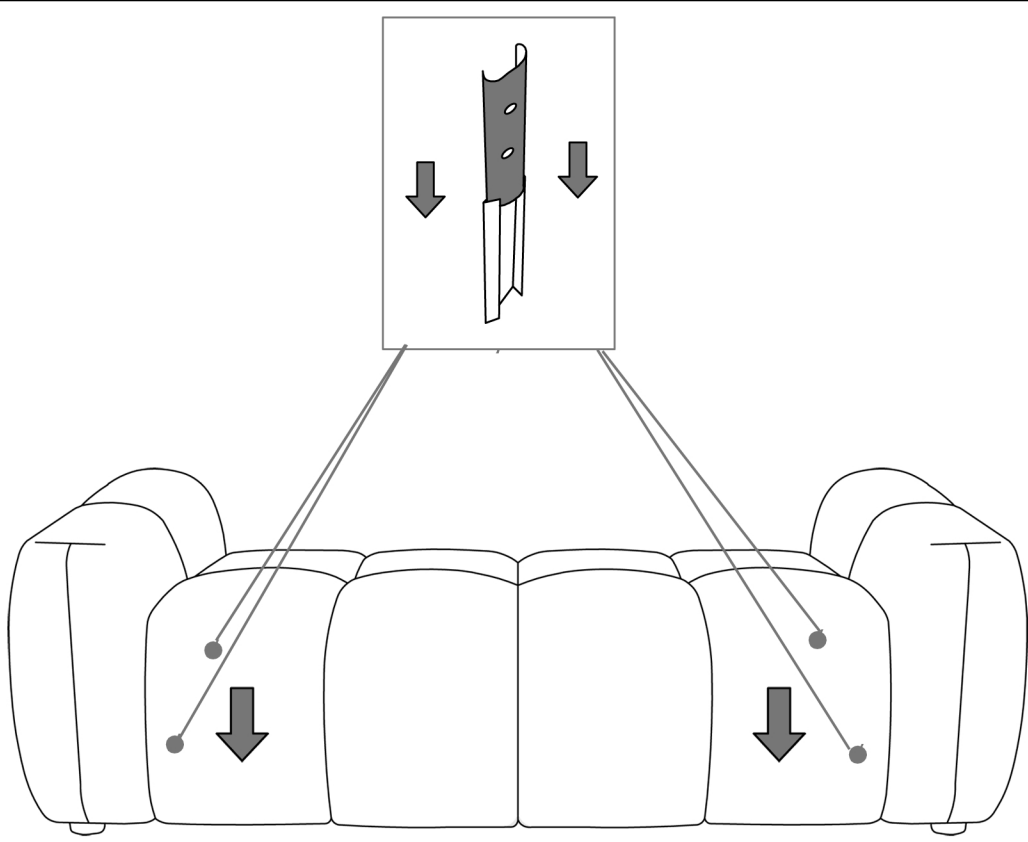

Step3

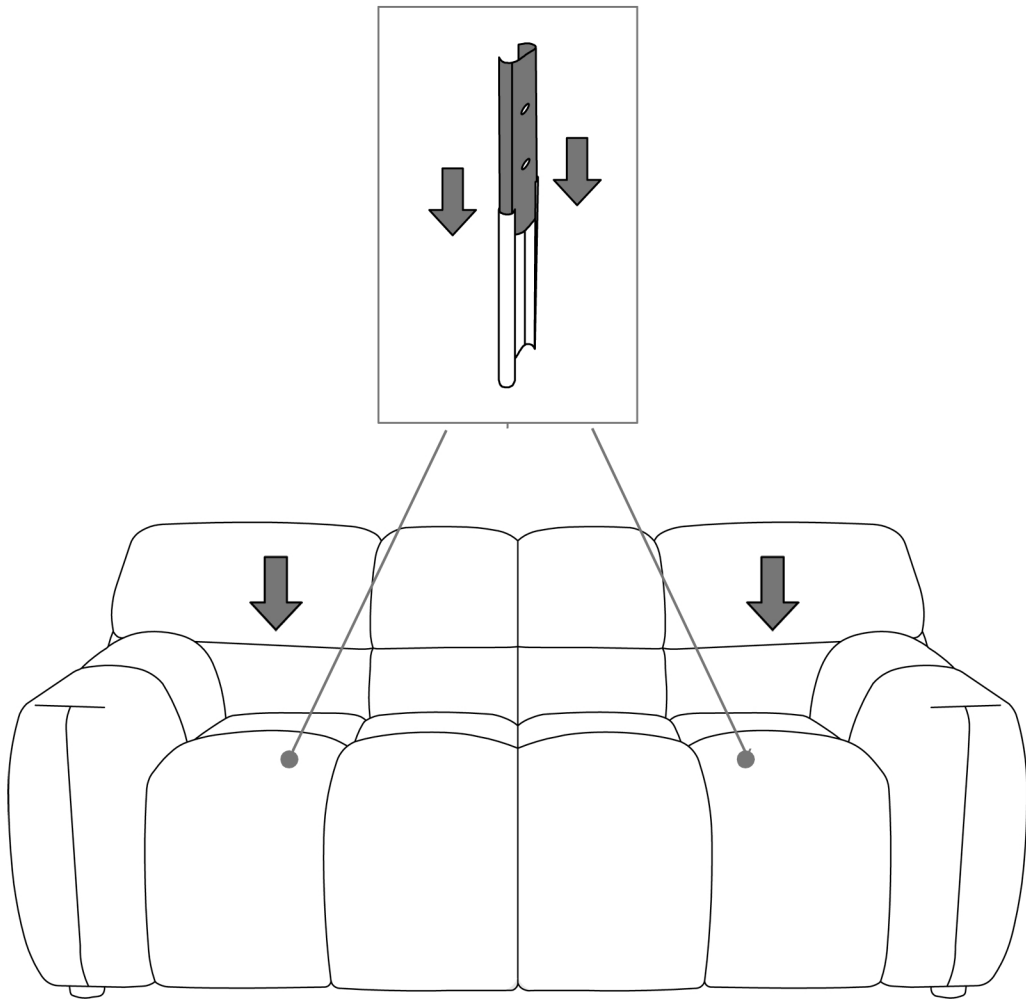

Step4

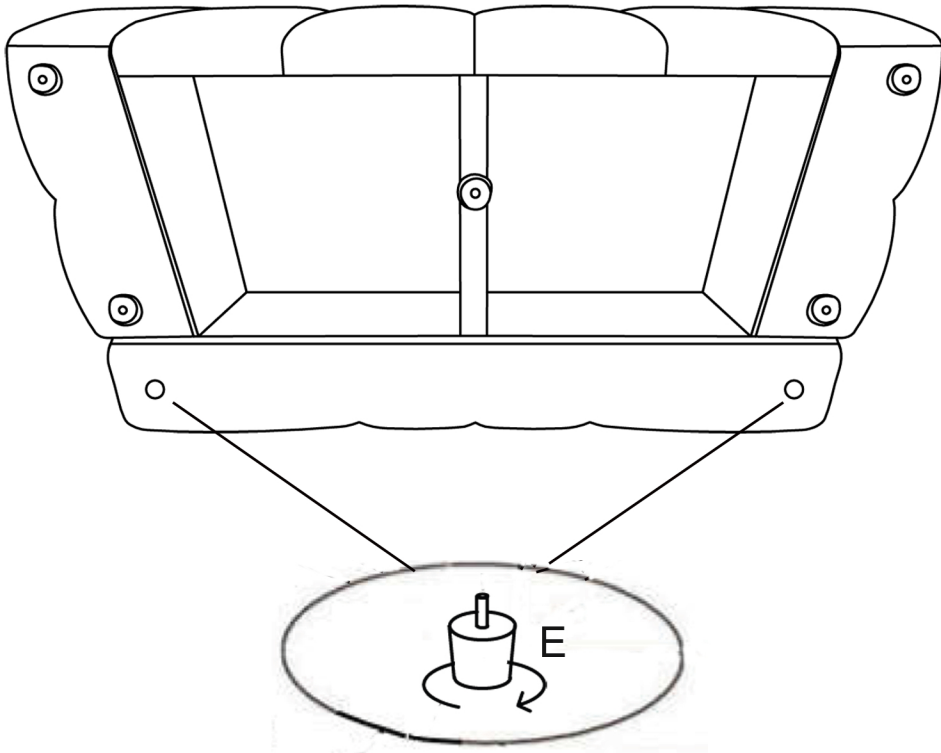

Step5

