

# ASSEMBLY INSTRUCTION

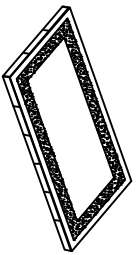

X1

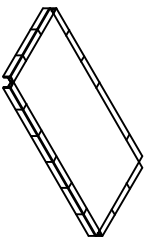

X1

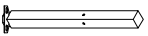

X4



X1



X8



X28



X28



X28

1

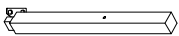
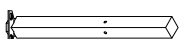
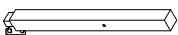
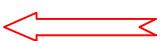
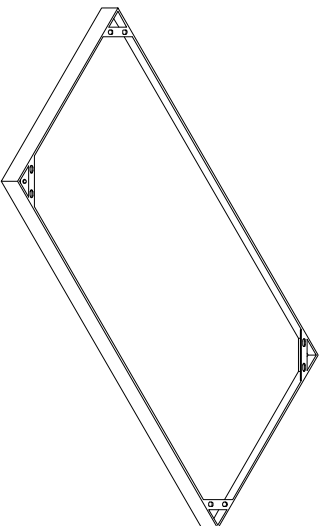

2

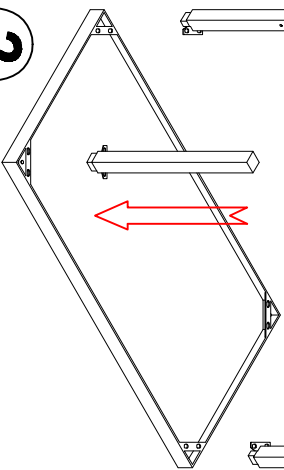

3

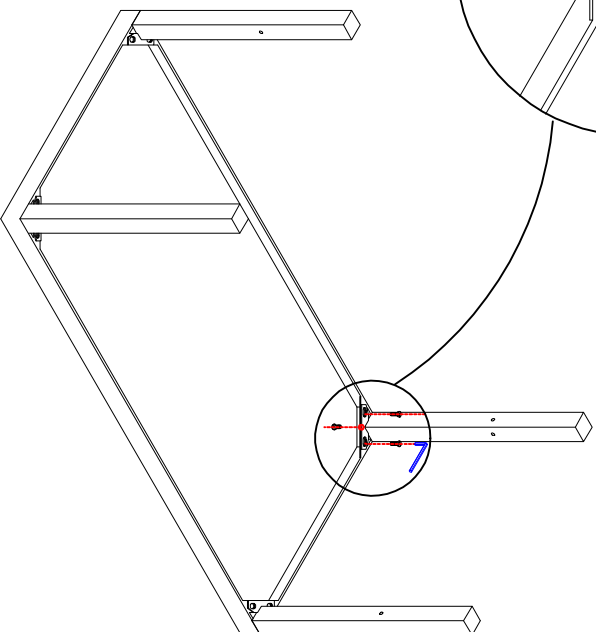

# ASSEMBLY INSTRUCTION

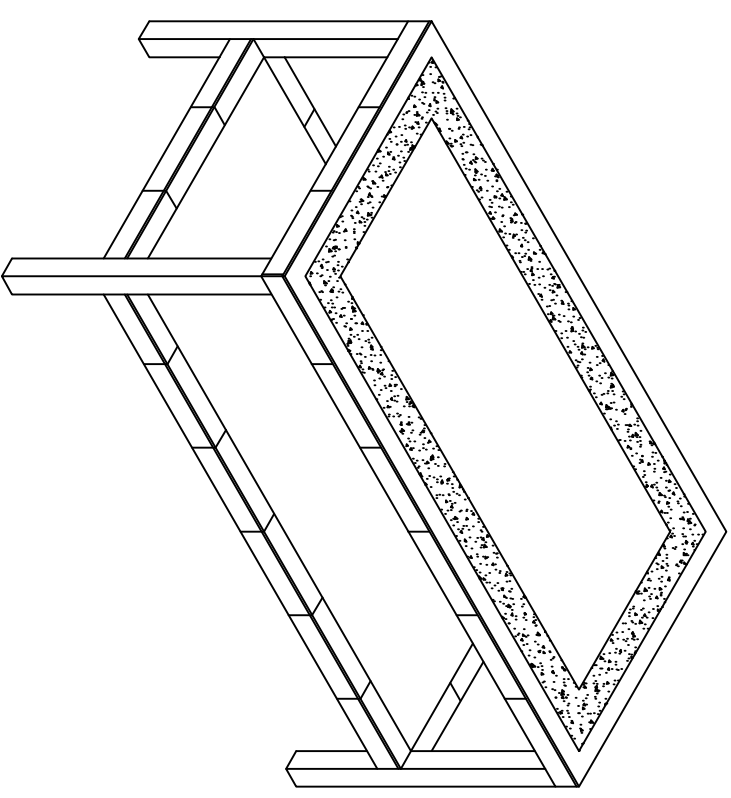
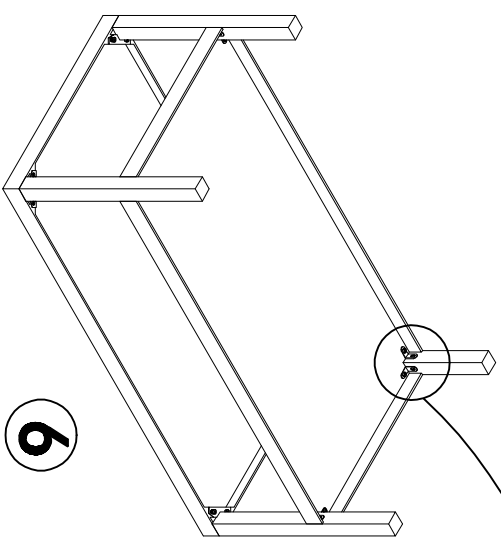
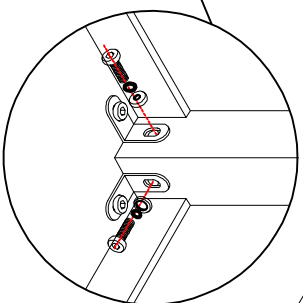
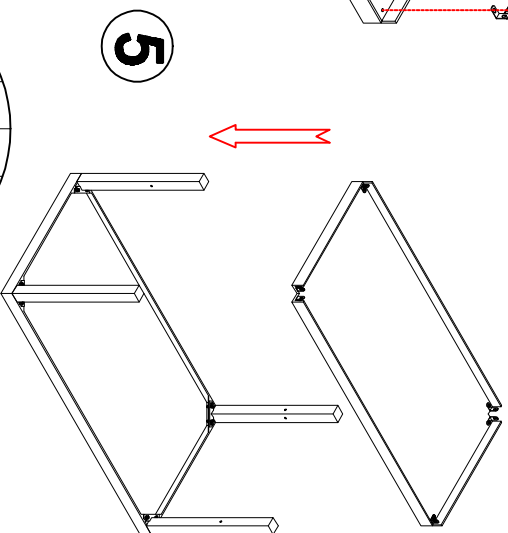
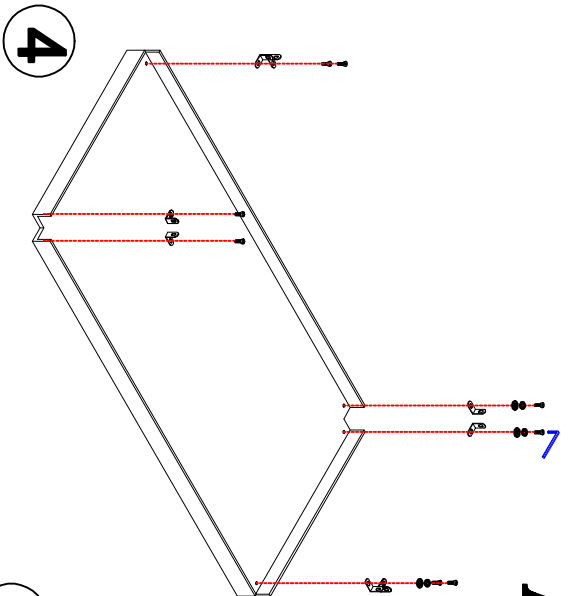

9

4

5