

GeekChef®

Espresso Coffee Maker

User Manual

Model No.: GCF20H

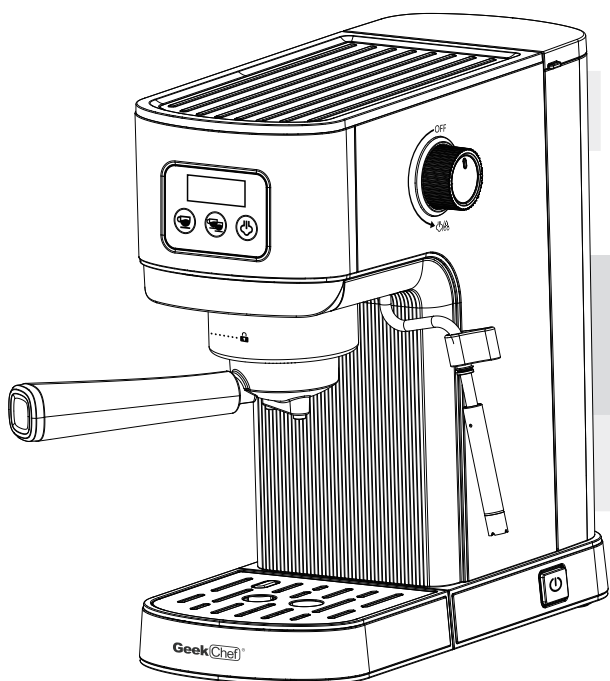

Toll Free: 1-844-801-8880

IMPORTANT: Read the instructions carefully before operating the appliance and keep them for future reference.

TABLE OF CONTENTS

Safety Instructions	2
Product Components	4
How To Use	6
Cleaning And Maintenance	17
Troubleshooting	19
Limited Warranty	21

TECHNICAL SPECIFICATIONS

Model No.:	GCF20H
Power :	1350 W
Voltage:	120V~ 60Hz
Pump Pressure:	20 Bar
Capacity of Water Tank:	1.2L / 40.6 fl.oz

SAFETY INSTRUCTIONS

IMPORTANT SAFETY INSTRUCTIONS

Before using this appliance, the following basic precautions should always be followed:

1. Read all the safety and operating instructions carefully and retain them for future reference.
2. Before using, check that the voltage of the wall outlet corresponds to the voltage marked on the rating plate.
3. To protect against fire, electric shock, and injury **do not** immerse the cord or plug in water or other liquids.
4. The appliance must not be immersed in water.
5. **Do not** place the espresso machine on a hot surface or beside an open flame, or near a hot gas or electric burner, or in a heated oven.
6. **Do not** use appliance for other than intended use.
7. To disconnect, turn to "OFF", then remove the plug from wall outlet. Always hold the plug. But never pull the cord.
8. Be careful not to get burned by the steam and hot water.
9. **Do not** let the espresso machine operates without water.
10. Scalding may occur if the water tank is removed during the brewing cycle.
11. Remove plug from wall outlet before cleaning and when not in use. Allow appliance to cool down completely before taking off or attaching components or before cleaning.
12. **Do not** operate any appliance with a damaged cord or plug or after the appliance malfunctions, or is dropped or damaged in any manner. Return appliance to the nearest authorized service facility or similarly qualified persons for examination, repairs or adjustments in order to avoid a hazard.
13. The use of accessory attachments not recommended by the appliance manufacturer may result in fire, electric shock or injury.
14. Place appliance on a flat surface or table, **do not** hang power cord over the edge of table or counter.
15. Ensure the power cord does not touch the hot surface of the appliance.
16. **Do not** remove the filter holder when in use or when steam or hot water escape from the holder.
17. This appliance is not intended for use by persons (including children) with reduced physical, sensory or mental capabilities, or lack of experience and knowledge, unless they have been given supervision or instruction concerning use of the appliance by a person responsible for their safety.
18. Children should be supervised to ensure that they do not play with the appliance.

SAFETY INSTRUCTIONS

19. This appliance can be used by children aged from 8 years and above and persons with reduced physical, sensory or mental capabilities or lack of experience and knowledge if they have been given supervision or instruction concerning use of the appliance in a safe way and understand the hazards involved. Children shall not play with the appliance.
20. Check the appliance before each use and ensure that the appliance, power cord and plug are not damaged and no parts have come loose.
21. Cleaning and user maintenance shall not be made by children without supervision.
22. This appliance is intended to be used in household and similar applications such as:
 - a) staff-kitchen areas in shops, offices and other working environments;
 - b) farm houses;
 - c) by clients in hotels, motels and other residential type environments;
 - d) bed and breakfast type environments.
23. The heating element surface is subject to residual heat after use.
24. Never touch the hot appliance parts like the steam/hot water outlet, the metal part of the filter holder / portafilter or the filter during or shortly after use. Only touch the heat insulated handles, switches or selectors.
25. Never take the filter holder / portafilter off while the appliance performs a brewing process or steams milk-the appliance is pressurized!
26. Never point the steam/hot water wand towards persons, animals or steam and moisture sensitive furniture! The escaping steam or the water is very hot and could cause scalding!
27. Only cups and tamper may be placed on the cup tray. **Do not** place any other items on the appliance.
28. **Do not** leave the espresso machine unattended when in use. This applies especially when children are nearby.
29. The appliance becomes very hot during use! Allow the appliance to cool down before removing or attaching parts, moving, relocating or cleaning it.
30. After prolonged use, the cup shelf gets so hot that you might scald yourself on it!
31. Oils or lubricants must not be used with this appliance.
32. Pull the plug after every use. Only then, the appliance is fully switched off.
33. **Do not** use outdoors. Keep it away from sources of heat, direct sunlight, humidity (never dip it into any liquid) and sharp edges.

**SAVE THESE INSTRUCTIONS!
HOUSEHOLD USE ONLY**

PRODUCT COMPONENTS

KNOW YOUR ESPRESSO COFFEE MACHINE

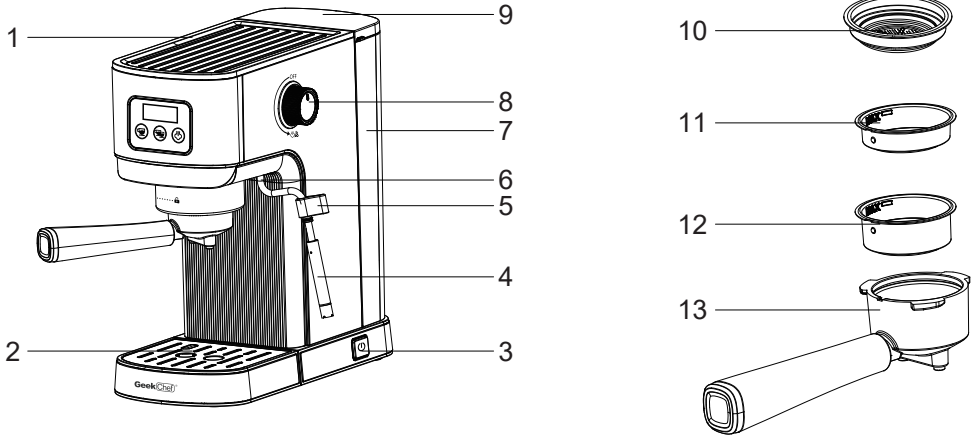

1. Cup Warmer
2. Detachable drip tray
3. Power switch
4. Steam wand cover
5. Steam wand handle
6. Steam wand
7. Water tank
8. Steam control knob
9. Water tank cover
10. E.S.E (Easy Serve Espresso) pod filter
11. Single Shot Filter
12. Double Shot Filter
13. Filter Holder / Portafilter

PRODUCT COMPONENTS

CONTROL PANEL

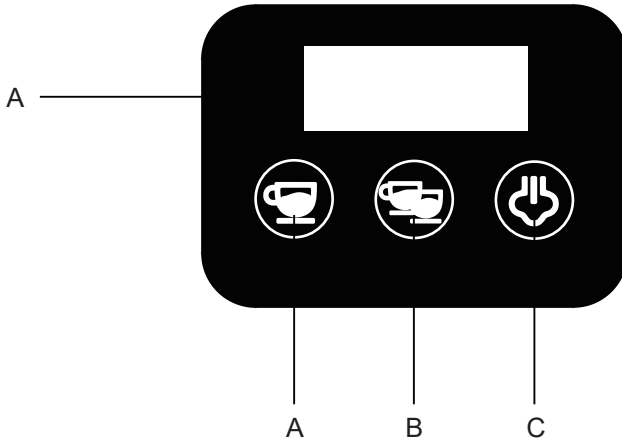

A: LED Display

B: Single-shot Espresso Switch and Indicator

C: Double-shot Espresso Switch and Indicator

D: Steam Switch and Indicator

HOW TO USE

BEFORE THE FIRST USE

CLEANING THE UNIT PRIOR TO THE FIRST USE

1. Carefully remove the unit from the packaging and remove all packaging materials.
2. Remove all accessories from the packaging and from the unit.
3. Remove the water tank.
4. Wash the water tank with the lid, the milk reservoir, the measuring scoop/tamper, the filters and the filter holder in a mixture of mild detergent and water. Rinse and dry each thoroughly and place them back into the unit.
5. Wipe the body of the coffee machine and the drip tray and grid with a soft, damp cloth and dry all parts.
6. Make sure that the milk reservoir is assembled well.



Note: The filter holder and filters are not dishwasher safe.



Warning:

Do not immerse the main body of the appliance or power cord and plug in water or attempt to reach any of its internal parts.

INITIAL USE

1. Turn the steam control knob to the locked/OFF position.



Note:

If the steam control knob turned on before the power on, the machine will alarm, and the single-shot "☕" and double-shot "☕☕" indicators are blinking at the same time. Turn off the steam control knob to remove the alarm.

2. Fill the water tank with cold water up to the "MAX" line of the tank.

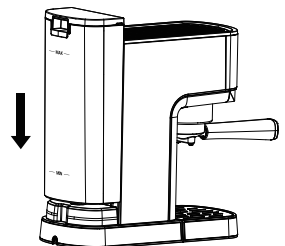

HOW TO USE

3. Insert the filter into the filter holder, making sure to align the filter dimple to the filter holder notch.

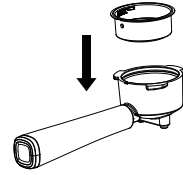

4. Place the filter holder **WITHOUT** coffee grounds into the brew head ensuring it is properly locked. The filter holder must be perpendicular to the machine or slightly tilted towards the right.

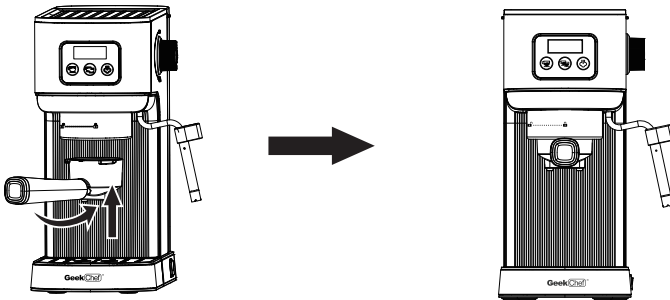

5. Plug the appliance into the appropriate outlet.
6. Press the Power Switch, the display turns on and flashes, the coffee machine starts to preheat automatically. Once the preheating is finished, all the switches will light up continuously. This preheating process takes about 2 minutes.

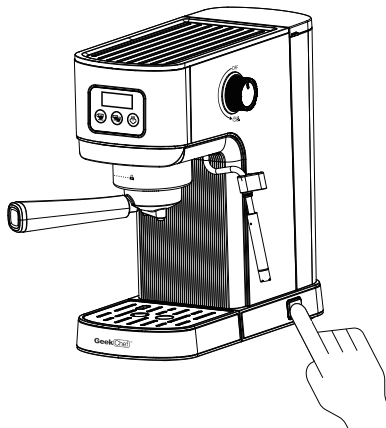

HOW TO USE

- Place an empty cup under the steam wand. Turn the steam control knob to the maximum level slowly, the machine will start to make hot water. Turn off the steam control knob after making hot water for 1~2 minutes. This process allows the water to flow into the empty pump for the first use.

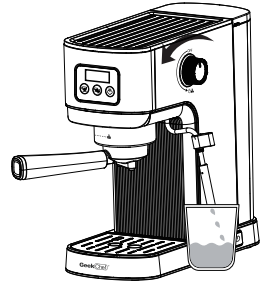

Note: There will be a loud noise and little shake when the machine running first time. It's normal for a 20bar pump. The noise will be weak in the future using.

- Dispose of the water in the cup and place the empty cup under the brewing head, and press the double-shot espresso switch to brew.

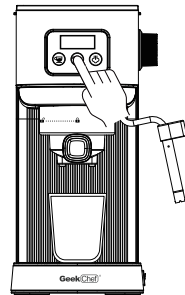

- After the brewing cycle has finished, pour the water out.

Now your espresso coffee machine is ready to use.

PREPARING THE ESPRESSO

Using a cold filter holder, cold filter or cold cup(s) can reduce the extraction temperature enough that it significantly affects the quality of your espresso. We recommend to run a brewing cycle without coffee grounds to preheat them before brewing (**see steps 5-8 of Initial Use**).

HOW TO USE

1. Select the filter to be used as follows:

FOR A SINGLE SHOT – use the filter for a single shot of espresso if using ground coffee, or use the E.S.E. filter if using E.S.E. (Easy Serving Espresso) pods.

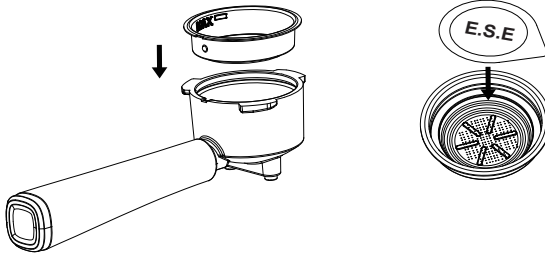

FOR A DOUBLE SHOT OR TWO SINGLE SHOTS – use the filter for a double shot of espresso. By placing two small cups underneath the filter holder, you may prepare two single shots of espresso at once.

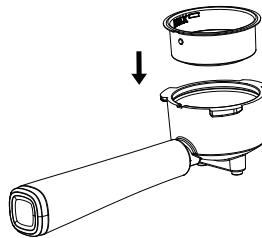

2. Remove the filter holder and fill the filter with coffee grounds using the measure scoop provided with the machine.



We recommend 7-9g for single shot and 13-15g for double shot. The amount will vary depending on your preferences and the coffee grounds you used.

HOW TO USE

- Using the tamping part of the measure scoop, push the coffee grounds downwards as far as the tamper will go to. The coffee grounds must be pressed evenly to obtain a well levelled and flat surface.

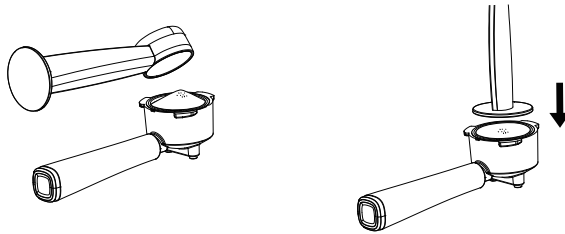

Note: Clean any excess coffee from the rim of the filter holder to ensure proper fit under brew head.

- Insert the filter holder into the brew head, align the filter holder with the UNLOCK "🔓" mark and fits into the groove, and turn it counter-clockwise to the LOCK "🔒" position.

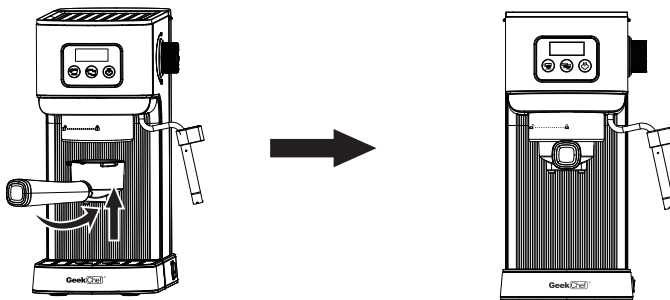

HOW TO USE

MAKING ESPRESSO

1. Place pre-warmed cup(s) underneath the filter holder.
2. Press the single-shot espresso switch "☕" for a single shot, or double-shot espresso switch "☕☕" for a double shot, the machine will start brewing.

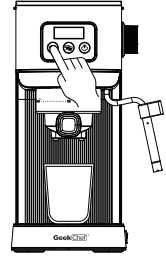

3. The machine will start brewing the espresso according to your selection. The machine will turn off automatically and all indicators will fully illuminate in a solid light, indicating that the cycle has been completed. Your delicious espresso is ready to be enjoyed!



Tips:

The flavor of your coffee will depend on many factors, such as the type of coffee beans, degree of roast, freshness, coarseness or fineness of the grind, dose of ground coffee, and tamping pressure. Experiment by adjusting these factors just one at a time to achieve the taste of your preference.



Note:

There will be noise during the operating process. This is normal for a 20bar pump.



Note:

To brew less coffee than the preset serving, press the Espresso switch at any time to stop the brewing process when the amount of coffee desired is reached.

MAKING HOT WATER

1. Put a big cup or container under the steam wand.
2. When all indicators stay on, turn the steam knob to the maximum position, hot water will come out from steam wand nozzle. In the process of making hot water, the coffee indicators flash slowly.



HOW TO USE

- When the hot water reaches the required amount, turn the steam knob clockwise to the OFF position, and the hot water stops flowing out.



Note:

- The hot water function can also be used to quickly cool down the coffee machine after making steam process.
- You cannot run hot water and extract espresso at the same time.



Warning:

When the machine is working, be careful of the hot parts of the machine. Especially the coffee outlet, filter holder, steam wand and nozzle. When operating, please do not put your hands on the above parts for any reason.

FROTHING MILK

To prepare a traditional cappuccino or latte, we recommend:

- Continue as follows: Using cold (39°F-50°F), fresh whole milk. The density of the frothed milk will depend on the milk fat content.
- Using stainless steel, circular, rounded milk jugs, narrower at the top, with a spout, necessary to make cappuccino decorations.
- Before starting, it is important to slightly move the steam wand outwards in order to insert the jug directly under it and facilitate the movements required to froth the milk correctly.

Continue as follows:

- Use whole, fresh cold milk, and pour 1/3 milk in cup/jug. The volume of milk will increase after frothing.
- Press steam switch "☞", it starts preheating, the steam indicator is flashing, when machine preheating finished the steam indicator lights on.
- Put an empty cup under the steam wand, turn the steam control knob counter-clockwise to the maximum position, release a little water in the steam wand, and turn the steam control knob clockwise to turn off the steam after the steam comes out.

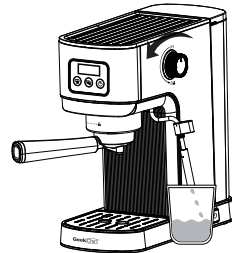

HOW TO USE

4. Put the cup/jug with milk under the steam wand, place the steam nozzle just below the surface of the milk. If it is inserted too deep, the milk will not be frothed; if it is not inserted deep enough, big bubbles will be produced and then disappear immediately.

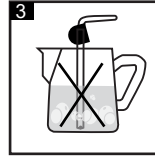
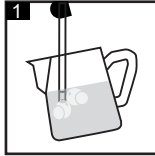

It is important to keep the nozzle not at the center but close to the edge of the jug, with an appropriate angle to produce a stronger vortex.

5. Rotate the steam control knob counterclockwise to let the steam come out

Note:

- The steam pressure increases as the knob is rotated.
- The entire operation should last no longer than 60 seconds.
- To froth the milk correctly, the steam nozzle must always be in contact with the milk and not with the froth. Therefore, as the layer of froth increases, the jug must be slightly raised trying to keep the nozzle in contact with the milk, without touching the bottom of the jug.

6. Once the desired frothing has been achieved, the steam nozzle must be pushed deeper to heat the milk well.

Tips:

It is advisable to always keep a hand on the rounded part of the jug to feel the temperature increase of the unfrothed milk.

7. Once the desired result has been achieved, close the steam control knob, by rotating it clockwise, to stop dispensing steam and remove the jug.

Tips:

To make the froth more compact, it is advisable to lightly tap the jug on a flat surface after frothing.

8. Pour the frothed milk into prepared espresso, now cappuccino is ready.



Warning:

The steam wand may be very hot during and after use. To avoid burns, move it only by placing your fingers on the rubber tip fitted on the steam wand.

HOW TO USE

9. Place an empty cup under the steam wand. Press steam switch "☞" to turn off the steam mode, the coffee indicators "☕" and "☕" will be flashing. Turn on the steam control knob and making hot water for 5s in order to clean the inside of steam wand nozzle. Turn off the steam control knob, ready to make the next cup of coffee.



Note: After frothing milk, please promptly clean the steam wand with a damp cloth to prevent any milk residue from clinging to it.

CUSTOMIZE THE MACHINE SETTINGS

A. MENU SETTING MODE

Before enter the setup menu program, please confirm that the machine is in the ready stage first, and then keep pressing the steam switch "☞" 5 seconds. Until the three switches flash in turn, release the switch, then the machine enters the menu setting mode, you can set the menu program according to your own requirements.

If no operation for 25s, the machine will automatically exit the menu setting mode and restore to standby mode.

B. SETTING THE BREWING TEMPERATURE

When the machine run into **menu setting mode**, please follow the steps below to set the coffee temperature:

1. Press single-shot espresso switch "☕" when single-shot indicator lights up enter into the setting program to set the temperature of the coffee, single-shot indicator flashes, the rest indicators turn off, the display shows the current setting of the coffee temperature: the default temperature is 180°F.
2. Press the single-shot espresso switch "☕" again to select temperature 160°F-170°F-180°F in turn. After selected, the buzzer will beep twice, the setting is completed, display shows selected temperature.
The machine automatically exits the menu setting mode and restore to standby mode.

C. DESCALING REMINDER

The descaling reminder can be set according to the hardness of tap water in different areas. The machine defaults to hard water status. The temperature for descaling is about 120°F.

Recommend descaling cycle (Counting from the first cup of coffee made):



HOW TO USE

Recommend descaling cycle (Counting from the first cup of coffee made):

Soft water	Medium hardness water	Hardness water
after 1500cups	after 1000cups	after 500cups

When the machine run into **menu setting mode**, please follow the steps below to set the descaling time:

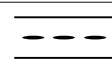

1. Press the double-shot switch "" when double-shot indicator lights up enter into the water hardness setup program. The double-shot switch indicator lights on and the screen displays below:

Soft water	Medium hardness water	Hardness water
		

2. Press the double-shot switch "" to select the water hardness based on your location. After selected, the buzzer will beep twice, the machine automatically exits the menu setting mode and restore to standby mode.

D. SET UP THE BREWING TIME

If you want to brew more or less coffee, please follow the step:

1. Put a cup under the outlet of the coffee.
2. Keep pressing the single-shot "" or double-shot "" espresso switch 3 seconds and the corresponding indicator is flashing. The machine starts making coffee, the screen will show the brewing seconds.
3. When the time reach what you want, press the switch again to confirm the customized brewing time and stop making coffee.
4. The available brewing time range is 15s~75s.



Warning:

- It is necessary to have someone to supervise during making coffee.
- To prevent spills, do not remove the filter holder while the machine is brewing coffee.

HOW TO USE

E. RESTORE FACTORY SETTINGS

Within 15 seconds of powering on the machine, press single-shot espresso switch "☕" and double-shot switch "☕" together for 3 seconds. All indicators will flash 3 times, and the machine will beep 3 times to indicate that the reset is completed.

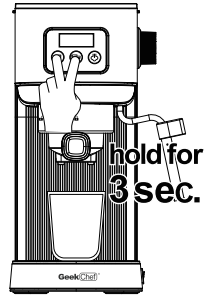

i Note: This operation will reset the menu settings and coffee volume to the default values set at the factory.

DESCALING REMINDER AND DESCALING FUNCTION

1. When the number of cups of coffee made reaches the setting, the two switches ("☕" and "☕") will be steady on and the screen displays E-1. The machine doesn't work, reminder the user that the machine needs to be descaled.
2. Dilute the descaling liquid according to the instructions in the descaling liquid manual and pour it into the water tank. Please put a large container under the coffee outlet, and press the steam switch "☕" for 5 seconds. Until the three switches flash successively.
3. Press the steam switch "☕" again when steam indicator lights up to start descaling, descaling liquid flow from the coffee outlet of the product. Descaling time is about 5 minutes and the screen displays countdown. During the descaling process, press steam switch again to stop process at any time.

i Note: During the descaling process, if the steam wand needs to be cleaned, the descaling liquid can be discharged from the steam wand by turning on the steam control knob, don't forget to put a large container under the steam wand.

4. After descaling is completed, take out the water tank and wash it with clean water, then fill clean water to the maximum water level of the water tank, and rinse the machine again with descaling function. After the descaling process, the machine will resume to normal stage.

CLEANING AND MAINTENANCE

SAFETY FUNCTIONS

Automatic shutdown function

If the product has no operation within 30 minutes, the product will automatically shut down and enter standby state, and all the indicators will be turned off.

If you need to restart the machine, press any switch on the control panel and enter the usable state after the preheating is completed.

Program protection

If NTC is abnormal (such as short circuit, open circuit, etc.), the machine will enter the protection state, and the three indicator lights will flash at the same time, the screen shows **E-3**, which will give an alarm prompt and the machine will not operate. Please contact the service center.

CLEANING AND MAINTENANCE

Regular cleaning and maintenance keep the machine in working condition and ensures perfect coffee flavor, a constant flow of coffee, and excellent milk froth for an extend period. Disconnect the appliance from the mains and let it cool before cleaning it with damp cloth.

CLEANING THE FILTER HOLDER AND THE FILTER

The filters should be kept clean to guarantee perfect results.

1. Remove the filter from the filter holder and wash it with warm water.
2. If you notice a malfunction when brewing coffee, immerse the filter in boiling water for 10 minutes and then rinse with running water.



Warning:

To avoid burns, the filter must only be replaced when the filter holder has cooled down completely.

CLEANING AND MAINTENANCE

CLEANING THE STEAM WAND

After each milk frothing:

1. Clean the steam wand with a damp cloth. To clean it more thoroughly, you can unscrew the nozzle and wash it with running water.
2. Turn on the steam control knob, allowing the steam to escape for one or two seconds to clear the nozzle hole.
3. Clean the nozzle with wet sponge.

CLEANING THE GRID AND DRIP TRAY

Remove the drip tray and the grid and wash them with water.

Do not use abrasive cleaning tools.

CLEANING THE WATER TANK

To clean the Water tank often. Remove the Water tank and wash it with fresh water.



Warning:

To avoid burns, the tank should be cleaned only when the machine is turned off. The drain hose may reach high temperatures during operation.

CLEANING THE BREW UNIT

Regularly remove any residual coffee grounds from the Brew unit using a brush and wash with hot water following the steps below.

1. Do not insert the Filter holder.
2. Place an empty cup under the Brew unit.
3. Press the coffee switch and fill the cup with water.
4. Wait the machine stop automatically, or press the coffee switch again to stop.

TROUBLESHOOTING

PROBLEM	CAUSE / RESULT	SOLUTION
E-1	Needs to descaling.	Follow the instructions for descaling.
E-2	The inner temperature is too high.	Let the machine cold down or turn on the knob to release the hot water to cool.
E-3	NTC is abnormal.	Please contact the service center.
The coffee machine is not flowing coffee from the outlet.	The water tank is empty.	Pour water to the water tank.
	The filter is clogged.	The filter is clogged.
	The coffee outlet id clogged.	Clean the coffee outlet.
	The water tank is not properly installed.	Properly installed the water tank.
Coffee is overflowing from the gap in the funnel.	There are foreign objects in the seal ring.	Clean the seal ring.
	The coffee grounds are too fine.	Replace with slightly coarser coffee grounds.
	The coffee grounds are packed too tightly.	Reduce the pressure.
	There are coffee grounds around the filter mouth.	Clean the filter mouth before screwing it into the machine.
	The sealing ring is aging.	Please contact the service center.
Coffee is cold	The indicator light is not constantly	Operation after the indicator light is constantly on.
	The coffee machine is not preheated.	Preheat before use.
	The coffee cup is not preheated.	Preheat the cup before use.
The pump is making excessive noise.	The water tank is empty.	Pour water to the water tank.
	The water tank is not properly installed.	Properly installed the water tank.
The coffee is too weak.	The coffee grounds aren't properly tamped.	Tamp the coffee grounds again.
	Not enough coffee grounds.	Add coffee grounds.
	The coffee grounds are too coarse.	Use espresso machine-specific coffee grounds.

TROUBLESHOOTING

PROBLEM	CAUSE / RESULT	SOLUTION
The coffee color is too dark.	The coffee grounds are tamped too tightly.	Reduce the tamping pressure.
	Too much coffee grounds.	Reduce the coffee grounds.
	The filter is clogged.	The filter is clogged.
	The coffee grounds are too fine.	Use the right coffee grounds.
	The coffee outlet is clogged.	Clean the coffee outlet.
The coffee handle cannot rotate to the locked position.	Too much coffee grounds.	Reduce the coffee grounds.
	The coffee handle cannot rotate into place even without coffee grounds.	Please contact the service center.
The coffee making is normal, but cannot make the milk foam.	Steam wand sleeve is clogged.	Use a paperclip to insert into the steam wand from the end to unclog it.
		Add edible vinegar to the water tank.



DO NOT TAKE APART THE APPLIANCE. CONTACT AN AUTHORIZED SERVICE FACILITY. DISASSEMBLING THE MACHINE BY YOURSELF WILL VOID THE WARRANTY.

CORRECT DISPOSAL OF THIS PRODUCT



This marking indicates that this product should not be disposed with other household wastes throughout the USA. To prevent possible harm to the environment or human health from uncontrolled waste disposal, recycle it responsibly to promote the sustainable reuse of material resources. To return your used device, please use the return and collection systems or contact the retailer where the product was purchased. They can take this product for environmentally safe recycling.

LIMITED WARRANTY

LIMITED WARRANTY

Geek Technology Ltd. warrants to the original consumer or purchaser this Geek Chef Espresso Coffee Maker is free from defects in material or workmanship for a period of One (1) year from the date of purchase. If any such defect is discovered within the warranty period, Geek Technology Ltd. at its discretion, will repair or replace the Product at no cost. This limited warranty is good only to the original purchaser of the product and effective only when used in United States.

For warranty or repair service: Call 1-844-801-8880 and choose the appropriate prompt, or email info@geektechnology.com. Please have your Product's model number, date code (on rating label), your name, address, city, state, zip code and phone number ready.

NO OTHER WARRANTY IS APPLICABLE TO THIS PRODUCT. THIS WARRANTY IS IN LIEU OF ANY OTHER WARRANTY, EXPRESS OR IMPLIED. INCLUDING WITHOUT LIMITATION, ANY WARRANTY OF MERCHANTABILITY OR FITNESS FOR A PARTICULAR PURPOSE. TO THE EXTENT ANY IMPLIED WARRANTY IS REQUIRED BY LAW. IT IS LIMITED IN DURATION TO THE EXPRESS WARRANTY PERIOD ABOVE. NEITHER THE MANUFACTURER NOR ITS U.S. DISTRIBUTOR SHALL BE LIABLE FOR ANY INCIDENTAL, CONSEQUENTIAL, INDIRECT, SPECIAL, OR PUNITIVE DAMAGES OF ANY NATURE. INCLUDING WITHOUT LIMITATION. LOST REVENUES OR PROFITS, OR ANY OTHER DAMAGE WHETHER BASED IN CONTRACT, TORT, OR OTHERWISE, SOME STATES AND/OR TERRITORIES DO NOT ALLOW THE EXCLUSION OR LIMITATION OF INCIDENTAL OR CONSEQUENTIAL DAMAGES OR LIMITATIONS ON HOW LONG AN IMPLIED WARRANTY LASTS. SO THE ABOVE EXCLUSION OR LIMITATION MAY NOT APPLY TO YOU. THIS WARRANTY GIVES YOU, THE ORIGINAL PURCHASER, SPECIFIC LEGAL RIGHTS AND YOU MAY ALSO HAVE OTHER RIGHTS THAT VARY FROM STATE TO STATE OR TERRITORY TO TERRITORY.

THIS LIMITED WARRANTY DOES NOT APPLY TO :

1. Failure of product to perform during power failures and interruptions or inadequate electrical service.
2. Damage caused by transportation or handling.
3. Damage caused to the product by accident, vermin, lightning, winds, fire, floods, or acts of God.
4. Damage resulting from accident, alteration, misuse, abuse, or improper installation, repair, or maintenance. Improper use includes using an external device that alters or converts the voltage or frequency of electricity.
5. Any unauthorized product modification, repair by unauthorized repair center, or use of non-approved replacement parts.
6. Abnormal cleaning and maintenance as described in the user's manual.
7. Use of accessories or components that are not compatible with this product.



GeekChef®

Bring The Future Home

Geek Technology Ltd.
1275 Bloomfield Ave
Fairfield, NJ 07004
Toll Free 1-844-801-8880