

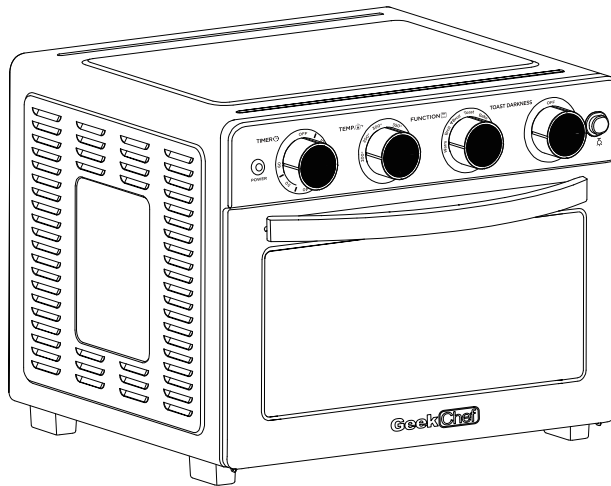

Air Fryer Oven

User Manual

Model No.: GTO26



Toll Free: 1-844-801-8880

IMPORTANT: Read the instructions carefully before operating the appliance and keep them for future reference.

TABLE OF CONTENTS

Safety Instructions	2
Product Components	5
How To Use	6
Cleaning And Maintenance	12
Troubleshooting	13
Limited Warranty	14

TECHNICAL SPECIFICATIONS

Model No.:	GTO26
Rated Voltage :	120V~60Hz
Rated Power :	1700W
Oven Capacity :	26QT
Product Dimension :	16.1*15.2*13.8 (inch)

SAFETY INSTRUCTIONS

IMPORTANT SAFETY INSTRUCTIONS

When using an electrical appliance, basic safety precautions should always be followed, including the following:

1. Read all instructions.
2. **UNPLUG FROM OUTLET WHEN NOT IN USE AND BEFORE CLEANING.**
Allow to cool before cleaning or handling, putting on or taking off parts.
3. **Do not** touch hot surfaces. Use handles or knobs.
4. To protect against electrical shock, **do not** place any part of the Air Fryer Countertop Oven in water or other liquids. See instructions for Cleaning and Maintenance.
5. This appliance should not be used by or near children or individuals with certain disabilities.
6. **Do not** operate any appliance with a damaged cord or plug, or after the appliance has mal-functioned or has been dropped or damaged in any way or is not operating properly. Return the Air Fryer Countertop Oven to the store or retailer where purchased for examination or repair, or replacement.
7. The use of accessory attachments not recommended may cause injury.
8. **Do not** use outdoors.
9. **Do not** let cord hang over the edge of the table or countertop, where it could be pulled on inadvertently by children or pets, or touch hot surfaces, which could damage the cord.
10. **Do not** place this Air Fryer Countertop Oven on or near a hot gas or electric burner or in a heated oven.
11. **Do not** use this Air Fryer Countertop Oven for anything other than its intended purpose.
12. Extreme caution should be exercised when using containers constructed of materials other than metal or glass in the oven.
13. To avoid burns, use extreme caution when removing Air Fryer Countertop Oven accessories or disposing of hot grease.
14. When not in use, always unplug the unit. **Do not** store any materials other than manufacturer's recommended ovenproof accessories in this Air Fryer Countertop Oven.
15. **Do not** place any of the following materials in the Air Fryer Counter top Oven: paper, cardboard, plastic and similar products.

SAFETY INSTRUCTIONS

16. **Do not** cover Crumb Tray or any part of the oven with metal foil. This will cause overheating of the oven.
17. Oversize foods, metal foil packages and utensils must not be inserted in the Air Fryer Countertop Oven, as they may involve a risk of fire or electric shock.
18. A fire may occur if the Air fryer oven is covered or touching flammable materials such as curtains, draperies or walls, when in operation. **Do not** store any items on top of the appliance when in operation. **Do not** operate under wall cabinets.
19. **Do not** clean with metal scouring pads. Pieces can break off the pad and touch electrical parts, involving a risk of electric shock.
20. **Do not** attempt to dislodge food when the Air Fryer Countertop Oven is plugged into the electrical outlet.
21. Warning: To avoid possibility of fire, NEVER leave Air Fryer Counter top Oven unattended during use.
22. **Do not** rest cooking utensils or baking dishes on glass door.
23. **Do not** operate your appliance in an appliance garage or under a wall cabinet. When storing in an appliance garage, always unplug the unit from the electrical outlet. Not doing so could create a risk of fire, especially if the appliance touches the walls of the garage or the door touches the unit as it closes.
24. Extreme caution must be used when moving an appliance containing hot oil or other hot liquids.
25. To disconnect, turn the control knobs to "OFF" position, then remove plug from the wall outlet.

SAVE THESE INSTRUCTIONS

Please read and keep these instructions handy. These instructions will help you use your Air Fryer Countertop Oven to its fullest so that you will achieve consistent, professional results.

SPECIAL CORD SET INSTRUCTIONS

A short power-supply cord is provided to reduce the risks resulting from becoming entangled in or tripping over a longer cord. Extension cords are available and may be used if care is exercised in their use. If an extension cord is used,

SAFETY INSTRUCTIONS

1. The marked electrical rating of the extension cord must be at least as great as the electrical rating of the appliance.
2. The longer cord should be arranged so that it will not drape over the countertop or tabletop, where it can be tripped over unintentionally or pulled on by children.

NOTICE

This appliance has a polarized plug (one blade is wider than the other). As a safety feature, this plug will fit in a polarized outlet only one way. If the plug does not fit fully in the outlet, reverse the plug. If it still does not fit, contact a qualified electrician. Do not attempt to defeat this safety feature.

FOR HOUSEHOLD USE ONLY
NOT INTENDED FOR COMMERCIAL USE

PRODUCT COMPONENTS

PRODUCT COMPONENTS

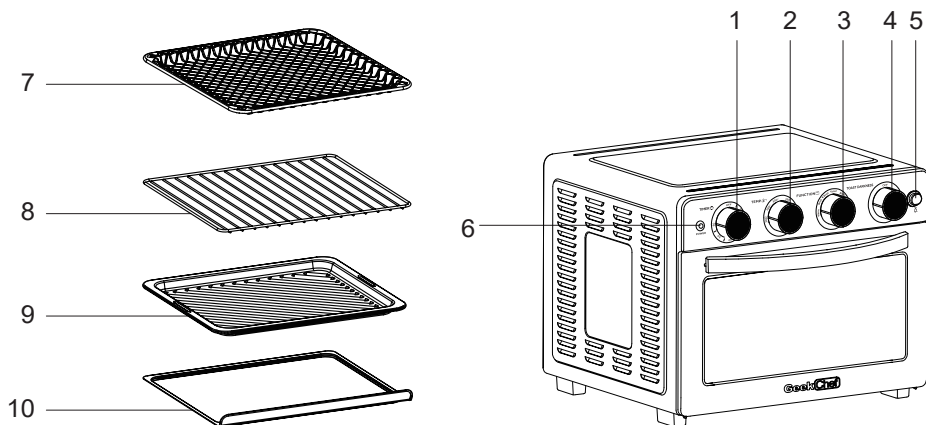

- | | |
|----------------------------|---------------------|
| 1. Timer Dial | 6. Power Indicator |
| 2. Temperature Dial | 7. Air Fryer Basket |
| 3. Function Dial | 8. Oven Rack |
| 4. Toast Darkness Function | 9. Baking Pan |
| 5. Oven Light Button | 10. Crumb Tray |

Product Features



1. Timer Dial

Use to set the desired time for all functions except Toast. Setting the Oven timer, powers the unit on and begins the cooking cycle. When the Timer runs out, the unit will power off.

2. Temperature Dial

Use to set the desired temperature.

3. Function Dial

Use to select the cooking function-Warm, Broil,  Broil(Convection), Toast, Bake,  Bake (Convection), Air Fry.

4. Toast Darkness Function

Use to desired toast shade from light to dark. Setting the toast darkness level, powers the unit on and begins the toasting cycle. When cycle is Complete, the unit will power off.

HOW TO USE

5. Oven Light Button

Push the button to turn on the interior oven light. The light will not work if the power is off.

6. Power Indicator

Indicator light will turn on and remain lit when oven is in use.

7. Air Fryer Basket

The Air Fryer Basket is grated to allow air to pass through the basket for even cooking. The Air Fryer Basket Should be placed in the middle rack position unless a recipe states Otherwise.

8. Oven Rack

The Oven rack can be used in three rack positions, bottom, middle, And top. See “Oven Rack/Pan position” section in the manual. Generally, the top position should be used for Broil,the middle for Air Fry and Toast, and the bottom for Warm and Bake.Always reference recipe instructions for proper position.

9. Baking Pan

The Baking Pan is can be placed in any of the three rack positions.

10. Crumb Tray

Always ensure that the removable Crumb Tray is placed underneath the Bottom heating elements whenever the oven is being used.

Control Panel

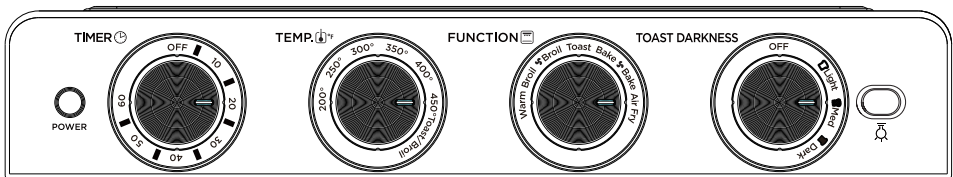

HOW TO USE

Before First Use

1. Remove all packaging materials, stickers and labels.
2. Clean all the accessories with hot water, cleaning agent and a non-abrasive sponge.
3. Wipe the inside and outside of the appliance with a damp cloth.



Note

- Objects should not be stored on the top of the oven.
- The exterior housing will get very hot when in use, keep out of reach of children.

Oven Rack/Pan Positions

Oven have 3 rack/pan positions: Position 1(bottom) , Position 2(middle), Position 3(top). Usually suggested put over rack or pan in position 2(middle) For best cooking result.

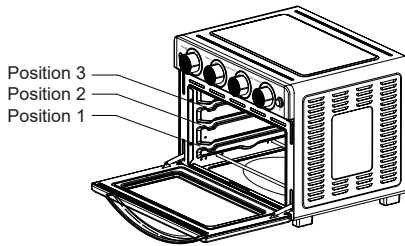

Operation Instructions for Accessories

1. Place your Air Fryer Oven on a flat surface

Before using your Air Fryer Oven, move it 4 inches away from the wall or from any objects on the countertop. Do not use on heat-sensitive surfaces.

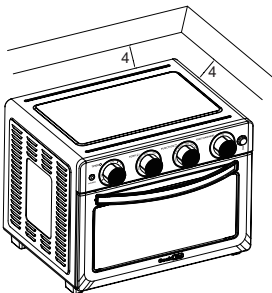

HOW TO USE

2. Crumb Tray

Opening front door, put crumb tray into the unit according to the directions shown in the picture below:

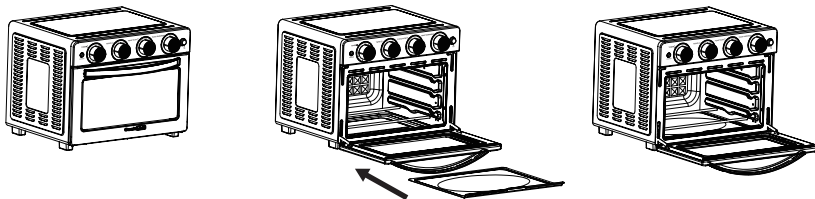

Note

- Choose proper accessories for different cooking purpose.
- Please use oven mitts to take out the crumb tray, baking pan, wire rack and air fry basket etc. after cooking finished.
- Please always keep the crumb tray on the bottom of the cooking chamber for gathering oil from the fried food.
- Objects should not be stored on the top of the oven.
- The exterior housing will get very hot when in use, keep out of reach of children.

3. Baking Pan

Put the food into the baking pan and put it into the cooking chamber, and then close the door.

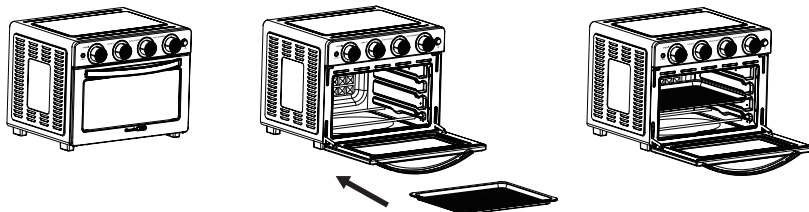

HOW TO USE

4. Oven Rack

Insert the oven rack into the unit according to the directions shown in the picture below:

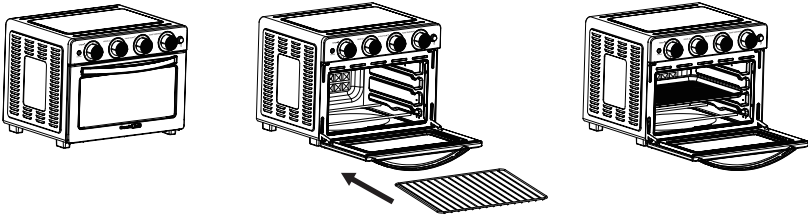

5. Air Fry Basket

Insert the wire rack into the unit, then put the food into the air fry basket and put it on wire rack.

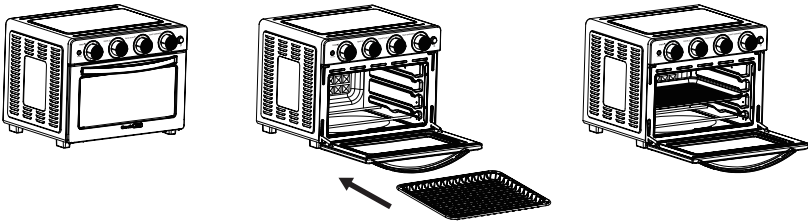

Note

- Choose proper accessories for different cooking purpose.
- Please use oven mitts to take out the crumb tray, baking pan, wire rack and air fry basket etc. after cooking finished.
- Please always keep the crumb tray on the bottom of the cooking chamber for gathering oil from the fried food.

HOW TO USE

Operations

Unwind the power cord. Check that Crumb Tray is in place and that there is nothing in the oven. Plug power cord into the wall outlet.

Broil or ↻ Broil(Convection)

Set the Function Dial to Broil or Broil. Set Temperature Dial to Toast/Broil(450 °F). Then turn the Timer Dial to the desired cooking time to turn on the oven and begin broiling. The power light will illuminate. The timer will ring once.

When the cycle is complete and the oven will power off when the time expires.

To stop broiling, turn the Timer Dial to the OFF position.

Broiling Tips:

Never use glass oven dishes to broil.

Be sure to keep an eye on food - items can get dark quickly while broiling.

Bake or ↻ Bake(Convection)

Set the function to Bake or Bake. Set the Temperature Dial to desired Temperature. Then turn the Timer Dial to the desired cooking time to start the Oven and begin baking (It is recommended to preheat oven for 5 minutes prior to baking. Incorporate this into the total baking time). The power light will turn On. The timer will ring once when the cycle is complete and the oven will Power off when the time expires. Place the pan in position 2 for baking. For Chicken or other large items, the pan can be in Position 1. To stop operation, turn the Timer Dial to the OFF position.

Warm

Set the temperature Dial to 200 °F set the Function Dial to Warm. Then turn the Timer Dial to the desired warming time to start the oven and begin warming. The power light will illuminate. The timer will ring once when the cycle is complete and the oven will power off when the time expires. To stop warming, turn the Timer Dial to the OFF position.

HOW TO USE

Toast

Fit Oven Rack into position 2. If toasting two items, center them in the middle of the Oven Rack. Four items should be evenly spaced - two in front, two in back. Six items should be evenly spaced - three in front, three in back. Set the Function Dial to toast. Set the Temperature Dial to Toast/Broil. Turn The Toast Darkness Dial to desired shade setting from light to dark within the marked settings to turn on the oven and begin toasting. The oven power light will illuminate. When completed, the timer will ring and turn off. To stop toasting, turn the Toast Darkness Dial to the OFF position.

Air Fry

Air Fry in rack Position 2. Set the Function Dial to Air Fry. Set Temperature Dial to desired temperature. Then turn the Timer Dial to the desired cooking time to turn on the oven and begin Air Frying. The oven power light will illuminate. The timer will ring once when the cycle is complete and the oven will power off when the time expires. To stop Air Frying, turn the Timer Dial to the OFF position.

Cooking Chart

The chart below lists recommended cooking times and portions for various types of foods that can be used in this Air Fryer Countertop Oven.

Food	Function Setting	Recommended Amount	Cooking Time	Recommended Accessories	Rack Position
French Fry	Air Fry	1.1pounds(500g)	20 mins.	Air Fry Basket	Middle
Fish	Air Fry	1.8pounds(800g)	25 mins.	Bake Tray	Middle
Chicken Leg	Air Fry	2.2pounds(1000g)	20 mins.	Air Fry Basket	Middle
Pizza	Bake	8 inch	10 mins.	Oven Rack	Middle
Bread	Toast	6 slices	Toast Darkness Light/Med/Dark	Oven Rack	Middle

CLEANING AND MAINTENANCE

1. Unplug your Air Fryer Oven and allow it to completely cool before cleaning. Do not use abrasive cleaners, as they will damage the finish. Simply wipe the exterior with a clean, damp cloth and dry thoroughly. Apply the cleaning agent to a cloth, not directly onto the Air Fryer Oven. Do not use excess pressure when cleaning the area of the control panel as it could cause the text to be removed over time.
2. To clean the interior walls and bottom of the oven (remove the Crumb Tray first) use a damp soapy cloth or sponge. Never use harsh abrasives or corrosive products including oven cleaner sprays. These could damage the oven surface. Never use steel wool pads on the Air Fryer Oven or accessories.
3. The Oven Rack, Baking/Drip Pan, Air Fryer Basket and Crumb Tray should be hand-washed in hot, sudsy water or use a nylon scouring pad or nylon brush. These parts are not dishwasher safe.
4. Always clean the Crumb Tray after each use. Excess food particles could cause smoking and will be hard to remove from tray. To remove baked-on grease or burnt food particles you can soak the Crumb Tray in hot, sudsy water or use nonabrasive cleaners. Never operate the oven without the Crumb Tray in place.
5. The top interior of the Air Fryer Oven should be cleaned to remove excess grease that may accumulate after cooking greasy foods. Doing so will prevent smoking in the oven during subsequent uses.

TROUBLESHOOTING

PROBLEM		PROBABLE CAUSE
The oven will not turn on.	1	Make sure the oven is plugged in.
	2	Turn on the TIMER DIAL.
Foods are not completely cooked.	1	Increase cooking TEMP °F or time.
Foods are over cooked or burned.	1	Decrease cooking TEMP °F or time.
	2	Make sure foods are not too large to touch the heating elements.
Foods are cooked unevenly.	1	Preheat the oven.
	2	Make sure foods are not too closely placed onto a tray, rack or other container.
White smoke is coming out from the oven.	1	The oven may cause a little white smoke when it be first used. This is normal.
	2	When the oven is cooking, excess oil or fatty foods may cause white smoke. Make sure the inside of the oven is cleaned properly and not greasy.
Black smoke is coming out from the oven.	1	Immediately turn off the oven and then unplug it. Cool down the oven to room TEMP °F. Wait for smoke to clear before opening the oven door or pulling out the tray, basket or rack.

LIMITED WARRANTY

LIMITED WARRANTY

Geek Technology Co., Ltd. warrants to the original consumer or purchaser this Geek Chef Air Fryer Oven is free from defects in material or workmanship for a period of One (1) year from the date of purchase. If any such defect is discovered within the warranty period, Geek Technology Co., Ltd. at its discretion, will repair or replace the Product at no cost. This limited warranty is good only to the original purchaser of the product and effective only when used in United States.

For warranty or repair service: Call 1-844-801-8880 and choose the appropriate prompt, or email care@geektechnology.com. Please have your Product's model number, date code (on rating label), your name, address, city, state, zip code and phone number ready.

NO OTHER WARRANTY IS APPLICABLE TO THIS PRODUCT. THIS WARRANTY IS IN LIEU OF ANY OTHER WARRANTY, EXPRESS OR IMPLIED. INCLUDING WITHOUT LIMITATION, ANY WARRANTY OF MERCHANTABILITY OR FITNESS FOR A PARTICULAR PURPOSE. TO THE EXTENT ANY IMPLIED WARRANTY IS REQUIRED BY LAW. IT IS LIMITED IN DURATION TO THE EXPRESS WARRANTY PERIOD ABOVE. NEITHER THE MANUFACTURER NOR ITS U.S. DISTRIBUTOR SHALL BE LIABLE FOR ANY INCIDENTAL, CONSEQUENTIAL, INDIRECT, SPECIAL, OR PUNITIVE DAMAGES OF ANY NATURE. INCLUDING WITHOUT LIMITATION. LOST REVENUES OR PROFITS, OR ANY OTHER DAMAGE WHETHER BASED IN CONTRACT, TORT, OR OTHERWISE, SOME STATES AND/OR TERRITORIES DO NOT ALLOW THE EXCLUSION OR LIMITATION OF INCIDENTAL OR CONSEQUENTIAL DAMAGES OR LIMITATIONS ON HOW LONG AN IMPLIED WARRANTY LASTS. SO THE ABOVE EXCLUSION OR LIMITATION MAY NOT APPLY TO YOU. THIS WARRANTY GIVES YOU, THE ORIGINAL PURCHASER, SPECIFIC LEGAL RIGHTS AND YOU MAY ALSO HAVE OTHER RIGHTS THAT VARY FROM STATE TO STATE OR TERRITORY TO TERRITORY.

THIS LIMITED WARRANTY DOES NOT APPLY TO :

1. Failure of product to perform during power failures and interruptions or inadequate electrical service.
2. Damage caused by transportation or handling.
3. Damage caused to the product by accident, vermin, lightning, winds, fire, floods, or acts of God.
4. Damage resulting from accident, alteration, misuse, abuse, or improper installation, repair, or maintenance. Improper use includes using an external device that alters or converts the voltage or frequency of electricity.
5. Any unauthorized product modification, repair by unauthorized repair center, or use of non-approved replacement parts.
6. Abnormal cleaning and maintenance as described in the user's manual.
7. Use of accessories or components that are not compatible with this product.



Geek Technology Co., Ltd.
120 US Route 46,
Parsippany, NJ 07054
Toll Free 1-844-801-8880

Version Update: --2022.11