

# GeekChef®

## Espresso Coffee Maker

---

### User Manual

Model No.: GCF20E

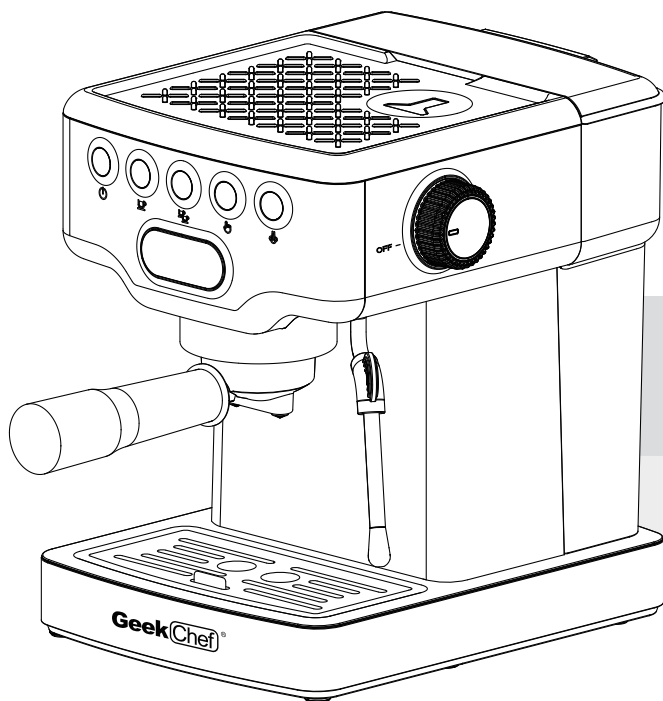

Toll Free: 1-844-801-8880

**IMPORTANT:** Read the instructions carefully before operating the appliance and keep them for future reference.

# TABLE OF CONTENTS

---

<b>Safety Instructions</b>	<b>2</b>
<b>Product Components</b>	<b>4</b>
<b>How To Use</b>	<b>8</b>
<b>Cleaning And Maintenance</b>	<b>14</b>
<b>Troubleshooting</b>	<b>16</b>
<b>Limited Warranty</b>	<b>18</b>

## TECHNICAL SPECIFICATIONS

---

Model No.:	GCF20E
Power :	1350 W
Voltage:	120 V
Pump Pressure:	20 Bar
Capacity of Water Tank:	1.8 L/60.9 fl.oz

# SAFETY INSTRUCTIONS

---

## IMPORTANT SAFETY INSTRUCTIONS

1. Read all the safety and operating instructions carefully and retain them for future reference.
2. The appliance is designed exclusively for private use and for the envisaged purpose. This appliance is not fit for commercial use.
3. **Don't** use it outdoors. Keep it away from sources of heat, direct sunlight, humidity (never dip it into any liquid) and sharp edges. **Do not** use the appliance with wet hands. If the appliance is humid or wet, unplug it immediately.
4. When cleaning or putting it away, switch off the appliance and always pull out the plug from the socket (pull the plug itself, not the lead) if the appliance is not being used and remove the attached accessories.
5. **Do not** operate the machine without supervision. Never leave the operating machine unattended. If you leave the room you should always turn the device off. Remove the plug from the socket.
6. The device and the mains lead have to be checked regularly for signs of damage. If damage is found the device must not be used.
7. **Do not** try to repair the appliance on your own. Always contact an authorized technician. To avoid the exposure to danger, always have faulty cable be replaced only by the manufacturer, by our customer service or by qualified person and with a cable for the same type.
8. In order to ensure your children's safety, please keep all packaging (plastic bags, boxes, polystyrene etc.) out of their reach.
9. This device is not intended to be used by individuals (including children) who have restricted physical, sensory or mental abilities and/or insufficient knowledge and/or experience, unless they are supervised by an individual who is responsible for their safety or and have received instructions on how to use the device. Children should be supervised at all times in order to ensure that they **do not** play with device.
10. Place the coffee machine on a firm and flat surface. Position it so that it cannot tip over.
11. Never apply accessory attachments which are not specified for this appliance.
12. **Do not** touch hot parts of appliance.
13. **Do not** place the device directly next to a gas or electric cooker or any other source of heat.
14. The water tank must only be filled with cold water!

# SAFETY INSTRUCTIONS

---

15. The appliance is only to be used as described in the user manual.
16. **Do not** use the appliance for any commercial purposes.
17. Any other use is not intended and can result in damages or personal injuries.
18. The manufacturer assumes no liability for damages caused by improper use.
19. Do not operate any appliance with a damaged cord or plug or after the appliance malfunctions, or has been damaged in any manner. Return appliance to the nearest authorized service facility for examination, repair or adjustment.
20. Place appliance on flat surface or table, do not hang its power cord over the edge of table or counter.
21. Be careful to ensure that the power cable does not become trapped and does not rub against sharp edges.
22. To protect against fire, electric shock and injury to persons, do not immerse appliance or power cord into water or any other liquids.
23. Once the fault, defect or machine drop caused by suspicious defect, unplug the power plug immediately, do not operate on the problem machine.
24. Do not immerse the machine into water.

**SAVE THESE INSTRUCTIONS!  
HOUSEHOLD USE ONLY**

# PRODUCT COMPONENTS

## KNOW YOUR COFFEE MAKER

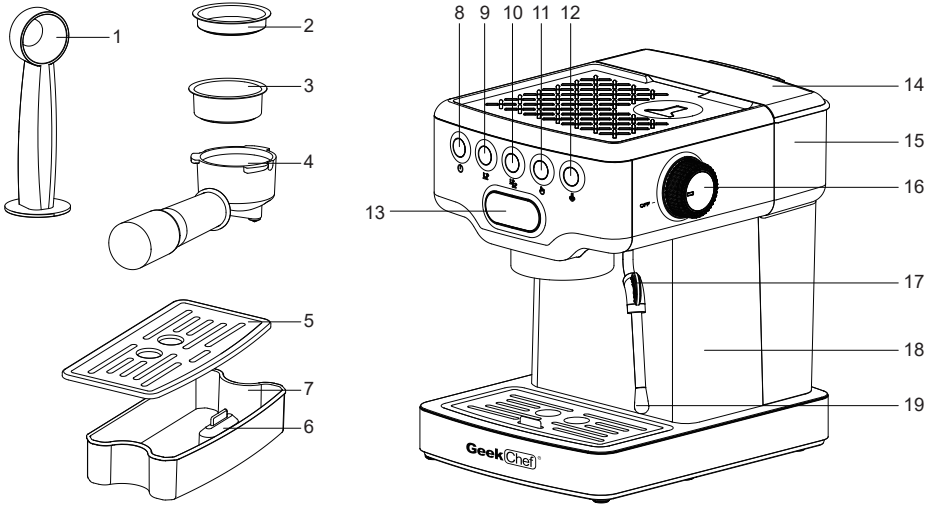

1. Coffee spoon
2. Single-cup coffee filter
3. Double-cup coffee filter
4. Filter holder
5. Drip tray cover
6. Buoy
7. Drip tray
8. Power switch
9. Single-cup coffee switch
10. Double-cup coffee switch
11. Manual coffee switch
12. Steam switch
13. Display screen
14. Water tank cover
15. Water tank
16. Steam knob
17. Steam pipe handle
18. Main body
19. Steam pipe and nozzle



**Note:** The machine must use ground coffee to make coffee and coffee drinks (e.g. Cappuccino, Latte and so on).

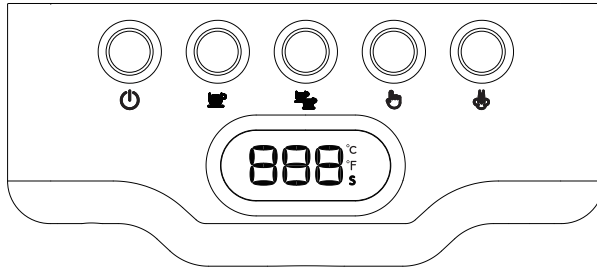

# PRODUCT COMPONENTS

## CONTROL PANEL



### 1. " " Power button

Plug in the unit, the power button indicator turns on.

Press the power button once to start preheating, the "  " "  " "  " button indicators are flashing. After preheating, the above indicators keep on, the machine is in standby mode. Press power button again to turn off.

### 2. " " Single-cup coffee button

Press it to start brewing single cup volume espresso coffee after preheating. The coffee machine will stop automatically when coffee brewing finished.

During coffee brewing, you can press the coffee button again to stop the operation if you like.

### 3. " " Double-cup coffee button

Press it to start brewing double cup volume espresso coffee after preheating.

The coffee machine will stop automatically when coffee brewing finished.

During coffee brewing, you can press the coffee button again to stop the operation if you like.

### 4. " " Manual button

After preheating, press it to start brewing espresso coffee manually, press the button again to stop working during the brewing process. Maximum 60 seconds manual brewing time, machine will stop brewing automatically.

#### **Switch temperature display between Fahrenheit and Celsius:**

Keep press the manual coffee function button for 2 seconds to enter the temperature unit switching mode, and the display flashes. Keep press the manual coffee function button for 2 seconds, the temperature unit can be switched between °F (Fahrenheit) to °C (Celsius). The setting will automatically confirm after 5 seconds without any operation.

# PRODUCT COMPONENTS

## 5. "☕" Steam button

At the standby mode, press this button to preheat for steam function.  
After preheating is completed, the steam button indicator stays on.

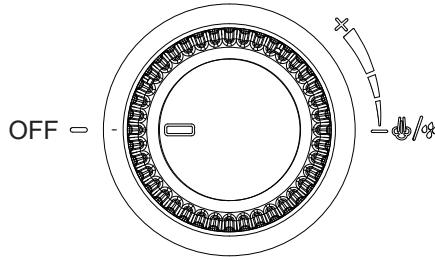

## 6. Steam control knob

The steam control knob is closed when the knob is pointing "OFF -".  
When the machine is in Coffee mode, turn the knob to make hot water.  
When the machine is in Steam mode, turn the knob to make dry steam.



### Note:

Please make sure the steam control knob is at "OFF" position before you turn on the machine. The steam button indicator will flash and display "E-1" if the steam control knob is not at "OFF" position, turn the knob back to "OFF" position and the machine work normally.

# PRODUCT COMPONENTS

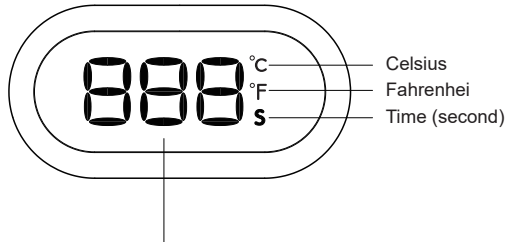

## DISPLAY





Time and temperature digital display

1. "    "

Coffee brewing preheating or steam preheating process.

2. "  " or "  "

After the coffee brewing preheating is completed, the status is displayed in Celsius or Fahrenheit.

3. "  " or "  "

After the steam preheating is completed, the status is displayed in Celsius or Fahrenheit.

4. "  "

Displays the coffee brewing time or making hot water/steam time.

5. "  "

The steam control knob is turned on: When turn on the machine, the steam preheat indicator keeps flashing quickly, which means that the steam control knob is not turned off. Solution: Turn the steam knob to the OFF position.

6. "  "

The machine internal temperature is too high: When switch to coffee brewing mode after making steam immediately, the machine internal temperature is too high to brew coffee. Solution: Wait a moment for the machine internal temperature cool down naturally or turn on the steam control knob to release the hot water to cool down (put a cup under the steam wand).

7. "  "

The temperature sensor is short-circuited or open, the temperature fuse is open, or the connection between the power board and the display board is poor. Solution: Please contact the Customer Service Center.



# HOW TO USE

## BEFORE THE FIRST USE

1. Move the coffee maker from the package, and check the accessories according to the list.
2. Remove the red silicone from the water tank before using the coffee maker.



**Note:**

If don't remove the red silicone cap, the machine will be unable to pump water.

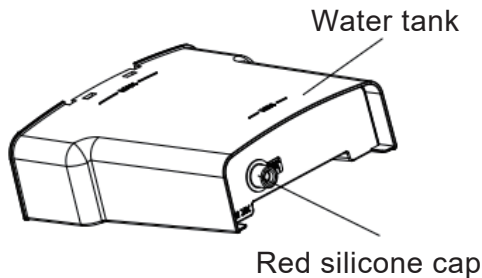

3. Clean all the detachable parts.
4. Pour water into water tank and the water level should not exceed the "MAX" mark, put it back on the machine and close the water tank cover.
5. Plug in and press Power button, all coffee indicators are flashing, the machine starts to preheat. When the indicators stop blinking and keep on, the preheat function is completed, it takes about 1 minutes. Steam indicator is off.
6. After the preheating is completed, put a big cup under the steam wand, turn the Steam control knob counterclockwise to the maximum position, and the electromagnetic pump works until continuous hot water comes out from the steam wand. Keep making hot water for 30~60 seconds, and then turn off the Steam control knob. This process in order to pump water into machine and clean the pipe.
7. Insert the Filter to the Filter holder.

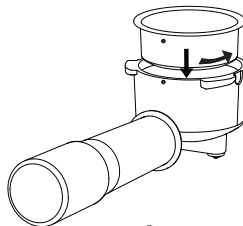

# HOW TO USE

- From position "☺" to position "☹", rotate counterclockwise to install the Filter holder (No coffee powder added) into the machine, place a cup on Drip tray then touch the Double-cup coffee button "☺" to let the hot water out to wash the coffee filter and the cup.

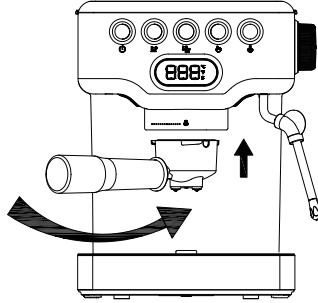

## MAKING THE ESPRESSO

- Open the lid, take out water tank, and fill cold water into water tank NOT exceed the "MAX" line. Set up the water tank vertically and align the buckles to the hole on the back of the machine, press it down and close the lid.

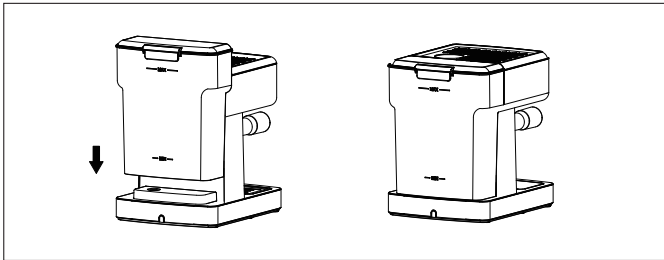

- Plug in and press the Power button "⏻" all coffee indicators will flash, machine starts preheating, preheating will be finished within 1 minute, coffee button indicators will stay on.
- Remove the filter holder, install the filter in filter holder and fill ground coffee into the filter. Evenly press down the ground coffee into the filter with the measure scoop. Please keep the rim of the filter clean after each filling.



**Note:**

If too much coffee powder remains on the edge of the screen, it is easy to cause poor sealing and water leakage.

# HOW TO USE

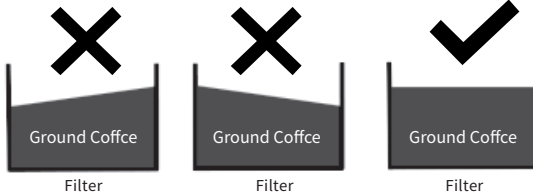
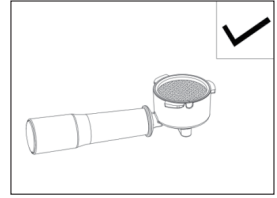
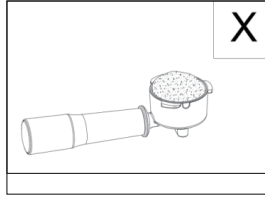
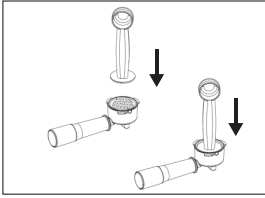

4. Install the filter holder into coffee outlet at "☞" position. Hold the machine by one hand, using another hand to rotate the filter hold to "☛" position.

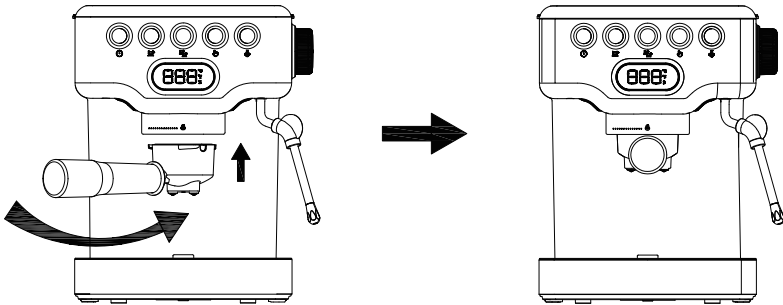

5. Place a cup on the drip tray. After all coffee indicators stop flashing, press the single-cup button "☛" or double-cup coffee button "☞" or manual button "☜", the machine will start brewing.
6. The coffee machine will stop automatically when coffee brewing finished. During coffee brewing, you can press the coffee button again to stop the operation if you like.



## Warning:

Do not leave the coffee machine unattended during the coffee making process, as it sometimes requires manual operation.

# HOW TO USE

7. After the coffee is made, remove the filter holder by rotating it clockwise, clean the coffee grounds in the filter in time, and rinse it with hot water.



## **Warning:**

Do not touch the hot surfaces of the machine with hands to avoid scald, especially brewing outlet, steam nozzle when using machine.

## **FROTHING MILK / MAKING CAPPUCCINO**

To prepare a traditional cappuccino or latte, we recommend:

1. Prepare espresso first with a large enough cup according to "MAKING THE ESPRESSO" part.
2. Using cold (39°F-50°F), fresh whole milk, and pour milk in 1/3 of cup/jug. The density of the frothed milk will depend on the milk fat content. The volume of milk will increase after frothing.
3. Using stainless steel, circular, rounded milk jugs, narrower at the top, with a spout, necessary to make cappuccino decorations.
4. Before starting, it is important to slightly move the Steam Wand outwards in order to insert the jug directly under it and facilitate the movements required to froth the milk correctly.



## **Tips:**

When selecting a cup size, it is recommended that the diameter of the cup be no less than 2.75inch. As the volume of milk will increase after foaming, make sure that the cup has enough height.

5. Press steam button " ☁ ", it starts preheating, the steam indicator is flashing, when machine preheating finished the steam indicator lights on.
6. Put an empty cup under the steam wand, turn the steam control knob counterclockwise to the maximum position, release a little water in the steam wand, and turn the steam control knob clockwise to turn off the steam after the steam comes out.
7. Put the cup/jug with milk under the steam wand, place the steam nozzle just below the surface of the milk. If it is inserted too deep, the milk will not be frothed; if it is not inserted deep enough, big bubbles will be produced and then disappear immediately.

# HOW TO USE

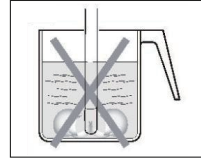
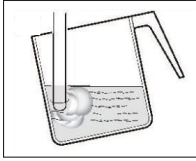

It is important to keep the nozzle not at the center but close to the edge of the jug, with an appropriate angle to produce a stronger vortex.

8. Rotate the steam control knob counterclockwise to let the steam comes out.



**Note:**

The steam pressure increases as the knob is rotated. The entire operation should last no longer than 60 seconds. To froth the milk correctly, the steam nozzle must always be in contact with the milk and not with the froth. Therefore, as the layer of froth increases, the jug must be slightly raised trying to keep the nozzle in contact with the milk, without touching the bottom of the jug.

9. Once the desired frothing has been achieved, the steam nozzle must be pushed deeper to heat the milk well.



**Tips:**

It is advisable to always keep a hand on the rounded part of the jug to feel the temperature increase of the unfrothed milk.

10. Once the desired result has been achieved, close the steam control knob, by rotating it clockwise, to stop dispensing steam and remove the jug.



**Tips:**

To make the froth more compact, it is advisable to lightly tap the jug on a flat surface after frothing.

11. Pour the frothed milk into prepared espresso, now cappuccino is ready.



**Warning:**

The Steam Wand may be very hot during and after use. To avoid scalds, move it only by placing your fingers on the rubber tip fitted on the Steam Wand.

## HOW TO USE

---

12. Place an empty cup under the steam wand. Press steam button " ☽ " to switch off the steam mode, the coffee indicators will be flashing. Turn on the steam control knob and making hot water for 5s in order to clean the inside of steam wand nozzle. Turn off the steam control knob, ready to make the next cup of coffee.



**Note:**

After frothing milk, please clean the milk on the surface of steam wand assembly immediately. This process also can help to cold down the machine internal temperature, let the machine ready for next cup of coffee brewing faster.

### MAKING HOT WATER

1. Put a big cup or container under the steam wand.
2. When all coffee indicators stay on, rotate the steam knob to the maximum position, hot water will be come out from steam wand nozzle immediately. In the process of making hot water, the coffee indicators flash slowly.
3. When the hot water reaches the required amount, turn the steam knob clockwise to the off position, and the hot water stops flowing out.



**Note:**

The hot water function can also be used to quickly cool down the coffee machine.



**Warning:**

When the machine is working, be careful of the hot parts of the machine. Especially the coffee outlet, filter holder, steam wand and nozzle. When operating, please do not put your hands on the above parts for any reason

# CLEANING AND MAINTENANCE

---

Regular cleaning and maintenance keep the machine in working condition and ensure perfect coffee flavor, a constant coffee flow, and excellent milk froth for a long period of time.

Disconnect the appliance from the mains and let it cool down before cleaning it with damp cloth.

Clean all the attachments in the water and dry thoroughly.



**Warning:** Do not use abrasive sponges and alcohol or solvents.  
Do not immerse the machine into water.

## CLEANING THE FILTER HOLDER AND THE FILTER

The filters should be kept clean to guarantee perfect results.

1. Remove the filter from the filter holder and wash it with warm water.
2. If you notice a malfunction when brewing coffee, immerse the filter in boiling water for 10 minutes and then rinse with running water.



**Warning:** To avoid scalds, the filter must only be replaced when the filter holder has cooled down completely.

## CLEANING THE STEAM WAND

After each milk frothing:

1. Clean the Steam wand with a damp cloth. To clean it more thoroughly, you can unscrew the nozzle and wash it with running water.
2. Open the steam knob, allowing the steam to escape for one or two seconds to clear the nozzle hole.
3. Clean the nozzle with wet sponge.

## CLEANING THE GRID AND DRIP TRAY

Remove the drip tray and the grid and wash them with water. Do not use abrasive cleaning tools.

# CLEANING AND MAINTENANCE

---

## CLEANING THE WATER TANK

Remove the Water tank and wash it with fresh water.



**Warning:**

To avoid scalds, the tank should be cleaned only when the machine is turned off. The drain hose may reach high temperatures during operation.

## CLEANING THE BREW UNIT

Regularly remove any residual coffee grounds from the Brew unit using a brush and wash with hot water following the steps below.

1. Do not insert the Filter holder.
2. Place an empty cup under the Brew unit.
3. Press the coffee button and fill the cup with water.
4. Wait the machine stop automatically, or press the coffee button again to stop.
5. After the machine cool down, get rid of coffee residue inside the brew unit with the damp cloth.



# TROUBLESHOOTING

PROBLEM	CAUSE	SOLUTION
No water comes out	Water tank is empty	Fill in water and turn on the steam control knob until hot water comes out continuously from the steam wand.
	The input voltage or frequency is inconsistent with nameplate	Make sure the voltage and frequency is consistent with the rating label.
	Machine malfunctions	Please contact with the Customer Service Center.
No steam is generated	Steam nozzle clogged	Clean steam nozzle.
	Water tank is empty	Fill in water and turn on the steam control knob until hot water comes out continuously from the steam wand. Now you can start to steam.
	Machine malfunctions	Please contact with the Customer Service Center.
Coffee runs out around the edge of the filter holder	Too much powder in the filter	Turn off the machine and wait for it cool down, clean the filter then pour appropriate coffee powder.
	There is powder in the seal ring under group head	
	Implementation of the above operation problems still exist	Please contact with the Customer Service Center.
Coffee comes out too slow or no coffee comes out	Coffee powder is too fine, and Clogged filter	With thicker coffee powder.
	Filter holes are blocked	Brush / clean the filter.
	Water tank is not inserted	Insert the water tank in place.
Water leakage on the bottom of machine	Drip tray is filled up	Please clean the drip tray.
Machine is not working	Machine malfunctions	Please contact with the Customer Service Center.
	The power cord is not plugged well	Plug the power cord into a wall outlet correctly.
	NTC is short circuit	
	Machine malfunctions	Plug the power cord into a wall outlet correctly.

# TROUBLESHOOTING

---

<b>PROBLEM</b>	<b>CAUSE</b>	<b>SOLUTION</b>
The steam cannot froth	Steam indicator doesn't light on	Wait steam indicator lights on.
	The container is too big or the shape is not fit	Use high and narrow cup or garland cup.
	Used skimmed milk	Use whole milk.

\*If you were not able to solve the problem, contact customer support in your country.

# LIMITED WARRANTY

---

## LIMITED WARRANTY

Geek Technology Ltd. warrants to the original consumer or purchaser this Geek Chef Espresso Coffee Maker is free from defects in material or workmanship for a period of One (1) year from the date of purchase. If any such defect is discovered within the warranty period, Geek Technology Ltd. at its discretion, will repair or replace the Product at no cost. This limited warranty is good only to the original purchaser of the product and effective only when used in United States.

For warranty or repair service: Call 1-844-801-8880 and choose the appropriate prompt, or email [info@geektechnology.com](mailto:info@geektechnology.com). Please have your Product's model number, date code (on rating label), your name, address, city, state, zip code and phone number ready.

NO OTHER WARRANTY IS APPLICABLE TO THIS PRODUCT. THIS WARRANTY IS IN LIEU OF ANY OTHER WARRANTY, EXPRESS OR IMPLIED. INCLUDING WITHOUT LIMITATION, ANY WARRANTY OF MERCHANTABILITY OR FITNESS FOR A PARTICULAR PURPOSE. TO THE EXTENT ANY IMPLIED WARRANTY IS REQUIRED BY LAW. IT IS LIMITED IN DURATION TO THE EXPRESS WARRANTY PERIOD ABOVE. NEITHER THE MANUFACTURER NOR ITS U.S. DISTRIBUTOR SHALL BE LIABLE FOR ANY INCIDENTAL, CONSEQUENTIAL, INDIRECT, SPECIAL, OR PUNITIVE DAMAGES OF ANY NATURE. INCLUDING WITHOUT LIMITATION. LOST REVENUES OR PROFITS, OR ANY OTHER DAMAGE WHETHER BASED IN CONTRACT, TORT, OR OTHERWISE, SOME STATES AND/OR TERRITORIES DO NOT ALLOW THE EXCLUSION OR LIMITATION OF INCIDENTAL OR CONSEQUENTIAL DAMAGES OR LIMITATIONS ON HOW LONG AN IMPLIED WARRANTY LASTS. SO THE ABOVE EXCLUSION OR LIMITATION MAY NOT APPLY TO YOU. THIS WARRANTY GIVES YOU, THE ORIGINAL PURCHASER, SPECIFIC LEGAL RIGHTS AND YOU MAY ALSO HAVE OTHER RIGHTS THAT VARY FROM STATE TO STATE OR TERRITORY TO TERRITORY.

## THIS LIMITED WARRANTY DOES NOT APPLY TO :

1. Failure of product to perform during power failures and interruptions or inadequate electrical service.
2. Damage caused by transportation or handling.
3. Damage caused to the product by accident, vermin, lightning, winds, fire, floods, or acts of God.
4. Damage resulting from accident, alteration, misuse, abuse, or improper installation, repair, or maintenance. Improper use includes using an external device that alters or converts the voltage or frequency of electricity.
5. Any unauthorized product modification, repair by unauthorized repair center, or use of non-approved replacement parts.
6. Abnormal cleaning and maintenance as described in the user's manual.
7. Use of accessories or components that are not compatible with this product.



Geek Technology Ltd.  
1275 Bloomfield Ave  
Fairfield, NJ 07004  
Toll Free 1-844-801-8880

Version: --2021.5.0