

ASSEMBLY INSTRUCTIONS

36 INCH BATH VANITY-CABINET

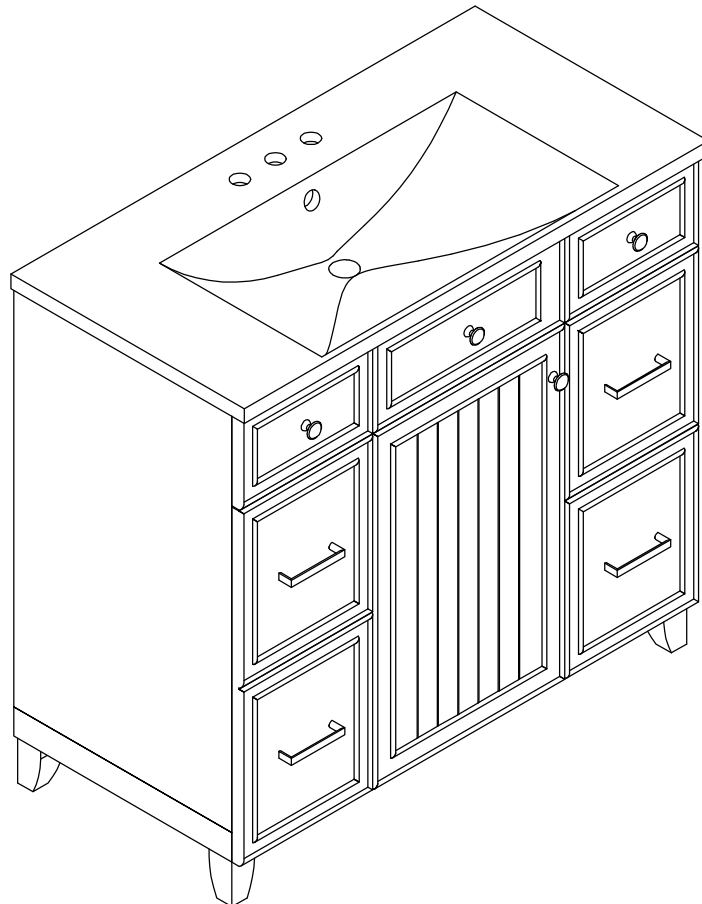

Thank you for purchasing this quality product. Be sure to check all packing material carefully for small parts which may have come loose inside the carton during shipment. Separate, identify and count all parts and hardware. Compare with the parts list to be sure all parts are present.
"DO NOT TIGHTEN SCREWS UNTIL COMPLETELY ASSEMBLED"

*** Use of power tool to assemble this product will invalidate any claim and damage this product making unsafe !!!**
*** Please assemble on a clean soft surface to avoid damage.**

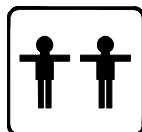

Tools Required

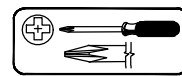

(Not included)

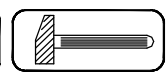

(Not included)

IMPORTANT:

PLEASE READ INSTRUCTION BEFORE STARTING THE ASSEMBLY

Detail View - CABINET

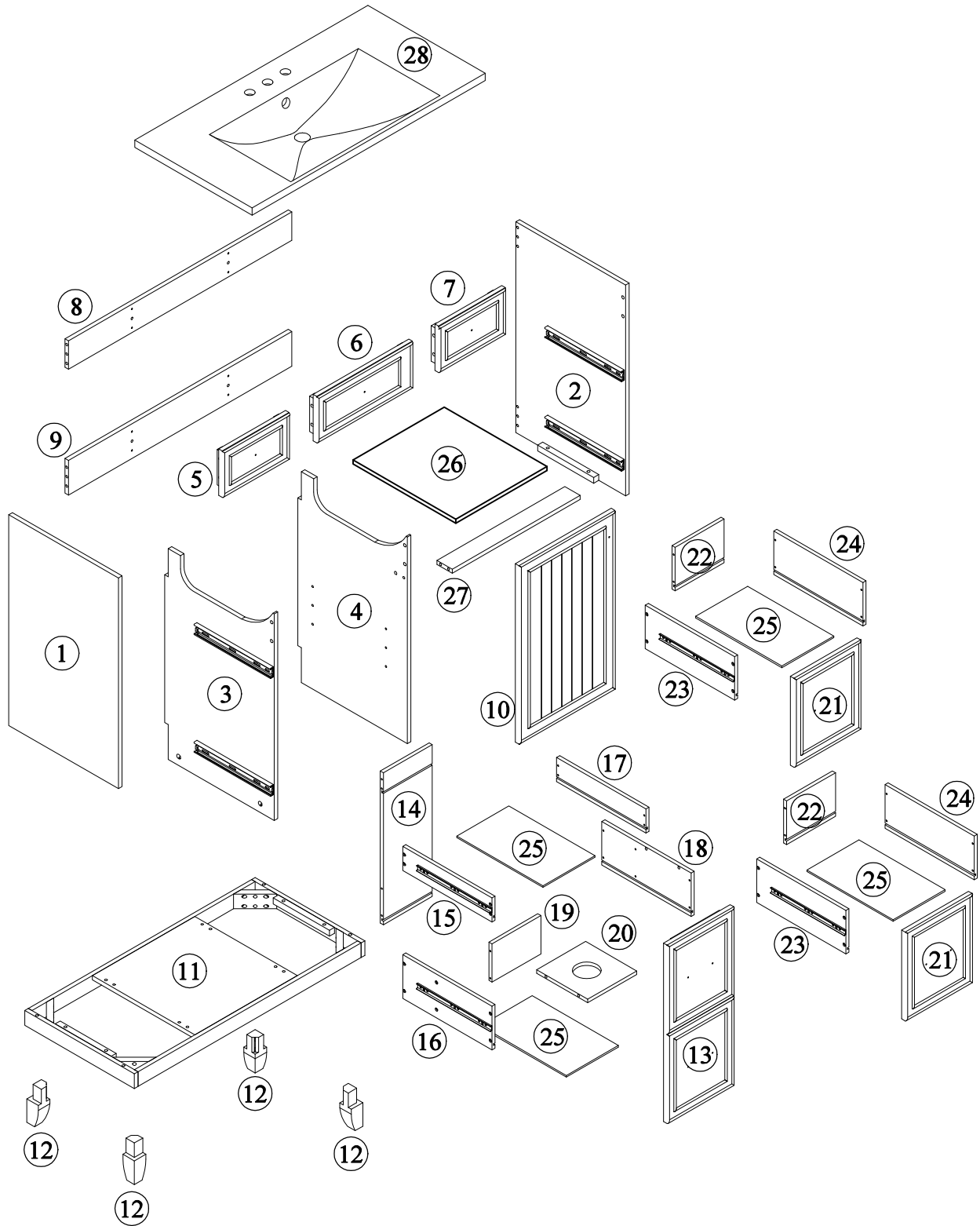



Identifying the Hardware-Identify the hardware using the illustrations below.

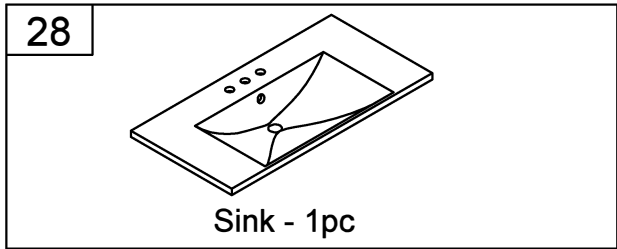





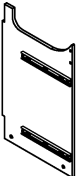
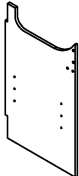
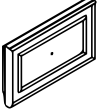
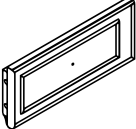
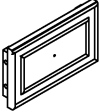
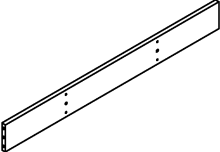
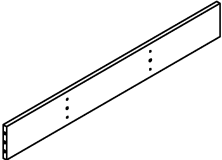
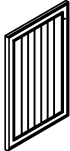

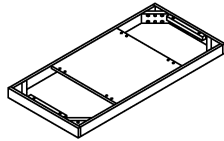

Part List - SV000003AAW

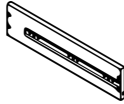
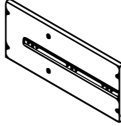

Part List - WF297189

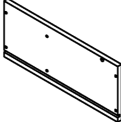
1		2	
Side Panel (L) - 1pc		Side Panel (R) - 1pc	
3		4	
Mid Fixed Panel (L) - 1pc		Mid Fixed Panel (R) - 1pc	
5		6	
Front Panel (L) - 1pc		Front Panel Mid - 1pc	
7		8	
Front Panel (R) - 1pc		Back Panel Top - 1pc	
9		10	
Back Panel Bottom - 1pc		Door - 1pc	

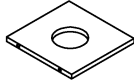
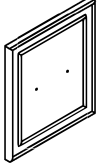

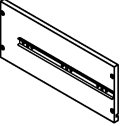
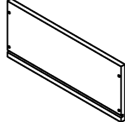



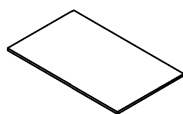
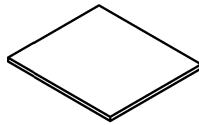
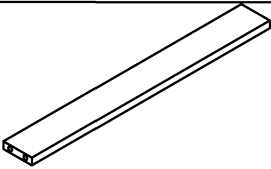



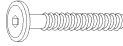

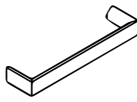
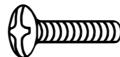

Part List - SV000003AAW

<p>11</p>  <p>Frame Bottom - 1pc</p>	<p>12</p>  <p>Foot - 4pcs</p>
<p>13</p>  <p>Drawer Front (L) - 1pc</p>	<p>14</p>  <p>Drawer Back (L) - 1pc</p>
<p>15</p>  <p>Drawer Side Top(L-L) - 1pc</p>	<p>16</p>  <p>Drawer Side Bottom(L-L) - 1pc</p>
<p>17</p>  <p>Drawer Side Top(L-R) - 1pc</p>	<p>18</p>  <p>Drawer Side Bottom(L-R) - 1pc</p>
<p>19</p>  <p>Drawer Mid - 1pc</p>	<p>20</p>  <p>Drawer Mid Top - 1pc</p>
<p>21</p>  <p>Drawer Front (R) - 2pcs</p>	<p>22</p>  <p>Drawer Back (R) - 2pcs</p>
<p>23</p>  <p>Drawer Side (R-L) - 2pcs</p>	<p>24</p>  <p>Drawer Side (R-R) - 2pcs</p>

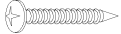
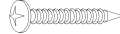
Part List - SV000003AAW

<p>25</p>  <p>Drawer Bottom - 4pcs</p>	<p>26</p>  <p>Adjustable Shelf - 1pc</p>
<p>27</p>  <p>Mid Bar - 1pc</p>	

Hardware List - SV000003AAW

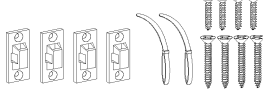
<p>A</p>  <p>ø13x1/4"x28mm</p> <p>Hex-Head bolts(8pcs)</p>	<p>B</p>  <p>ø13x1/4"x38mm</p> <p>Hex-Head bolts(8pcs)</p>	<p>C</p>  <p>ø13x1/4"x50mm</p> <p>Hex-Head bolts(4pcs)</p>
<p>D</p>  <p>ø1/4"x16x1mm</p> <p>Washer(20pcs)</p>	<p>E</p> <p>ø6x35mm</p> <p>Three in one bolts(14pcs)</p>	<p>F</p>  <p>ø14.5x12mm</p> <p>Three in one lock(14pcs)</p>
<p>G</p>  <p>Handle(4pcs)</p>	<p>H</p>  <p>Handle (4pcs)</p>	<p>I</p>  <p>ø5/32"x19mm</p> <p>Handle screw(6pcs)</p>
<p>J</p>  <p>ø5/32"x32mm</p> <p>Handle screw(6pcs)</p>	<p>K</p>  <p>ø8xø4x32mm</p> <p>Round head screw(36pcs)</p>	<p>L</p>  <p>ø8xø4x25mm</p> <p>Round head screw(8pcs)</p>
<p>M</p>  <p>Damping hinge (2pcs)</p>	<p>N</p>  <p>ø7xø3.5x15mm</p> <p>Flat head screw(12pcs)</p>	<p>R</p>  <p>Laminate pad(4pcs)</p>
<p>S</p>  <p>ø8x30mm</p> <p>Wood dowel(22pcs)</p>	<p>T</p>  <p>ø6x30mm</p> <p>Wood dowel(4pcs)</p>	<p>U</p>  <p>4mm</p> <p>Allen key(1pc)</p>
<p>V</p>  <p>Anti fall hardware(1set)</p>		

STEP: 1

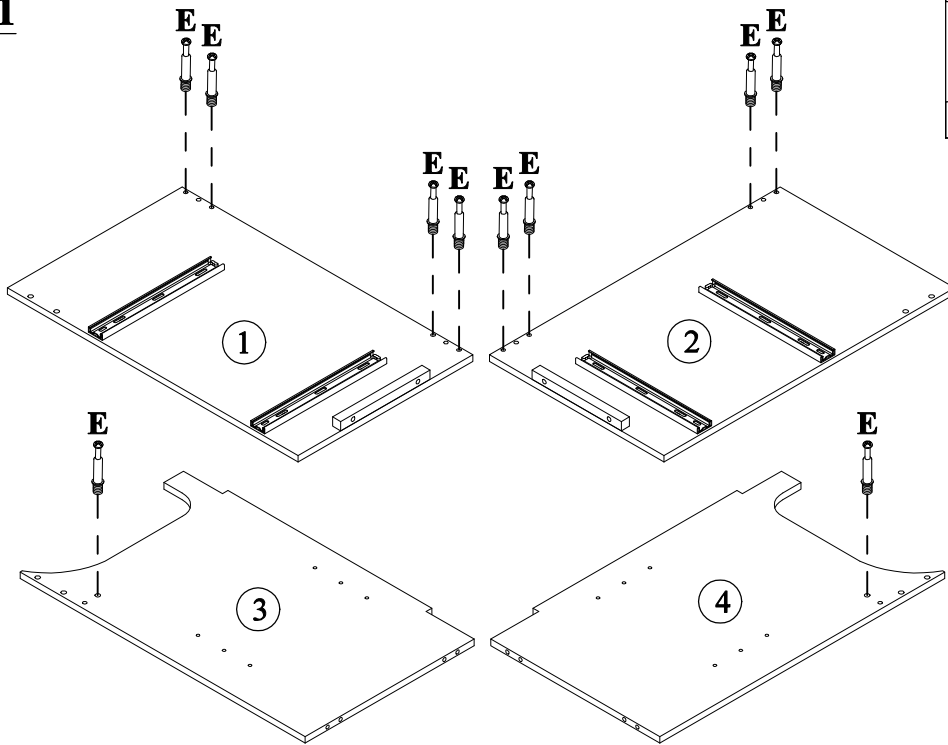

E

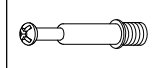

10PCS

Do Not Over Tighten

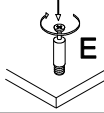

STEP: 2

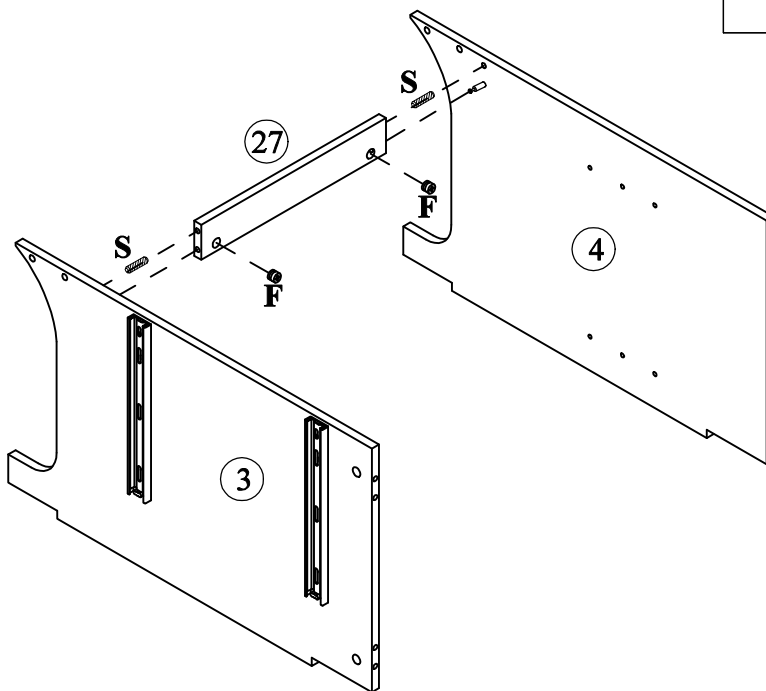

F



2PCS

S

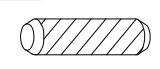

2PCS

STEP: 3

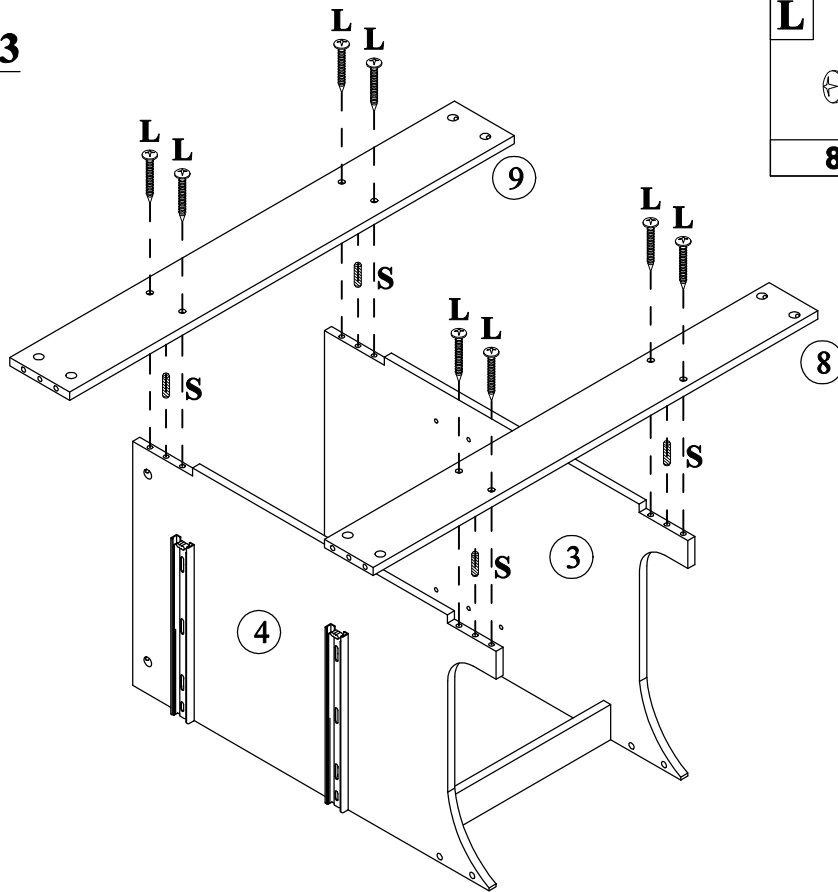

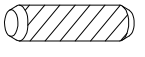

L	S
	
8PCS	4PCS

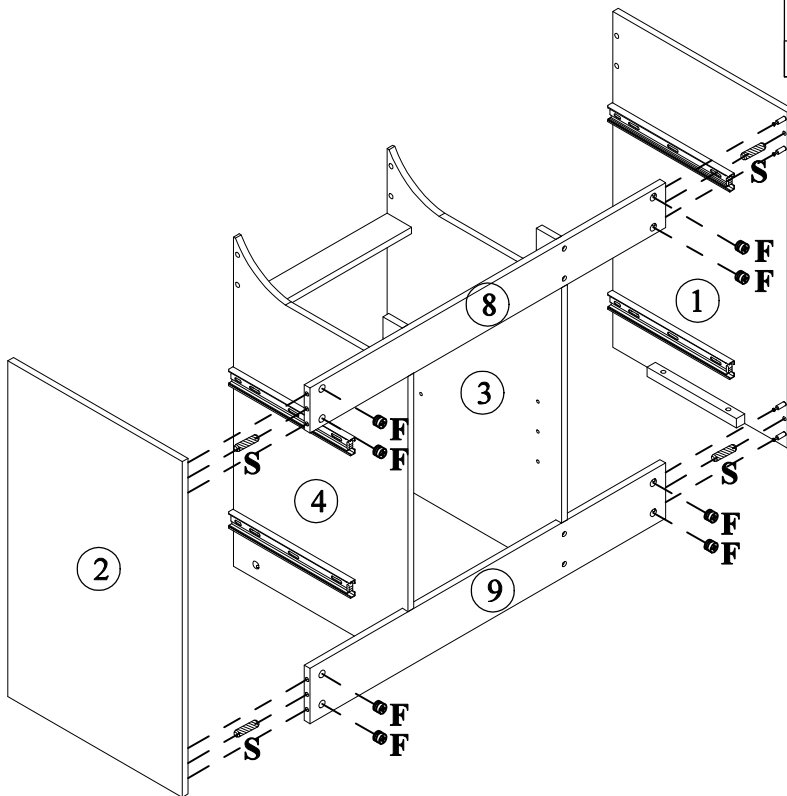
STEP: 4

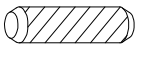

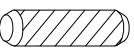

F	S
	
8PCS	4PCS

STEP: 5

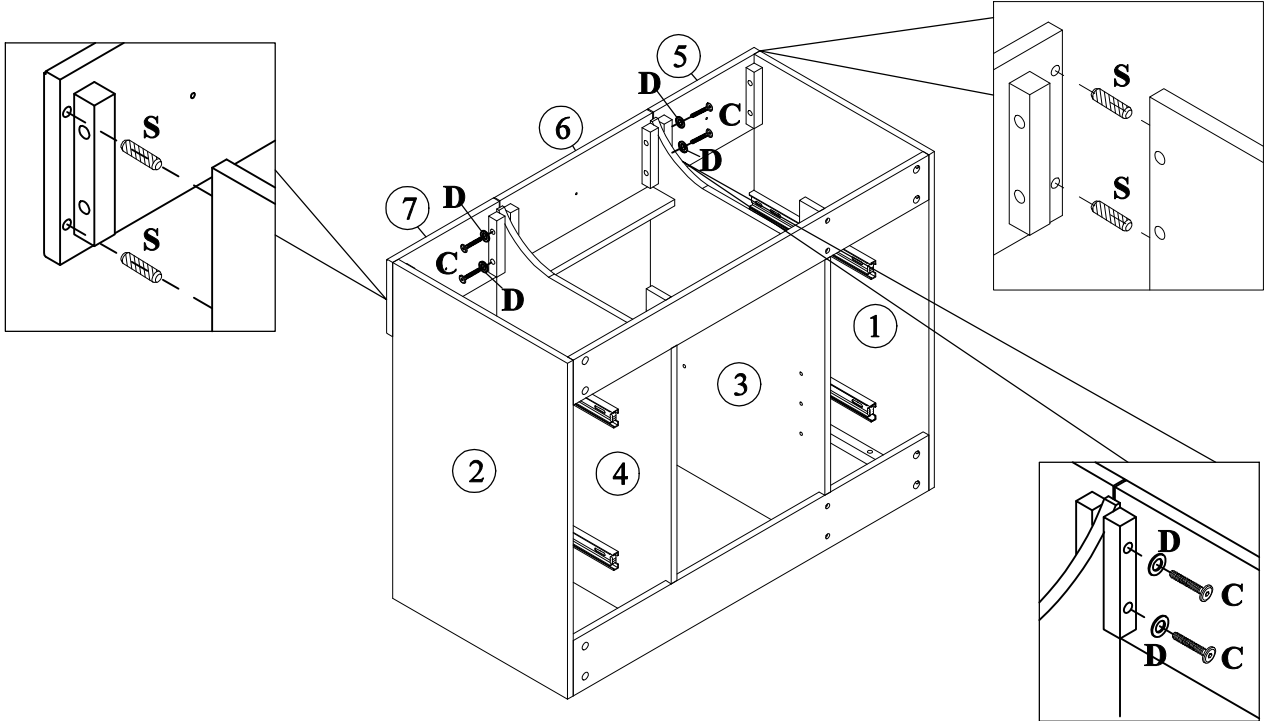
C 	D 	S 
4PCS	4PCS	4PCS



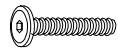

STEP: 6

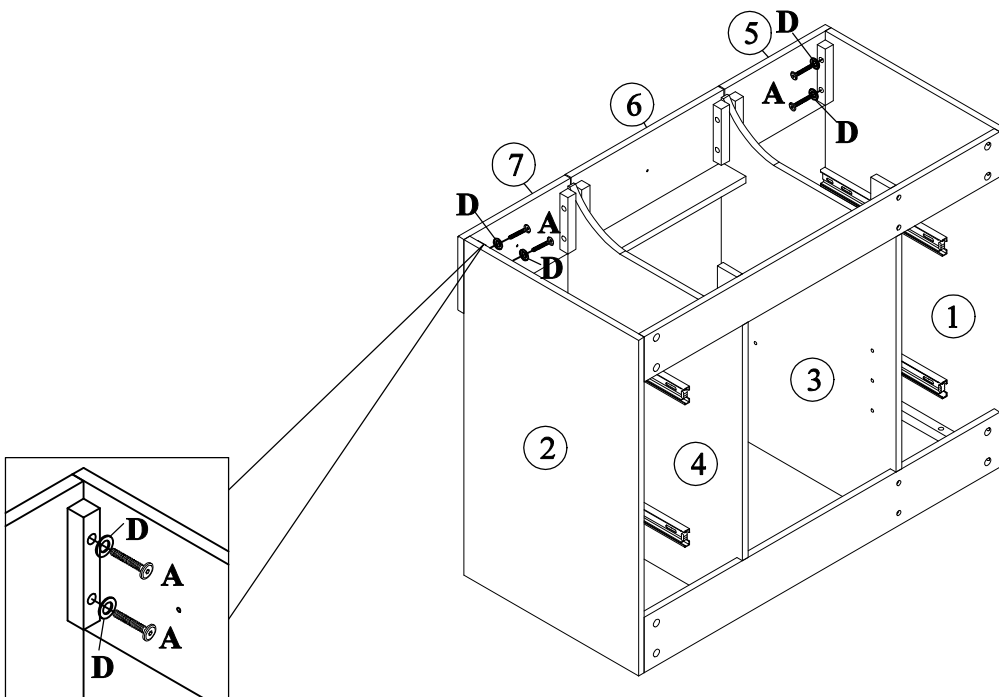
A 	D 
4PCS	4PCS



STEP: 7

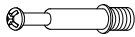

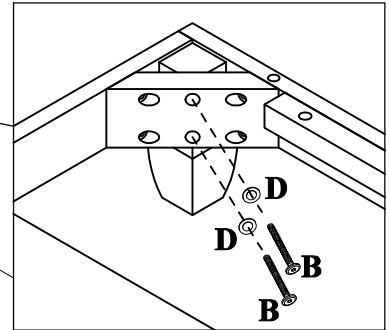
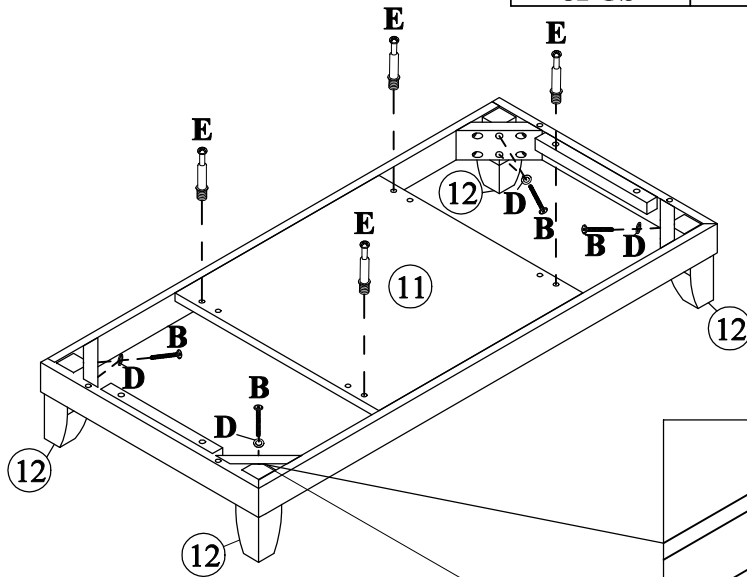
B	D	E
		
8PCS	8PCS	4PCS

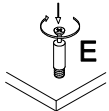

Do Not Over Tighten



STEP: 8

F	S
	
4PCS	8PCS

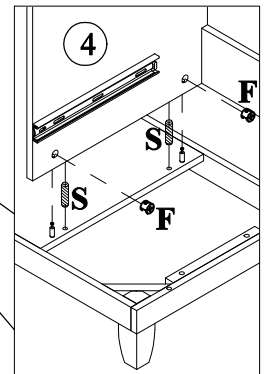
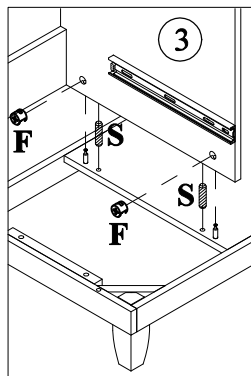
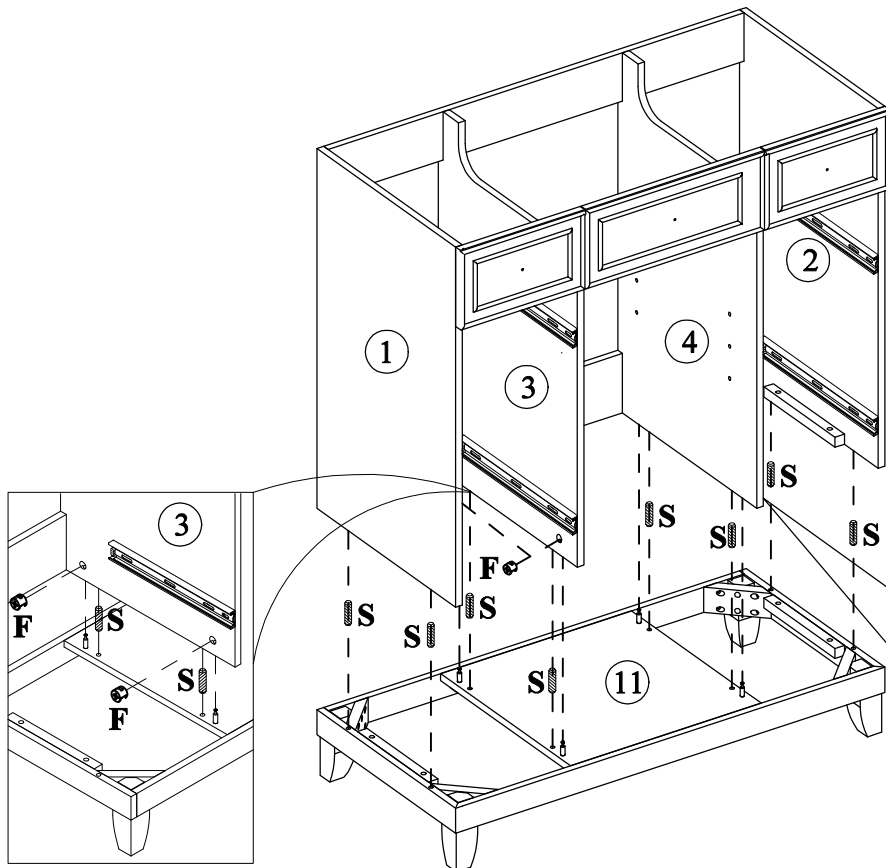

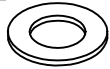

STEP: 9

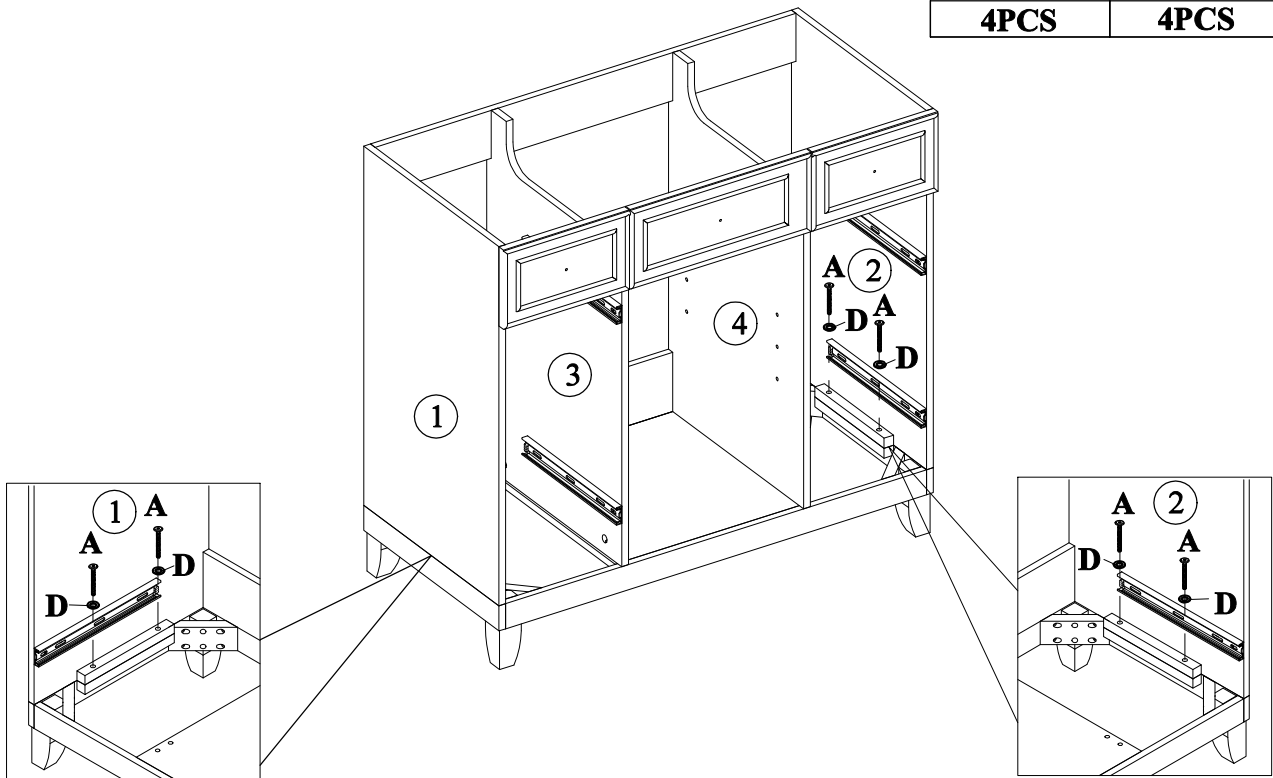
A	D
	
4PCS	4PCS



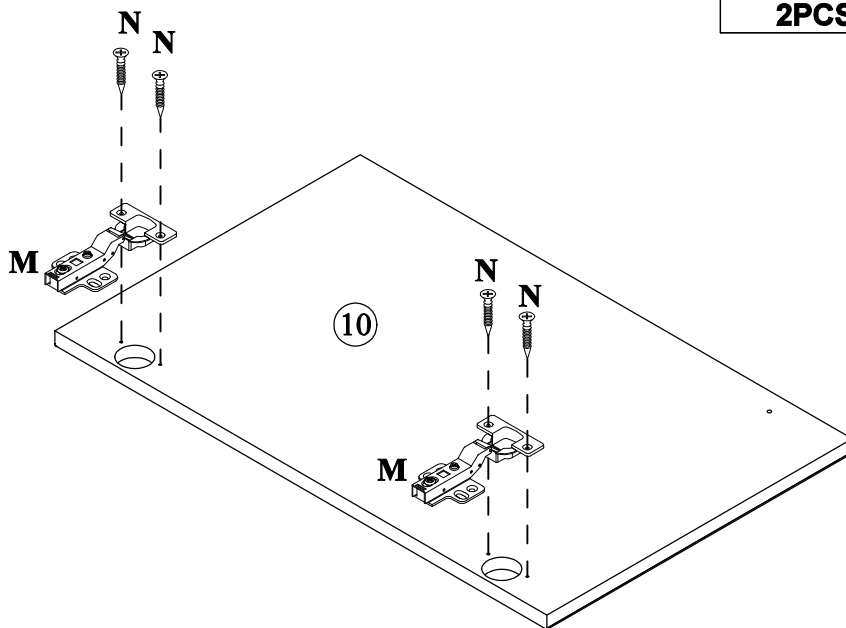

STEP: 10

M	N
	
2PCS	4PCS

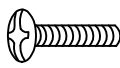

STEP: 11

G	I	N
		
4PCS	4PCS	8PCS

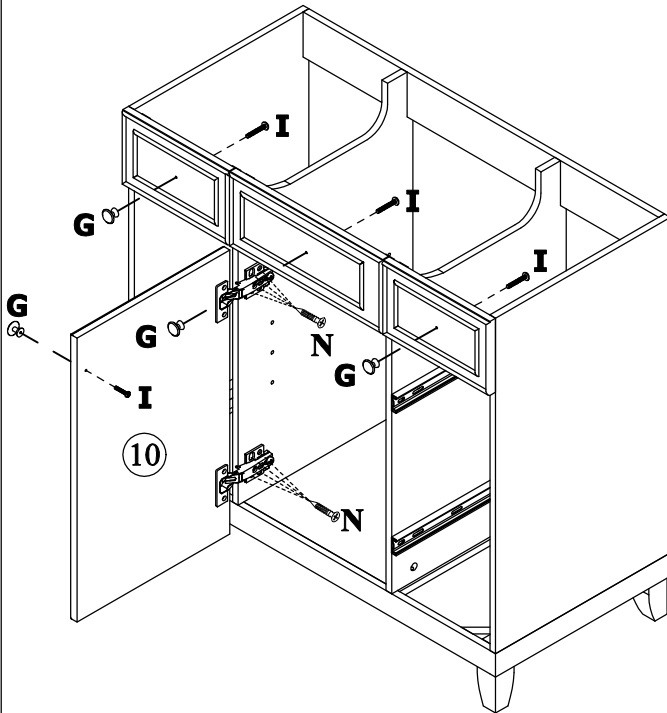

Use the screws to adjust up or down

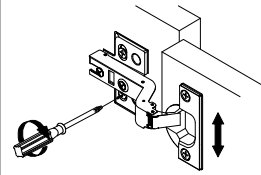

Use the screws to permanent

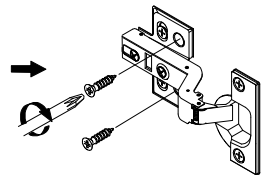

Use the screws to adjust left or right

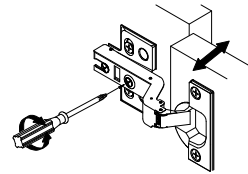

Use the screws to adjust in or out

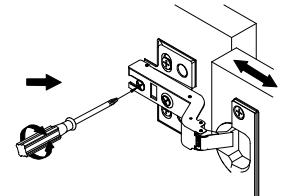

STEP: 12

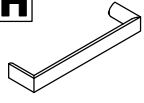
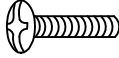
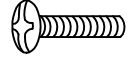
H	I	J
		
2PCS	2PCS	2PCS

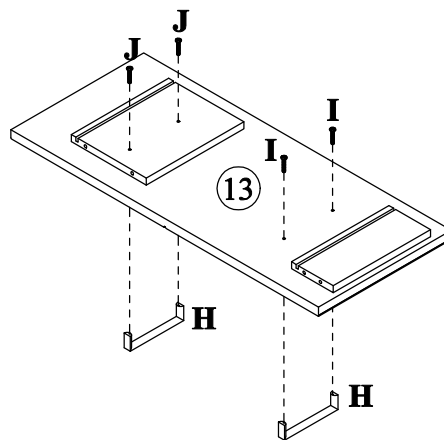

STEP: 13

K



8PCS

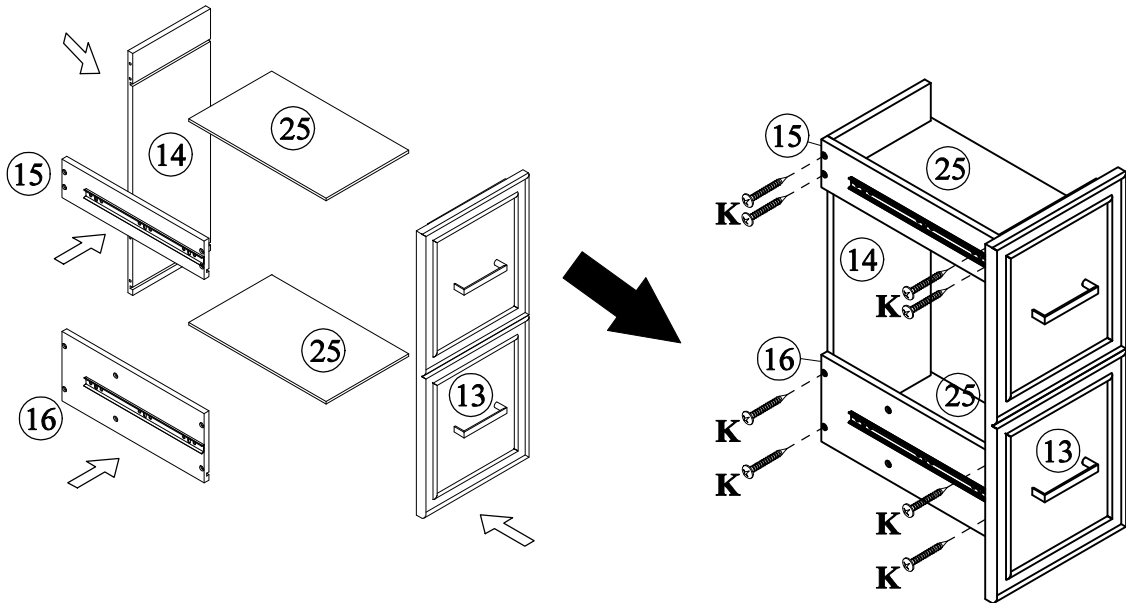

STEP: 14

K



2PCS

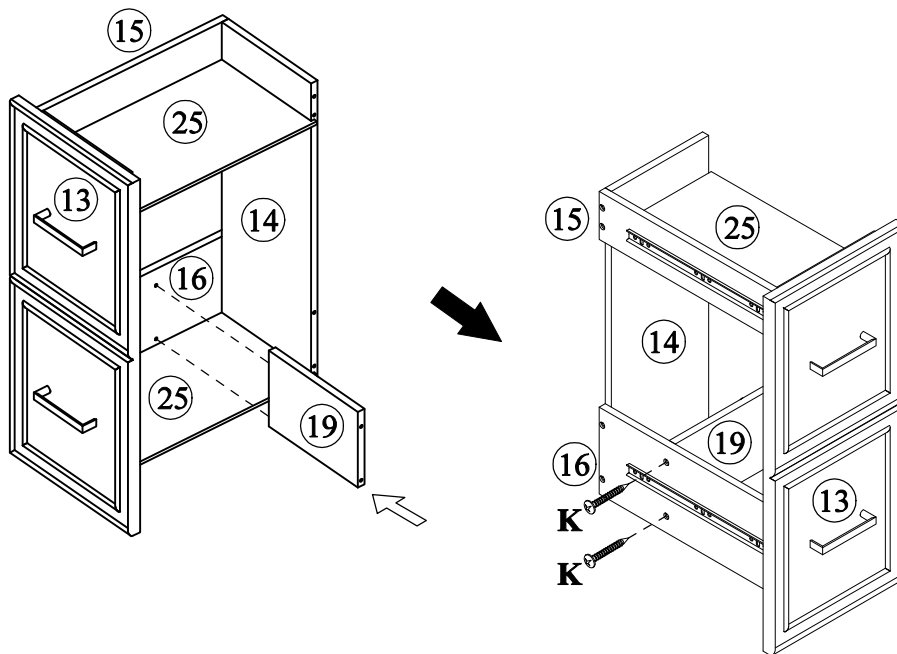

STEP: 15

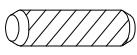
K	T
	
10PCS	4PCS

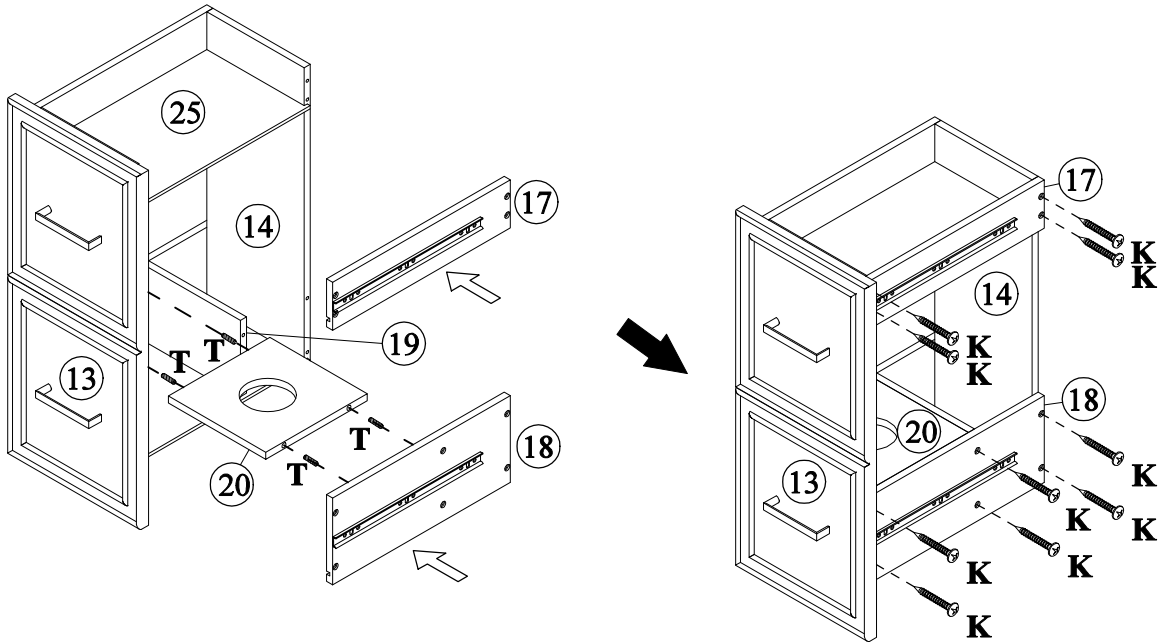

STEP: 16

K

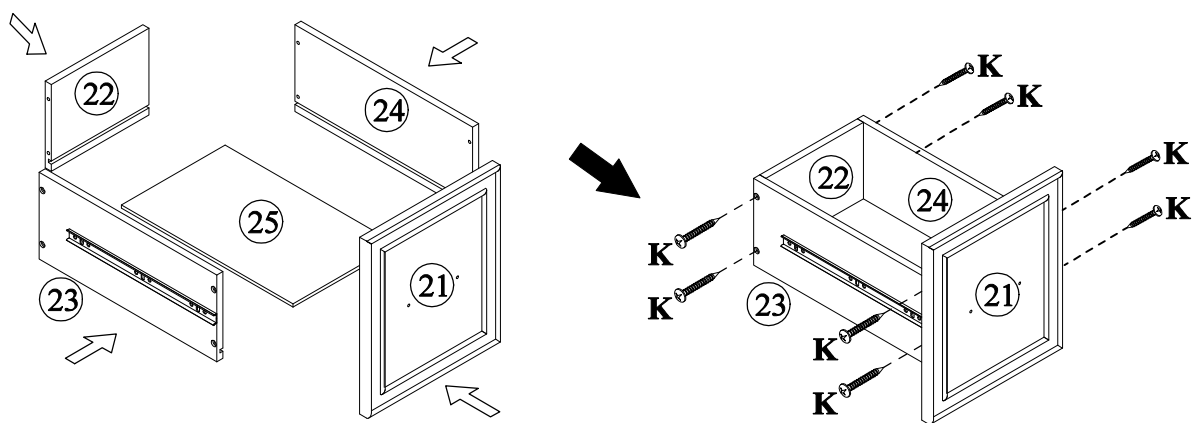
16PCS

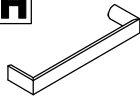
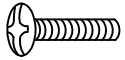

X2

STEP: 17

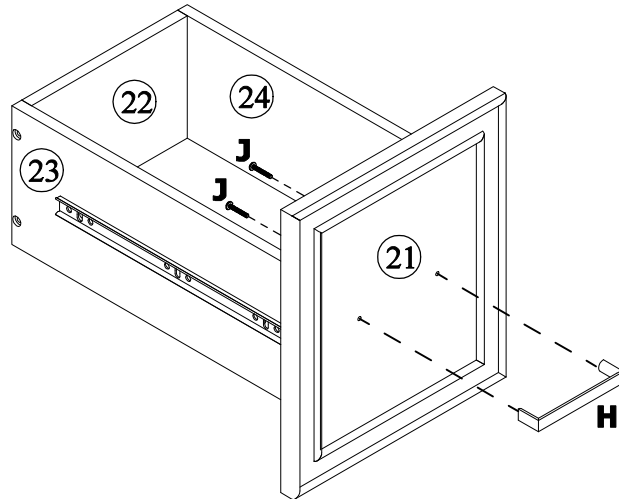
H 	J 
2PCS	4PCS



X2

STEP: 18

R 
4PCS

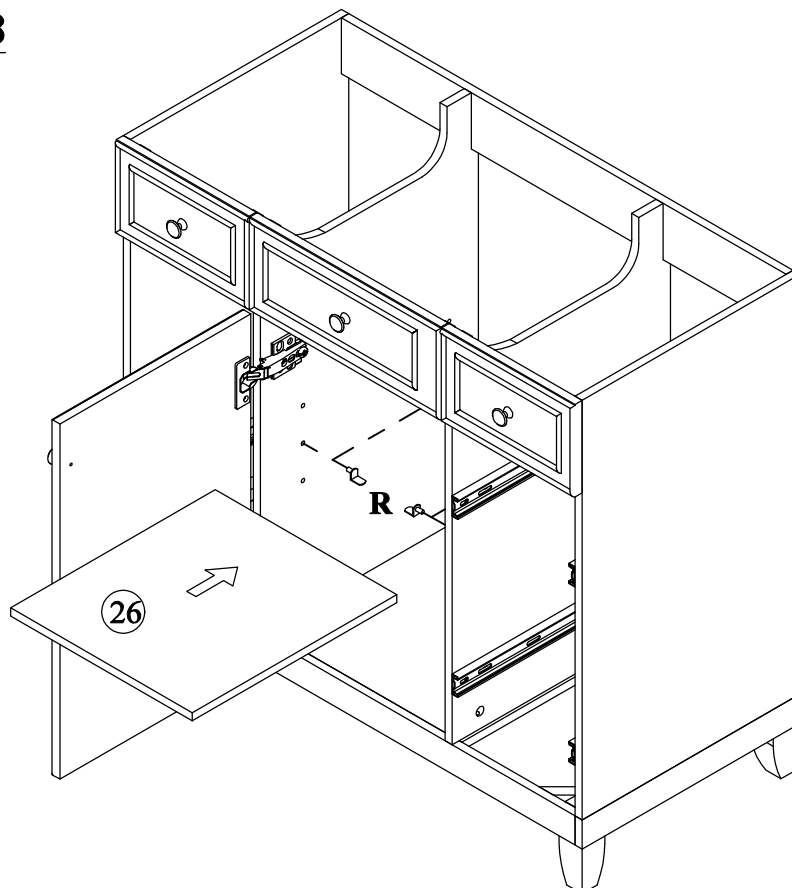

STEP: 19

The structure of the cabinet is quite stable, if you are not sure, you can use anti-falling hardware

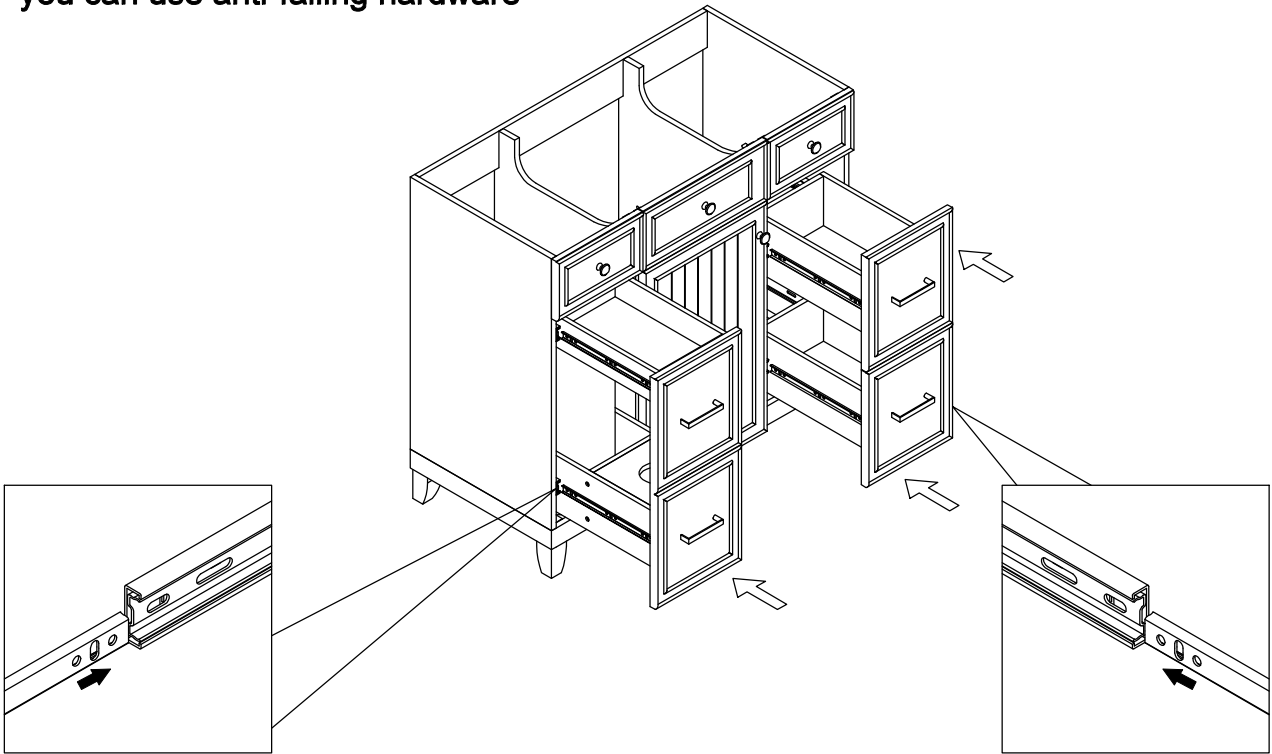

STEP: 20

Install the sink on the cabinet with glue.
Let stand for 24 hours

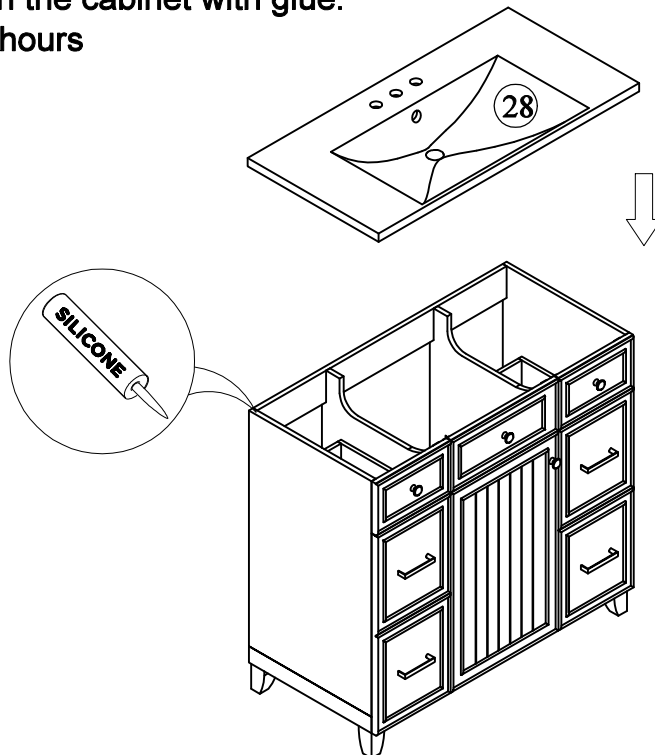

STEP: 21

