















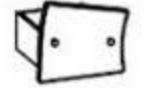
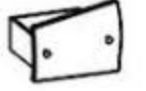





1	Main Cabinet		560*350*1370MM	1
2	Left Arm		376*191*20MM	1
3	Right Arm		335*198*20MM	1
4	Tray		295*20MM	1
5	1st Drawer Installed		344*245*312MM	1
6	2nd Drawer Installed		350*386*312MM	1
7	3rd Drawer Installed		356*304*312MM	1
8	4th Drawer Installed		365*274*312MM	1
9	5th Drawer Installed		481*274*312MM	1
10	Left Leg		325*178*135MM	1
11	Right Leg		325*227*120MM	1

A	Arm Fixing Screws		M6*25MM	4
B	Tray Fixing Screws		M6*55MM	1
C	Tray Fixing Screws		M6*35MM	6
D	Spring Washer		M6	10
E	Flat Washer		M6*16MM	10
F	Allen wrench		M4*60MM	1
G	Wooden Dowel Pins		∅8*30MM	3
H	Wall Anchors			1
I	Furniture Levelers		M6*19MM	2
J	Pull Handle		22*∅19MM	10
K	Handle Fixing Screws		M4*19MM	10

Step 1

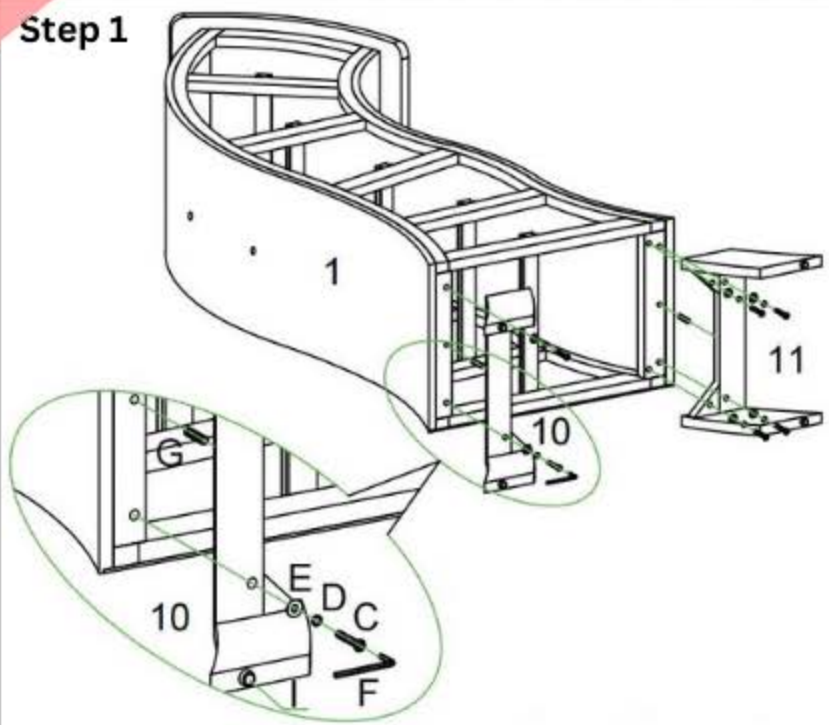

Step 2

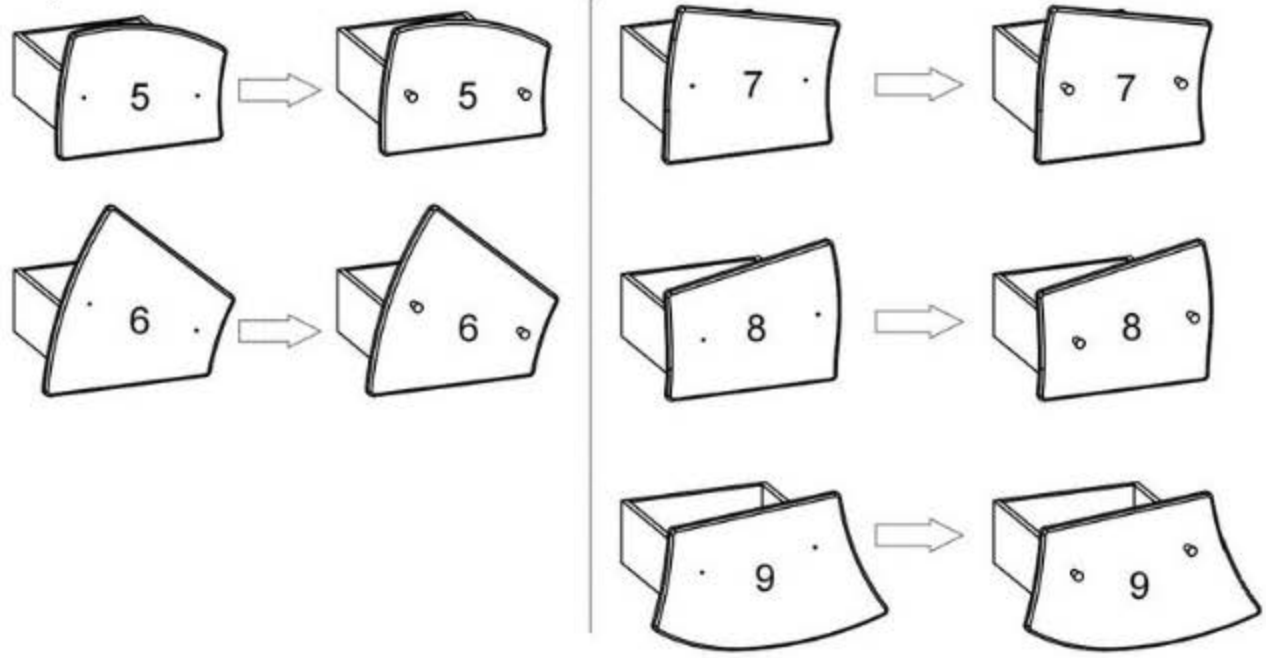

Step 3

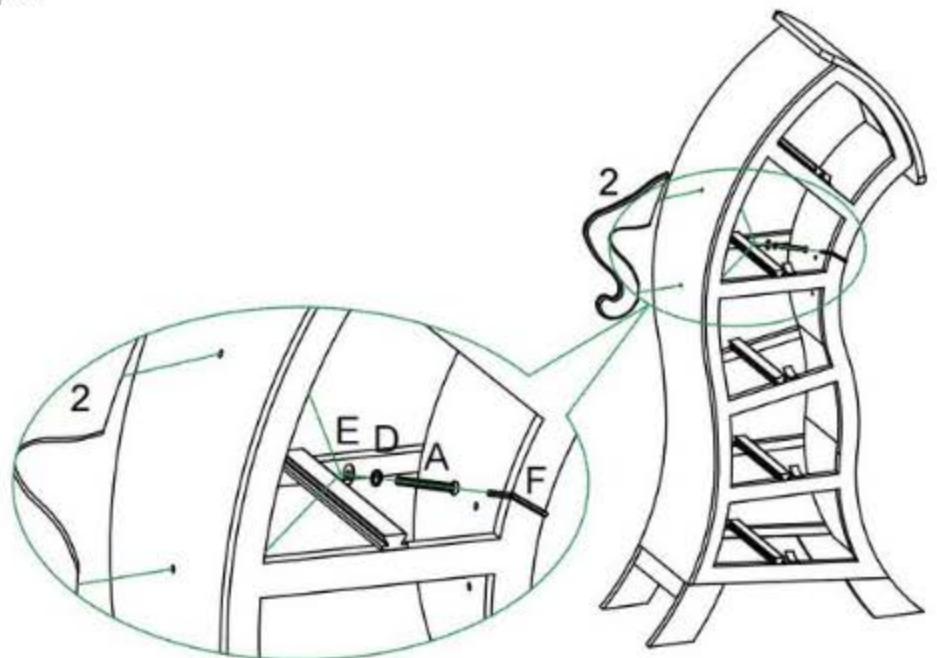

Step 4

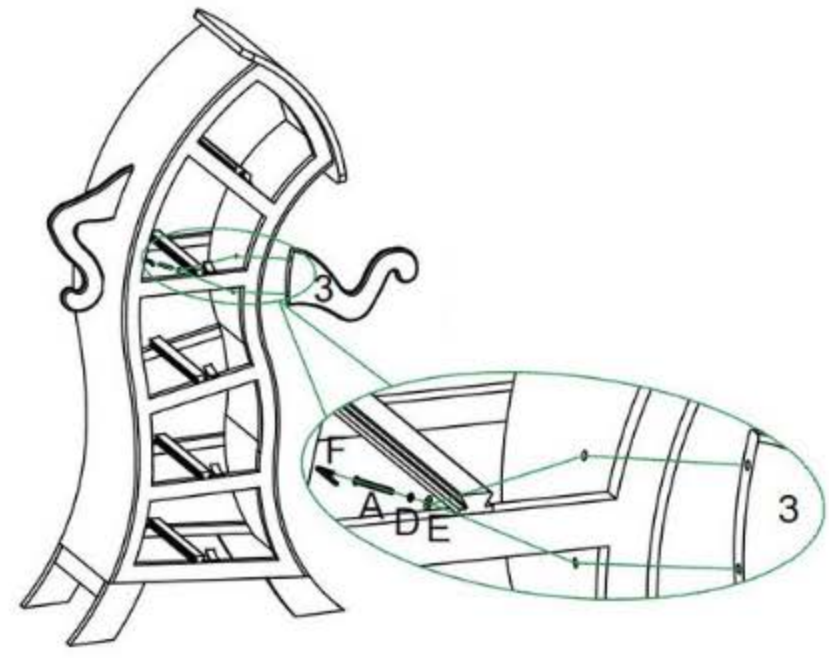

Step 5

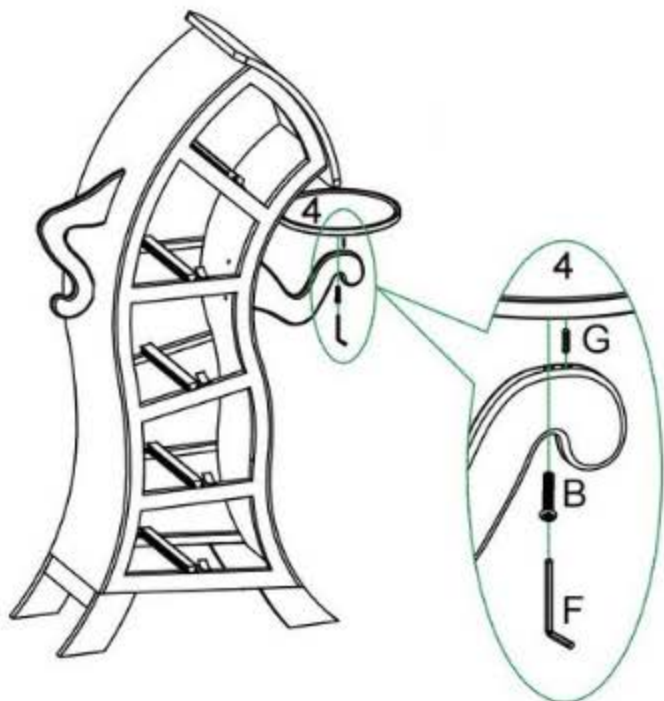

Step 6

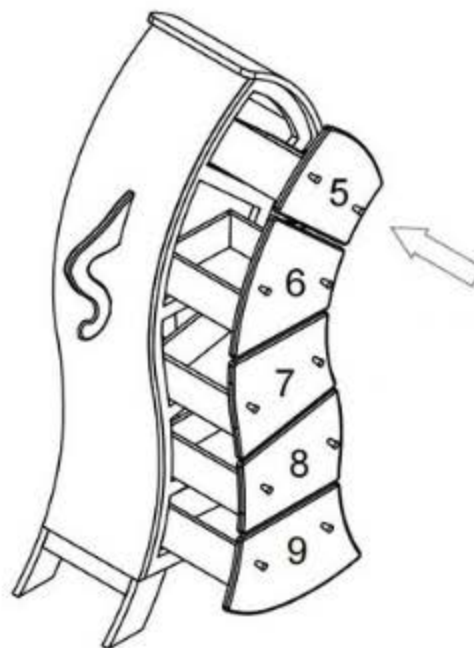

Step 7

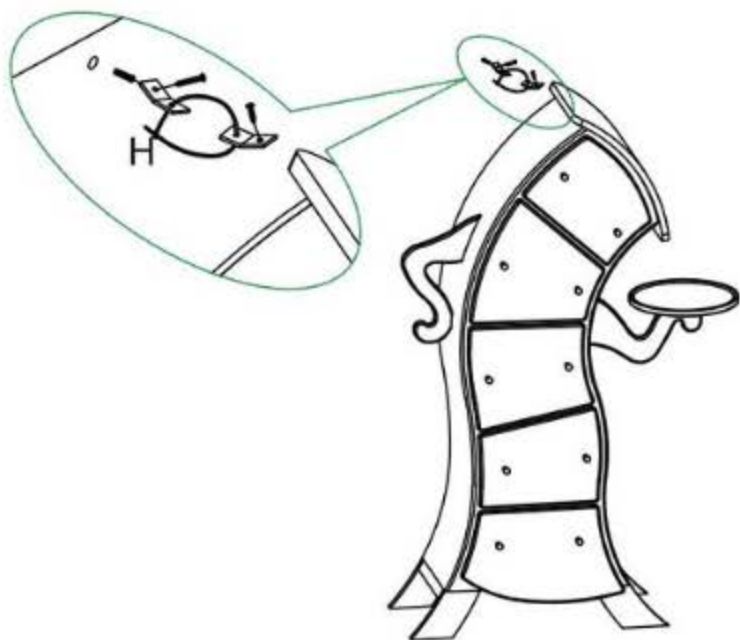

Step 8

