

# Slide & Swing Playset

## USER MANUAL

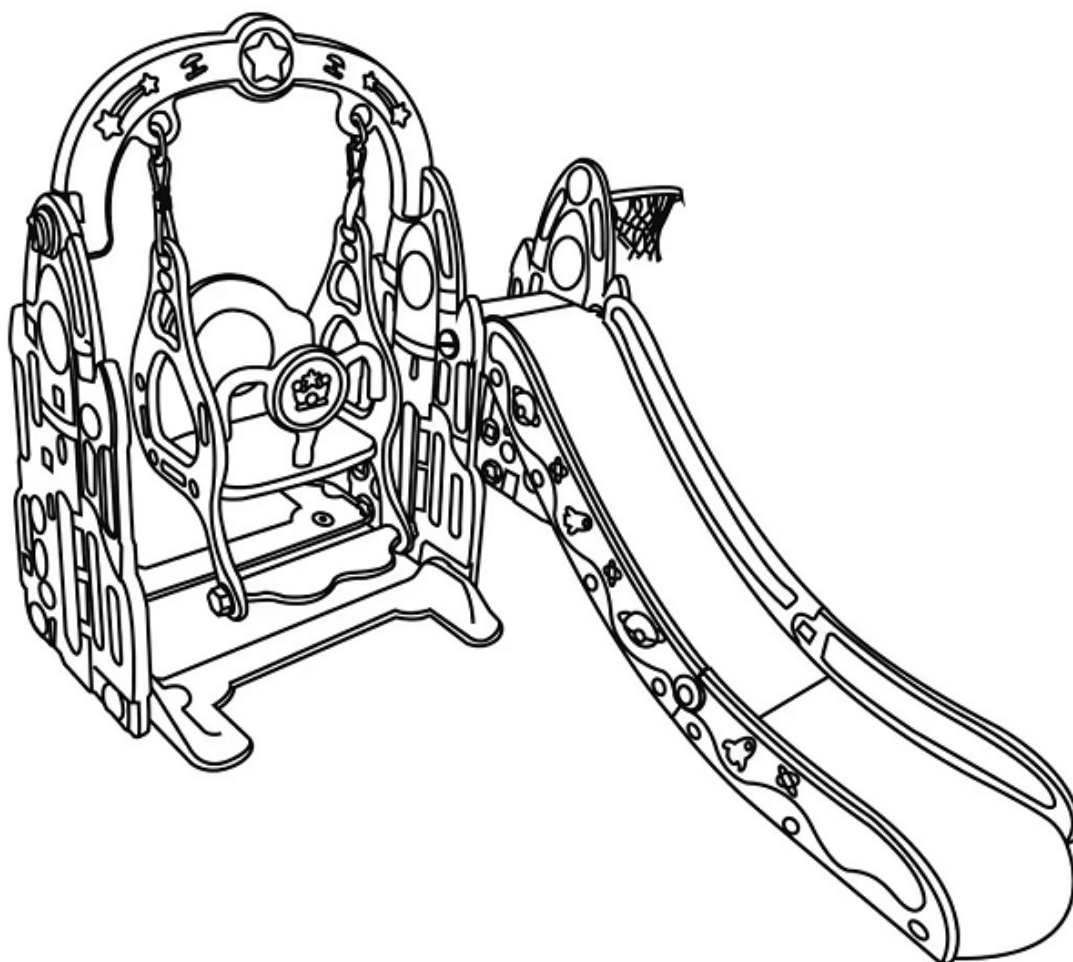

READ AND SAVE THIS INSTRUCTION FOR FUTURE USE

---

# PART LIST

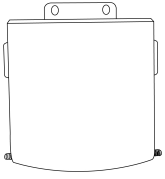

Slide Extension x 1

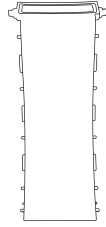

Slide x 1

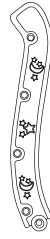

Long Slide Handrail x 2



Short Slide Handrail x 2

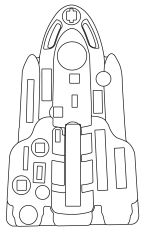

Side Panel x 3

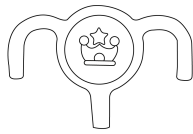

Swing Armrest x 1

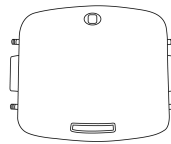

Swing Seat x 1

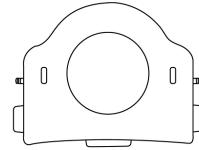

Swing Seat Back x 1

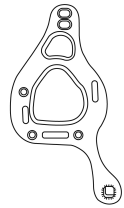

Swing Arm x 2

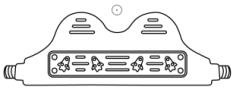

Swing Pedal x 1

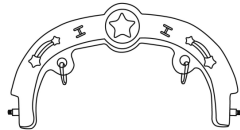

Crown x 1

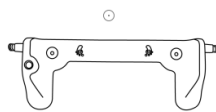

Swing Base x 2

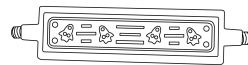

Stair Pedal x 4

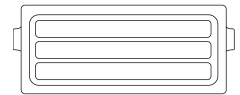

Stair Baffle x 3



Screw A x 21

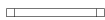

Rope x 2



Screw B x 2

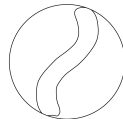

Screwdriver x 1

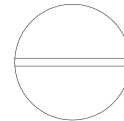

Screw C x 2

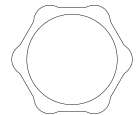

Screw D x 17

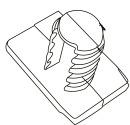

Screw E x 2



Sucker x 4



Buckle x 2

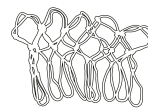

Basketball Net x 1

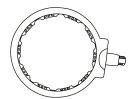

Basketball Ring x 1

# ASSEMBLY

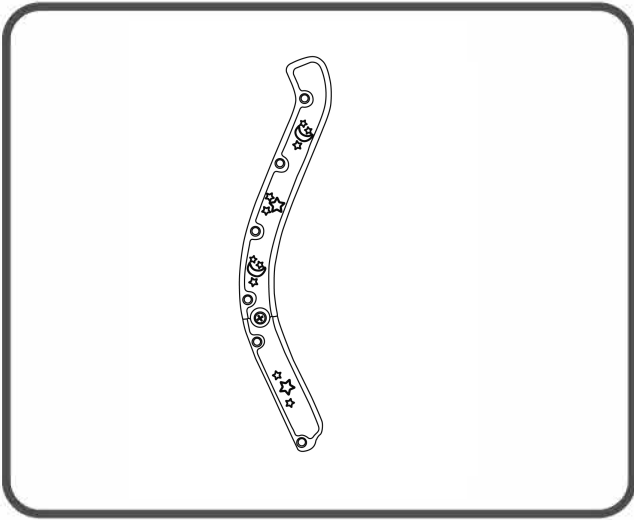

## Step1

Connect the Long Slide Handrail to Short Slide Handrail, secure with 1 Screw B on each side.

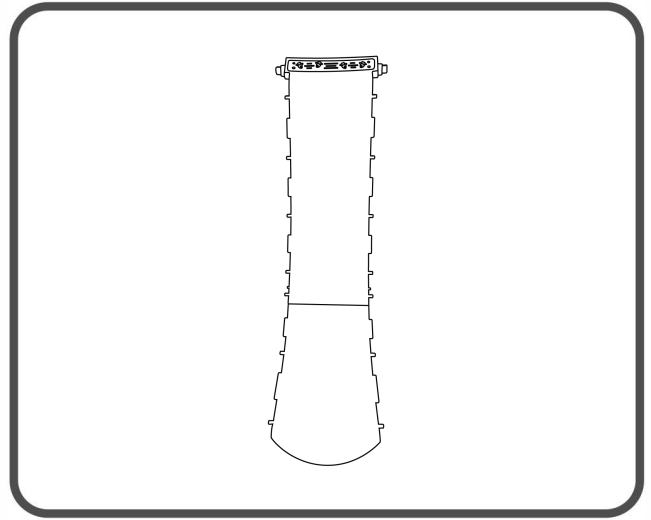

## Step2

Connect the Slide Extension to Slide, secure with 2 Screw E.

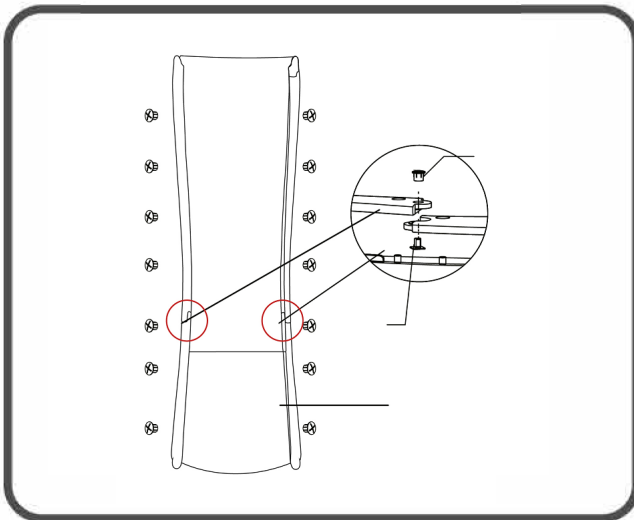

## Step3

Attach the Handrails, secure with 7 Screw A on each side.

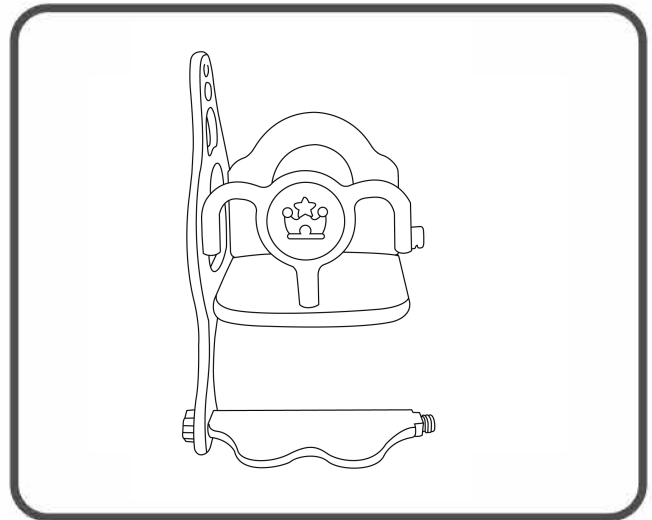

## Step4

Connect the Swing Armrest, Swing Seat, Swing Pedal, Swing Seat Back to the Swing Arm, secure with 4 Screw A, 1 Screw D.

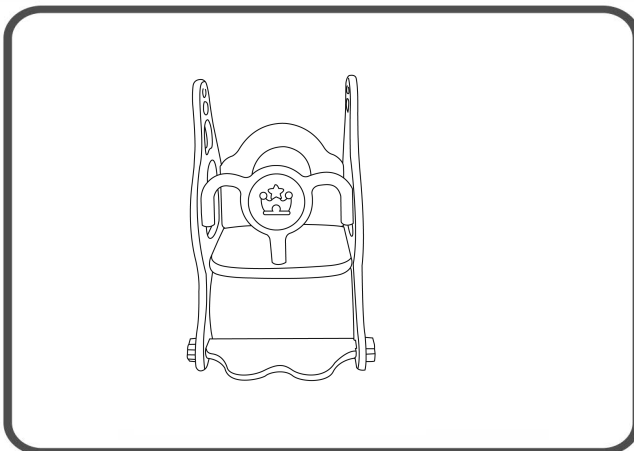

## Step5

Connect Step 4 Assembled parts to the other side panel, secure with 3 Screw A, 1 Screw D.

# ASSEMBLY

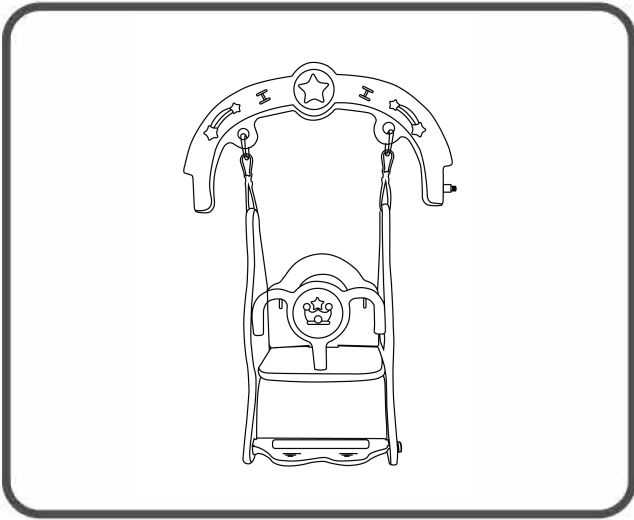

## Step 6

Connect the Swing Arm to the Crown, secure with 2 Buckle and 2 Ropes.

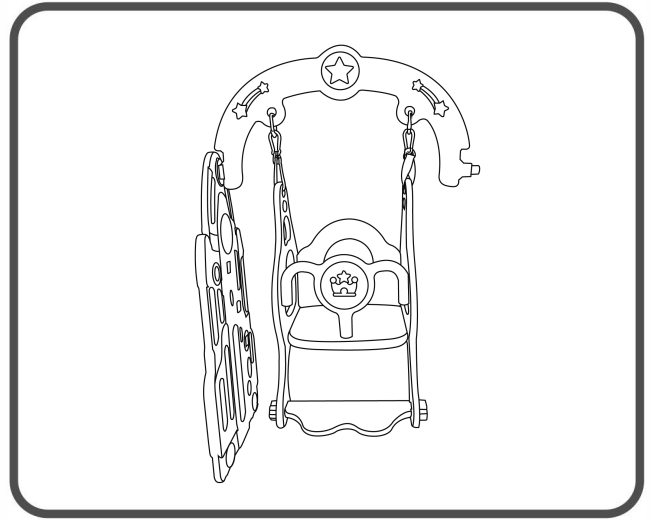

## Step 7

Connect the Crown to the Side Panel, secure with 1 Screw D.

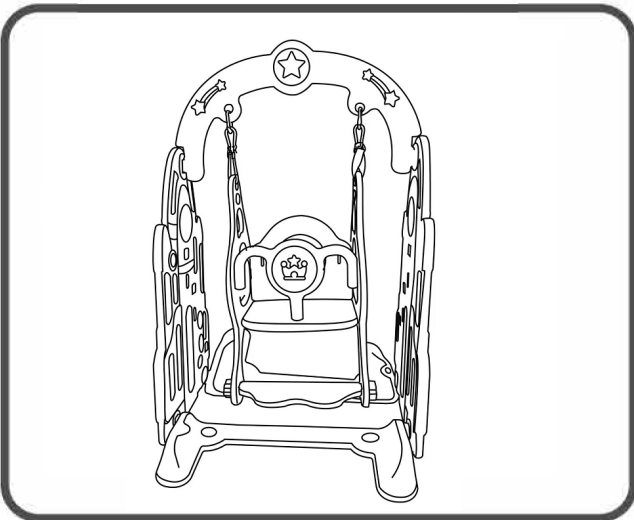

## Step 8

Connect the 2 Swing Base to the Side Panel, secure with 2 Screw D. Then connect the other Side Panel to the assembled parts.

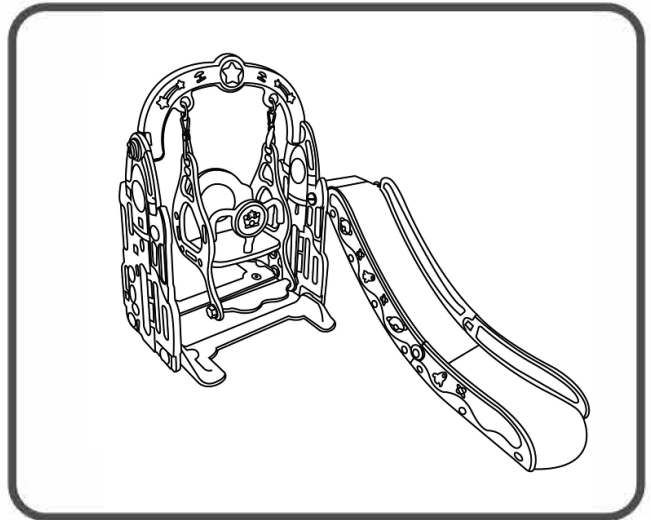

## Step 9

Connect Step 3 Assembled parts to the Step 8 Assembled parts, secure with 1 Screw C.

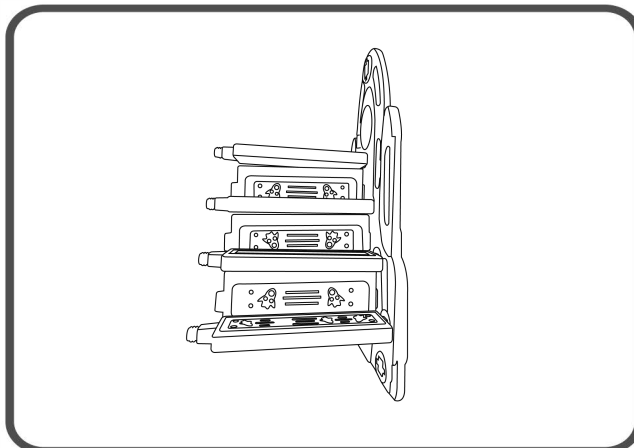

## Step 10

Connect Stair Pedal and Stair Baffle to the Side Panel, secure with 4 Screw D.

# ASSEMBLY

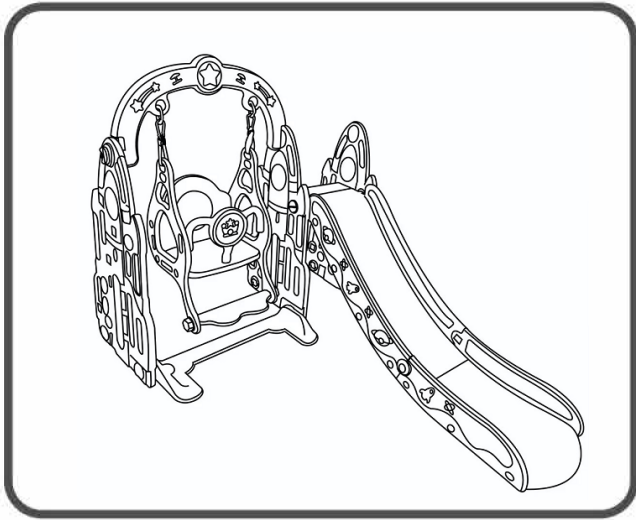

## Step 11

Connect another side panel to the stair and Slide, secure with 4 Screw D & 1 Screw C.

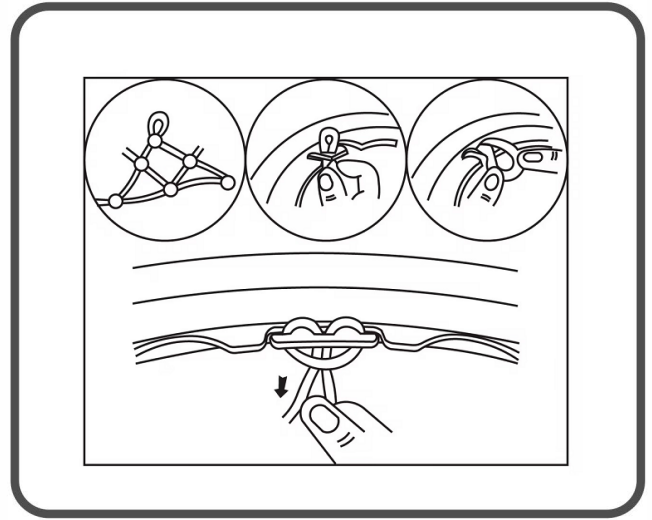

## Step 12

Connect the Basketball Net to the Basketball Ring.

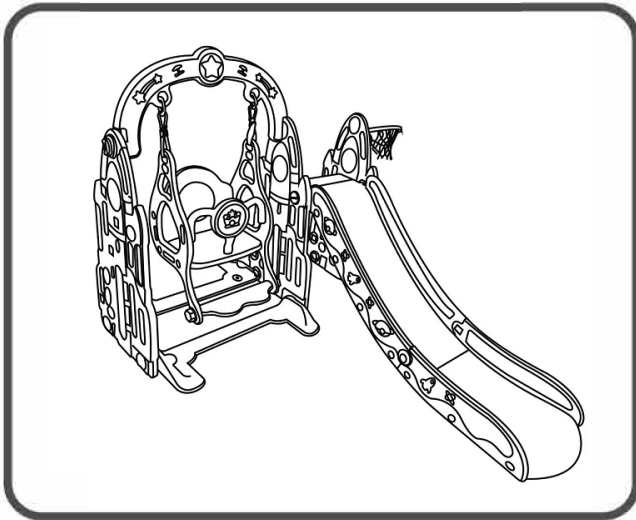

## Step 13

Connect the Basketball Ring to the Side Panel, secure with 1 Screw D.  
Then attach the Suckers to the bottom of the product to keep it stable.



## GENERAL SAFETY INSTRUCTIONS

This product is intended for indoor, outdoor, home, domestic use only. It is not suitable for commercial or medical use.

The assembly of the product must be done carefully and by an able-bodied adult. If in any doubt, ask a technically qualified person.

Do not use the product if it is damaged or defective. If it is damaged or defective, please contact a qualified technician.

Check the product before each use. Defective parts must be changed immediately as they can impair the function and the safety of the product.

Use the product only on even and non-slip surfaces. Keep sufficient space around for safety.

Beware that when using tools or doing technical work, there is always a risk of injuries. Assemble the product with care.

After installing the product according to the instruction manual, ensure all screws, bolts and nuts are correctly installed and tightened and that all joints are secure.

Do not make alterations to the product. Only use original spare parts. Only qualified technicians should carry out repairs - improper repairs can lead to danger for the user. Use this product only as described in this manual.

## IMPORTANT

The owner's manual contains safety, assembly, use and maintenance instructions. The product must be assembled by an adult who has read and understood these instructions. Keep the packaging away from children and dispose of all packaging before use.

## OPERATION INSTRUCTIONS

Provide adult supervision at all times.

The disassembled product contains small parts which pose a choking hazard to children under 3.

Dress children appropriately, including wearing well-fitting shoes that fully protect feet.

Instruct children:

- to sit in the center of the swings with their full weight on the seats,
- to avoid swinging empty seats,
- to slide feet first; one child down slide at a time,
- to remove articles, before playing on equipment, that create hazards when they get tangled and caught.
- not to walk close to, in front of, behind, or between moving items,
- not to get off equipment while it is in motion.

Never allow children to use the equipment in a manner other than intended. Do not swing while standing or slide down head first.