

# ASSEMBLY INSTRUCTION

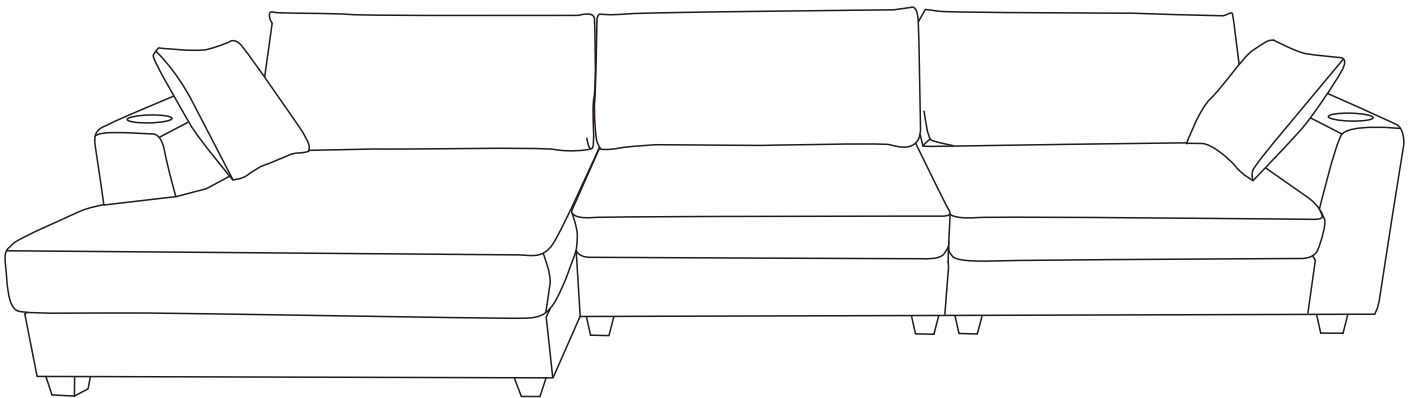



## Return & Warranty policy:

- We strive to offer the highest quality products, and we also try our best to satisfy each and every customer that orders from us with replacement parts or service as needed.
- If the item is damaged or defective, please take photos as evidence for replacements and refunds.
- Please do not return to store, contact the seller if you have any troubles with this product.

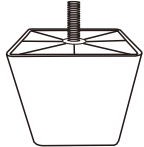
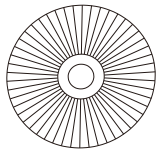
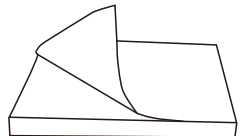

HARDWARE N723P168446 N723P168447 N723P168448

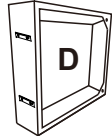
NO	DESCRIPTION	SKETCH	QTY
1	Plastic Legs		15
2	Gasket		15
3	Feet Decals		15

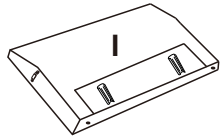
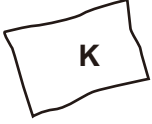

PARTS LIST N723P168440 N723P168441 N723P168442

NO	DESCRIPTION	SKETCH	QTY
D	Seat Frame (middle)		1
F	Cushion		1
I	Backrest (middle)		1
K	Back Cushion		1

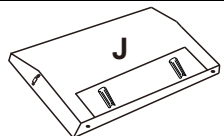
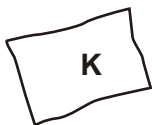

PARTS LIST N723P168443 N723P168444 N723P168445

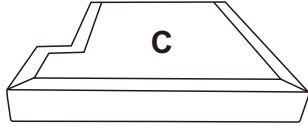
NO	DESCRIPTION	SKETCH	QTY
E	Seat Frame (right)		1
F	Cushion		1
J	Backrest (right)		1
K	Back Cushion		1



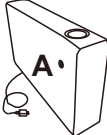
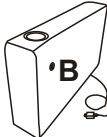

PARTS LIST N723P168446 N723P168447 N723P168448

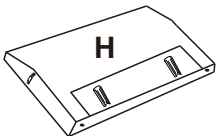
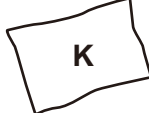
NO	DESCRIPTION	SKETCH	QTY
C	Chaise Longue Frame		1
G	Chaise Longue Cushion		1

PARTS LIST N723P168449 N723P168450 N723P168451

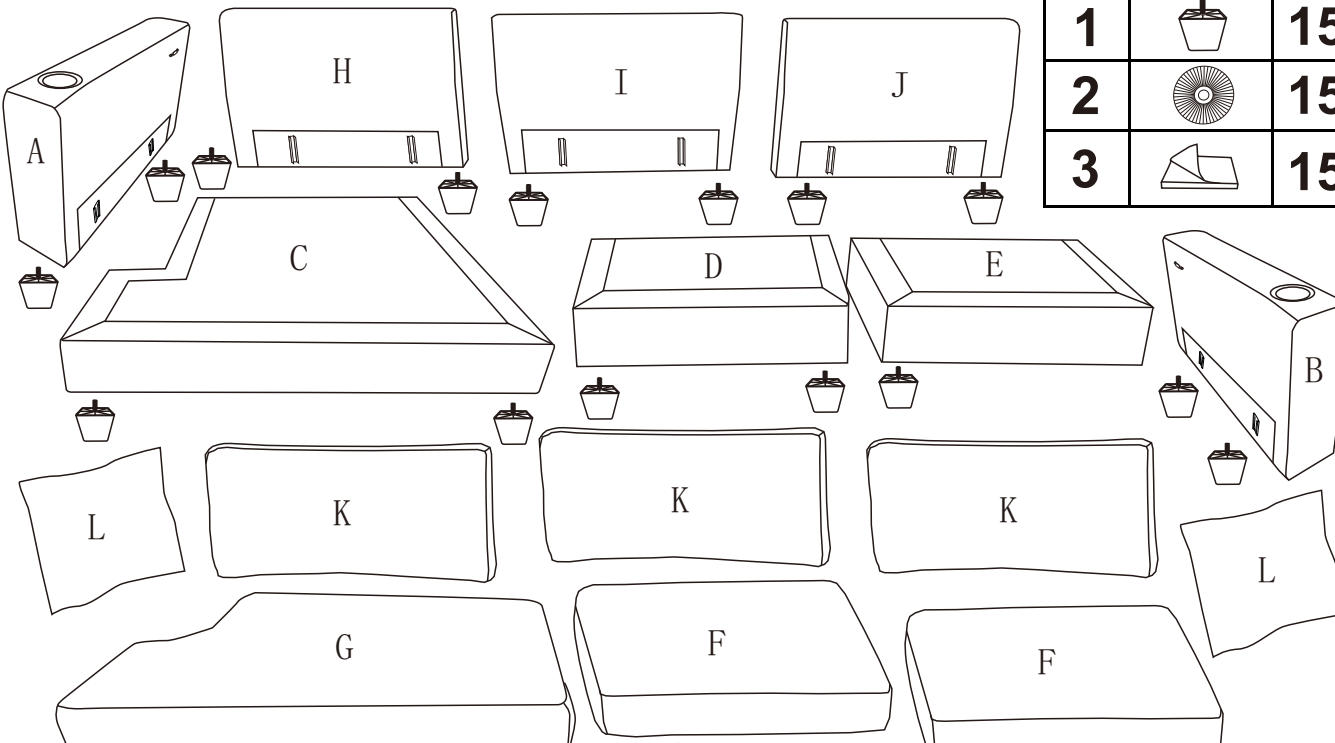
NO	DESCRIPTION	SKETCH	QTY
A	Armrest (left)		1
B	Armrest (right)		1
L	Pillow		2
H	Backrest (left)		1
K	Back Cushion		1

All parts and hardware

	<b>1</b>		<b>15</b>
	<b>2</b>		<b>15</b>
	<b>3</b>		<b>15</b>

**3/8**

## DIAGRAM 1

Take the chaise longue cushion (Part G) out of the Chaise longue frame (Part C);  
 Take the cushions (Part F) out of the seat frames (Part D & Part E);  
 Take the back cushions (Part K) out of the backrests (Part H, Part I, & Part J);  
 Take the pillows (Part L) out of the armrests (Part A & Part B).

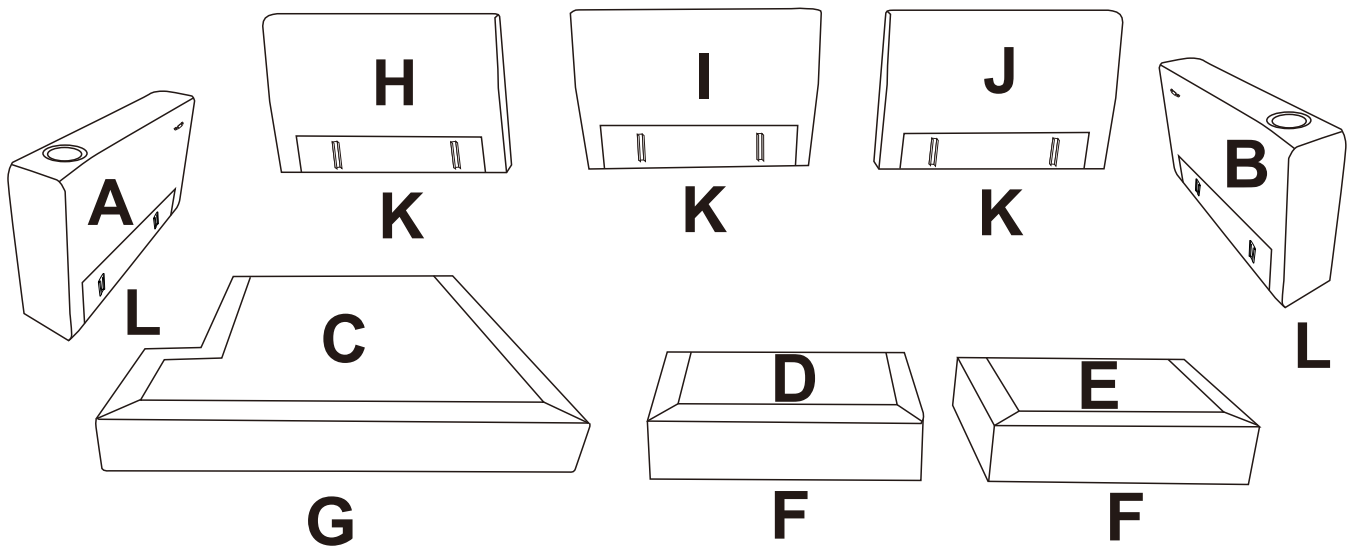

## DIAGRAM 2

Tighten 4 plastic legs (Part 1) with gaskets (Part 2), and stick the feet decals (Part 3) onto each leg.

Connect the seat frame (middle) (Part D) and backrest (middle) (Part I).

1		4
2		4
3		4

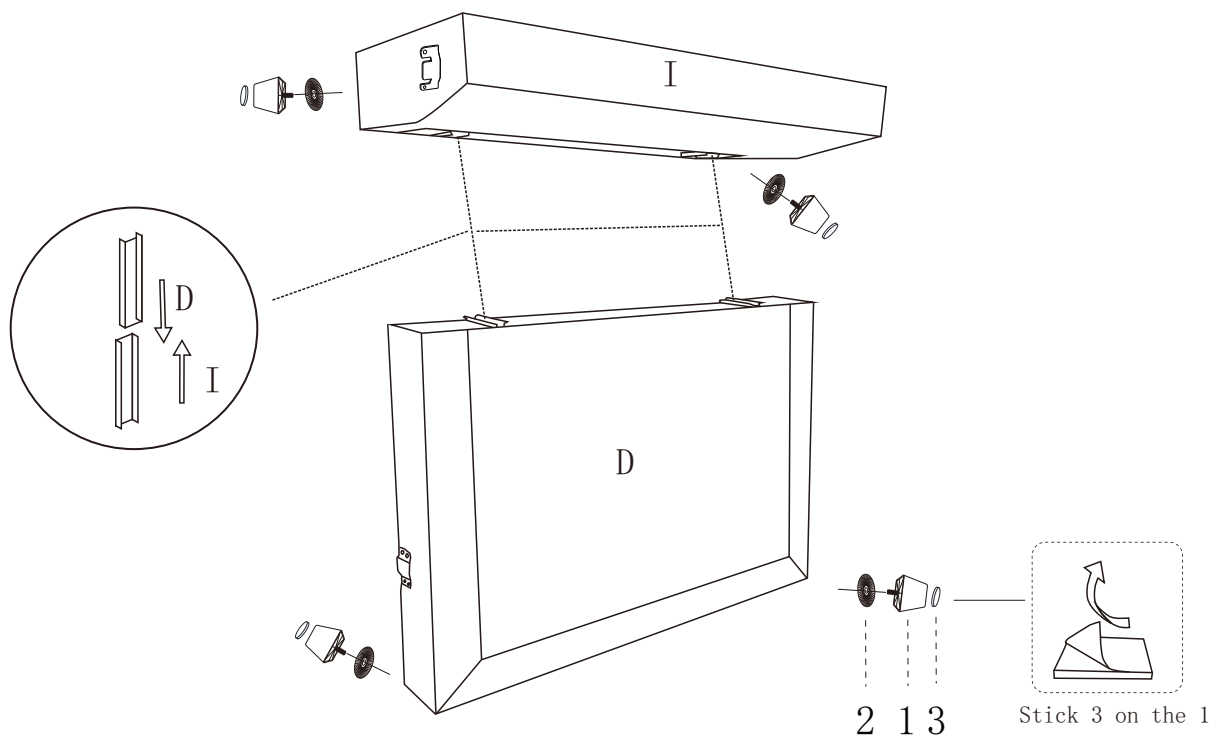

### DIAGRAM 3

Connect the seat frame (right) (Part E) and armrest (right) (Part B);  
Tighten plastic 3 legs (Part 1) with gaskets (Part 2), and stick the feet  
decals (Part 3) onto each leg.

Connect the backrest (right)(Part J) and the seat frame (right) (Part E)  
and the armrest (right) (Part B);  
Tighten plastic 2 legs (Part 1) with gaskets (Part 2), and stick the feet  
decals (Part 3) onto each leg.

1		5
2		5
3		5

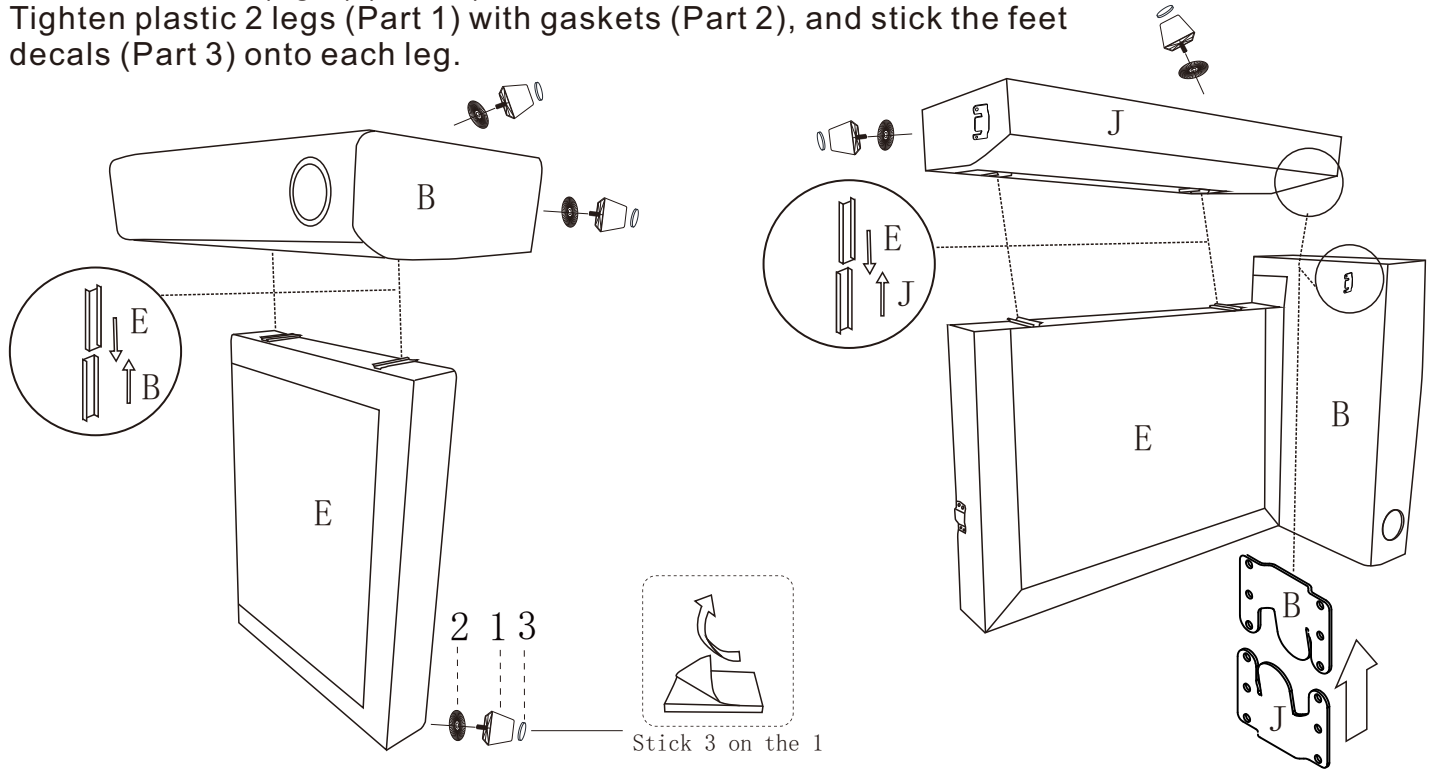

### DIAGRAM 4

Tighten 4 plastic legs (Part 1) with gaskets (Part 2), and stick the feet  
decals (Part 3) onto each leg.

Connect the armrest (left) (Part A) to chaise longue frame (Part C).

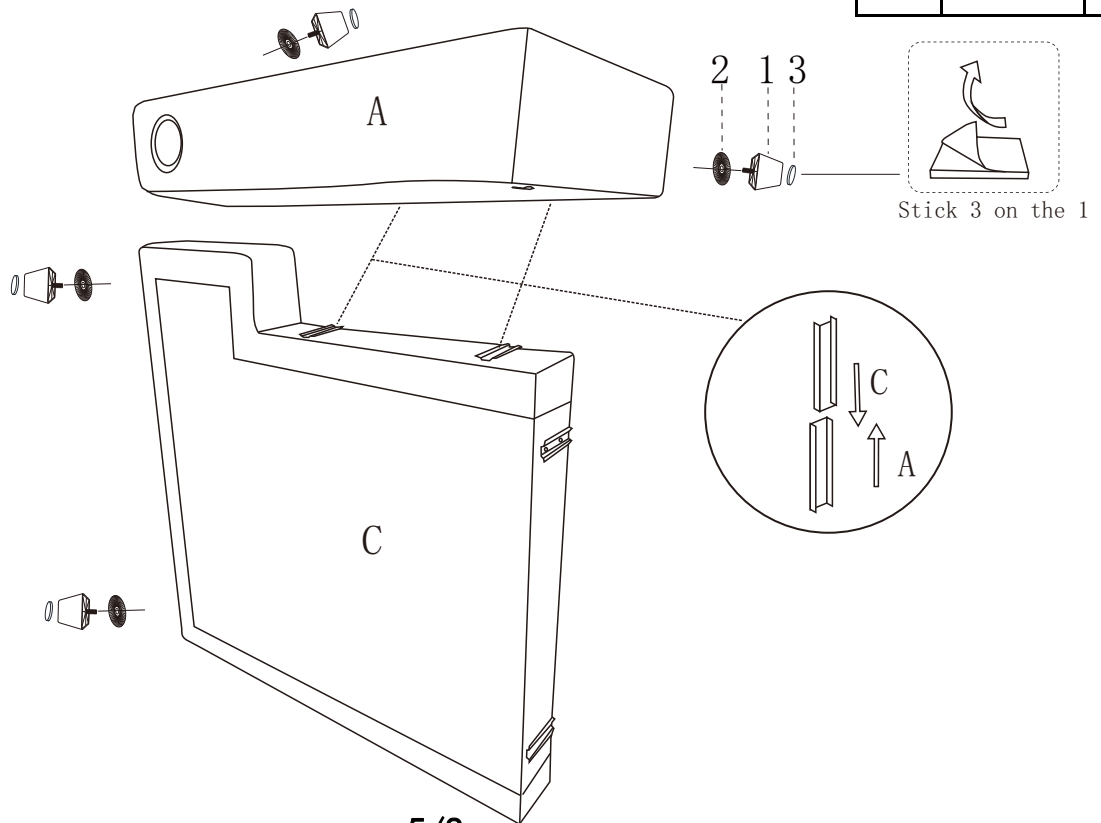

1		4
2		4
3		4



## DIAGRAM 5

Tighten 2 plastic legs (Part 1) with gaskets (Part 2), and stick the feet decals (Part 3) onto each leg.

Connect the backrest (left) (Part H) and the chaise longue frame (Part C) and the armrest (left) (Part A).

1		2
2		2
3		2

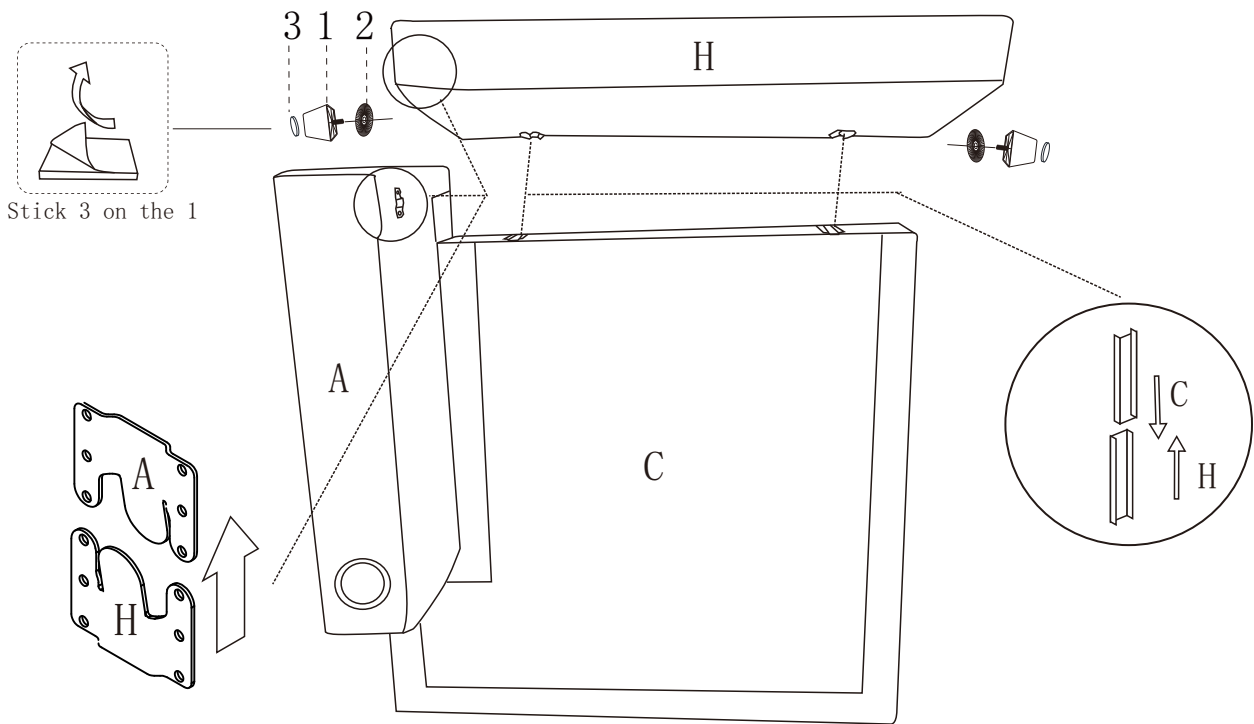

## DIAGRAM 6

Connect the backrest (middle) (Part I) to backrest (left) (Part H).

Connect the seat frame (middle) (Part D) to chaise longue frame (Part C).

Connect the backrest (right) (Part J) to backrest (middle) (Part I).

Connect the seat frame (right) (Part E) to seat frame (middle) (Part D).

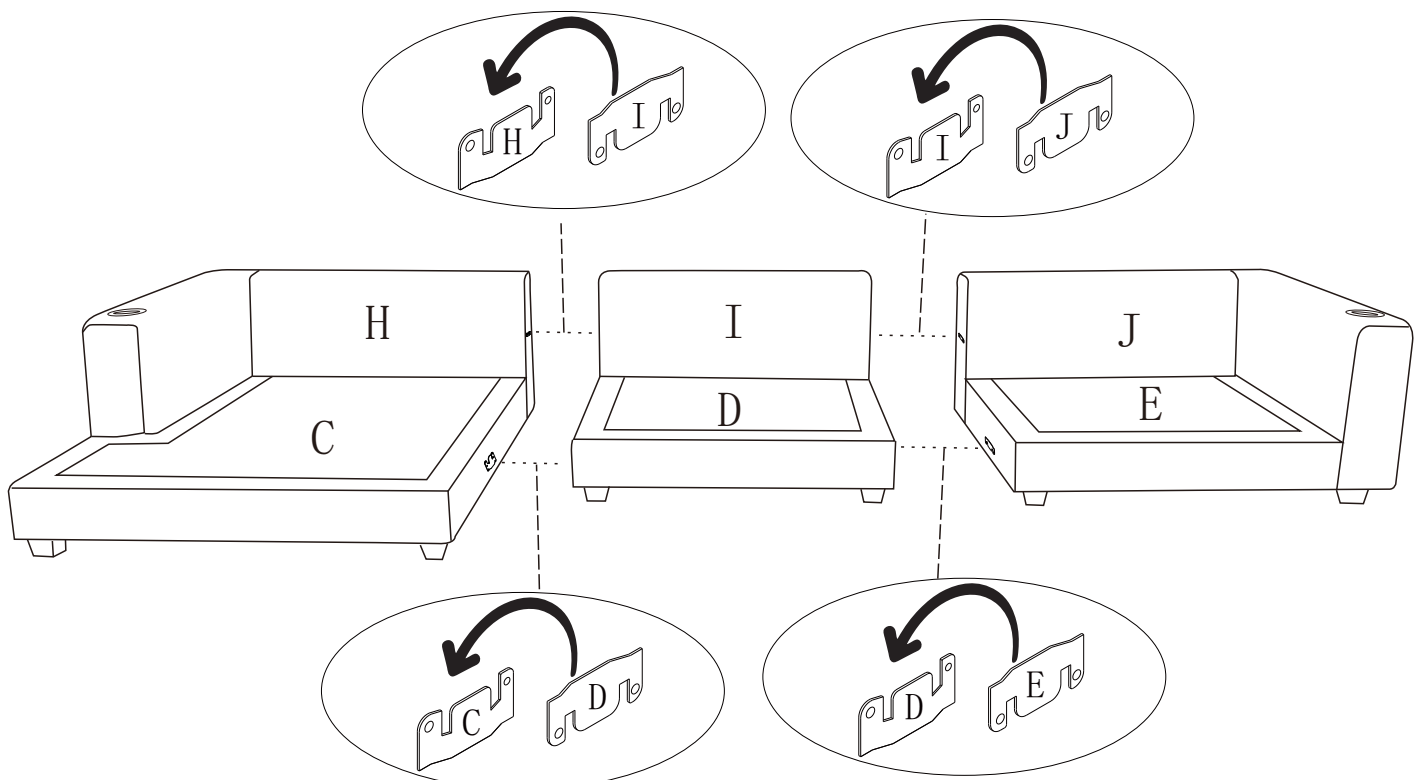

## DIAGRAM 7

Remove the back cushions' plastic bags (Part K and Part L).

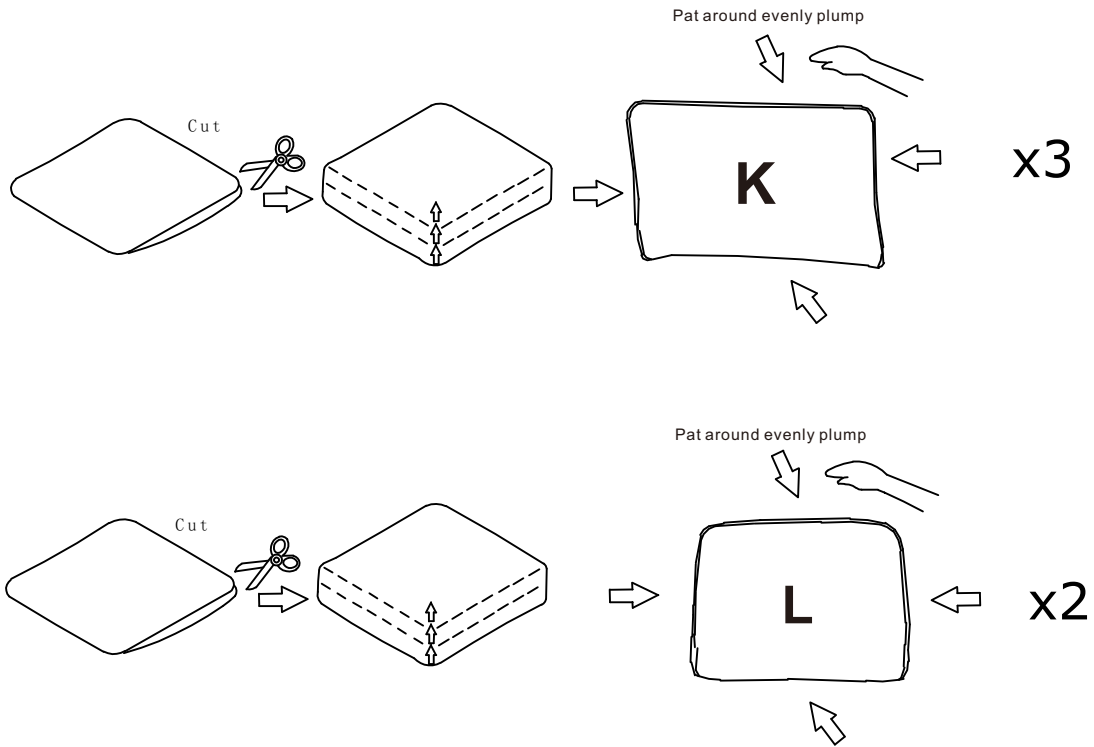

## TIPS

1. Please do not open the compressed packages until your sofa frame is completely assembled.
2. Compressed cushions and back cushions need to be fully fulfilled within 72 hours for your perfect use.
3. Please keep children away from plastic bags or any small pieces of stuff.

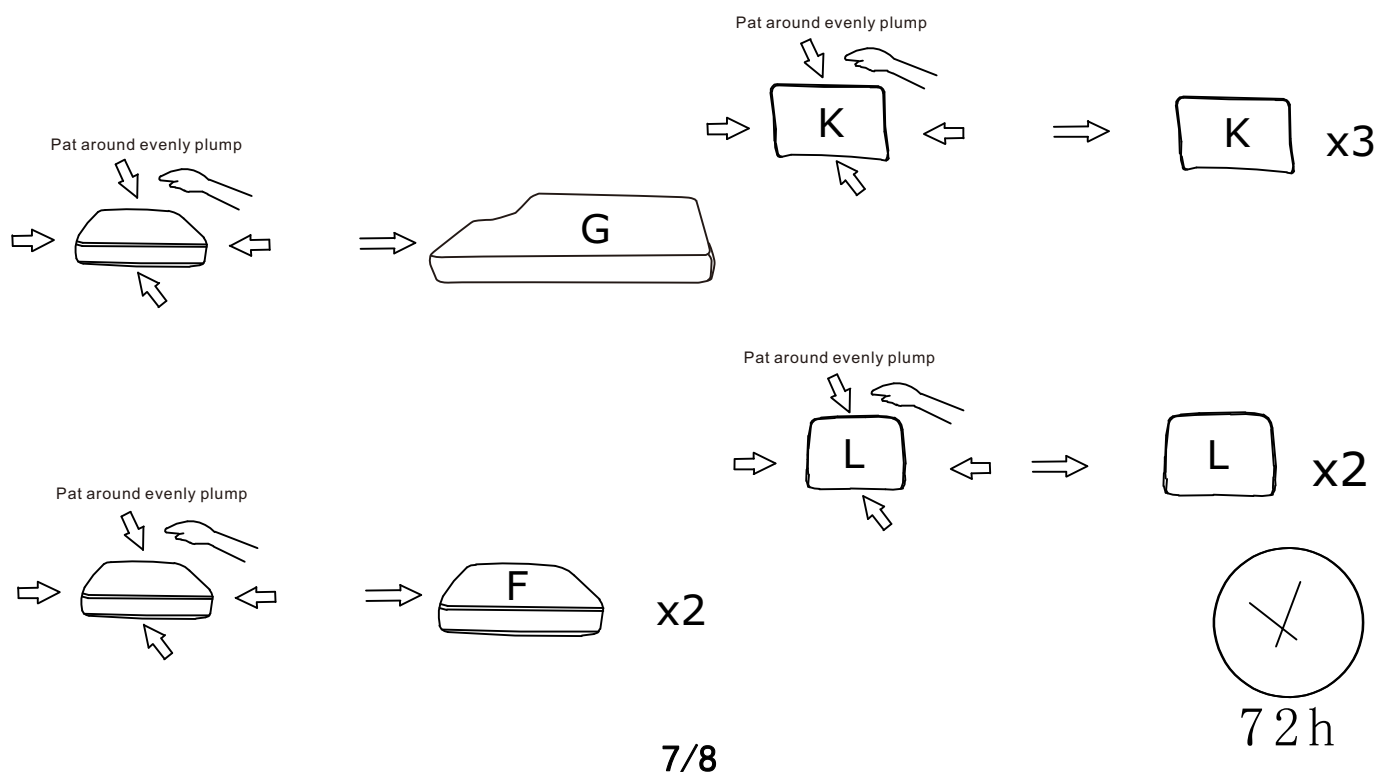

## DIAGRAM 8

Put the Chaise longue cushion (Part G), cushions (Part F) on the sofa.  
Put the Back cushions (Part K) and pillows (Part L) on the sofa.  
Plug in the charger.

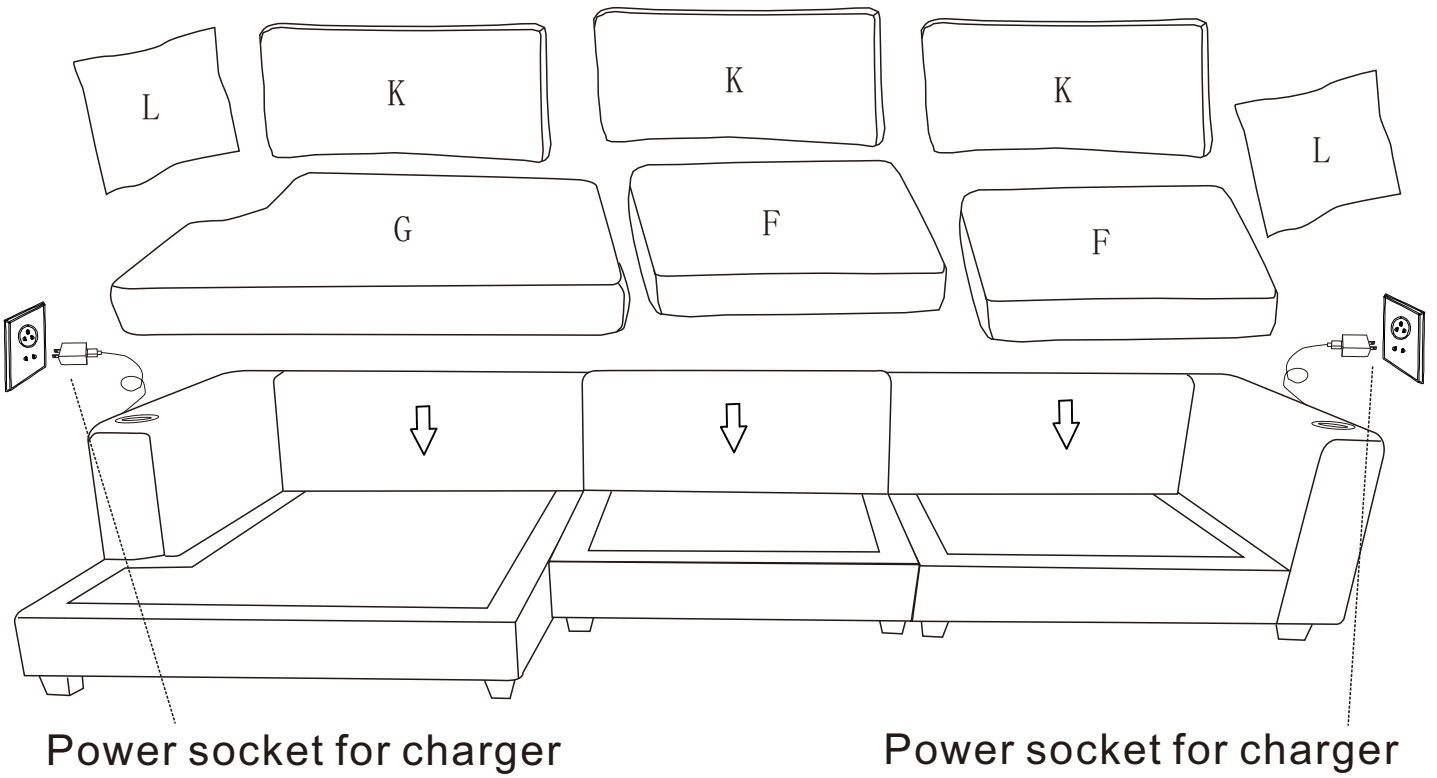

## COMPLETE

