

ASSEMBLY INSTRUCTION

Friendly Reminder:

- 1.This sofa is packed in 2 boxes. Please assemble it After all boxes are received.
- 2.As the cushions are all vacuum compressed,there will be some wrinkles. Please give your cushions up to 72 hours to reach its original size and the wrinkles will basically disappear.
- 3.Please do not open the compressed packags until your sofa frame is completely assembled.

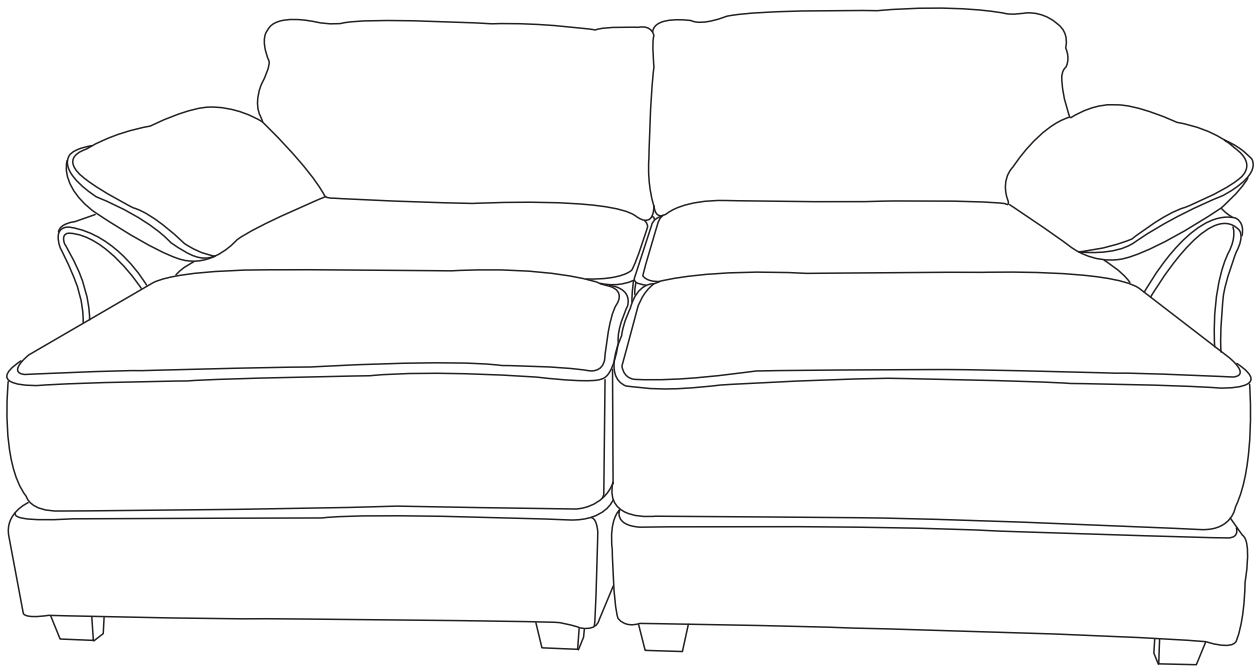





Return & Warranty policy:

- We strive to offer the highest quality products,and we also try our best to satisfy each and every customer that orders from us with replacement parts or service as needed.
- If the item is damaged or defective, please take photos as evidence for replacements and refunds.
- Please do not return to store,contact the seller if you have any troubles with this product.

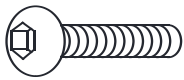
ASSEMBLY INSTRUCTION

HARDWARE



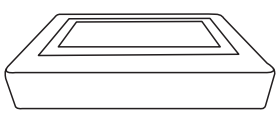
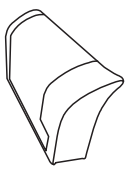
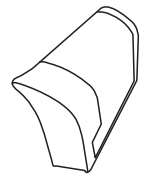
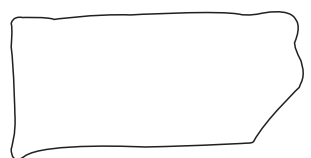
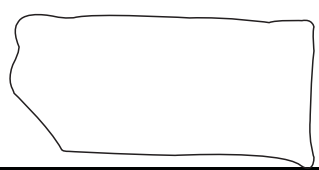
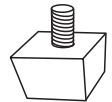

| NO | DESCRIPTION | SKETCH | QTY |
|----|-------------|--|-----|
| 1 | Screws 8X35 |  | 16 |
| 2 | Washer |  | 16 |
| 3 | Gasket |  | 16 |
| 4 | Wrench |  | 1 |

PARTS LIST WF532448

| NO | DESCRIPTION | SKETCH | QTY |
|----|---------------------|--|-----|
| C | Ottoman frame |  | 2 |
| D | Armrest (right) |  | 1 |
| E | Armrest (left) |  | 1 |
| I | Back cushion(right) |  | 1 |
| J | Back cushion (left) |  | 1 |
| M | Leg |  | 16 |

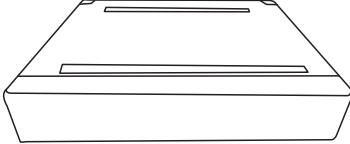
ASSEMBLY INSTRUCTION

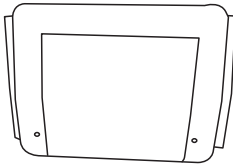
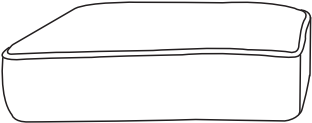
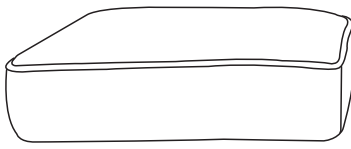
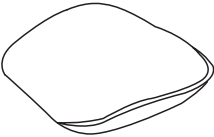
PARTS LIST WF532449

| NO | DESCRIPTION | SKETCH | QTY |
|----|--------------------|--|-----|
| A | Seat frame (right) |  | 1 |
| B | Seat frame (left) |  | 1 |
| F | Back frame |  | 2 |
| G | Seat cushion |  | 2 |
| H | Ottoman cushion |  | 2 |
| K | Armrest bag(right) |  | 1 |
| L | Armrest bag(left) |  | 1 |

All parts and hardwares

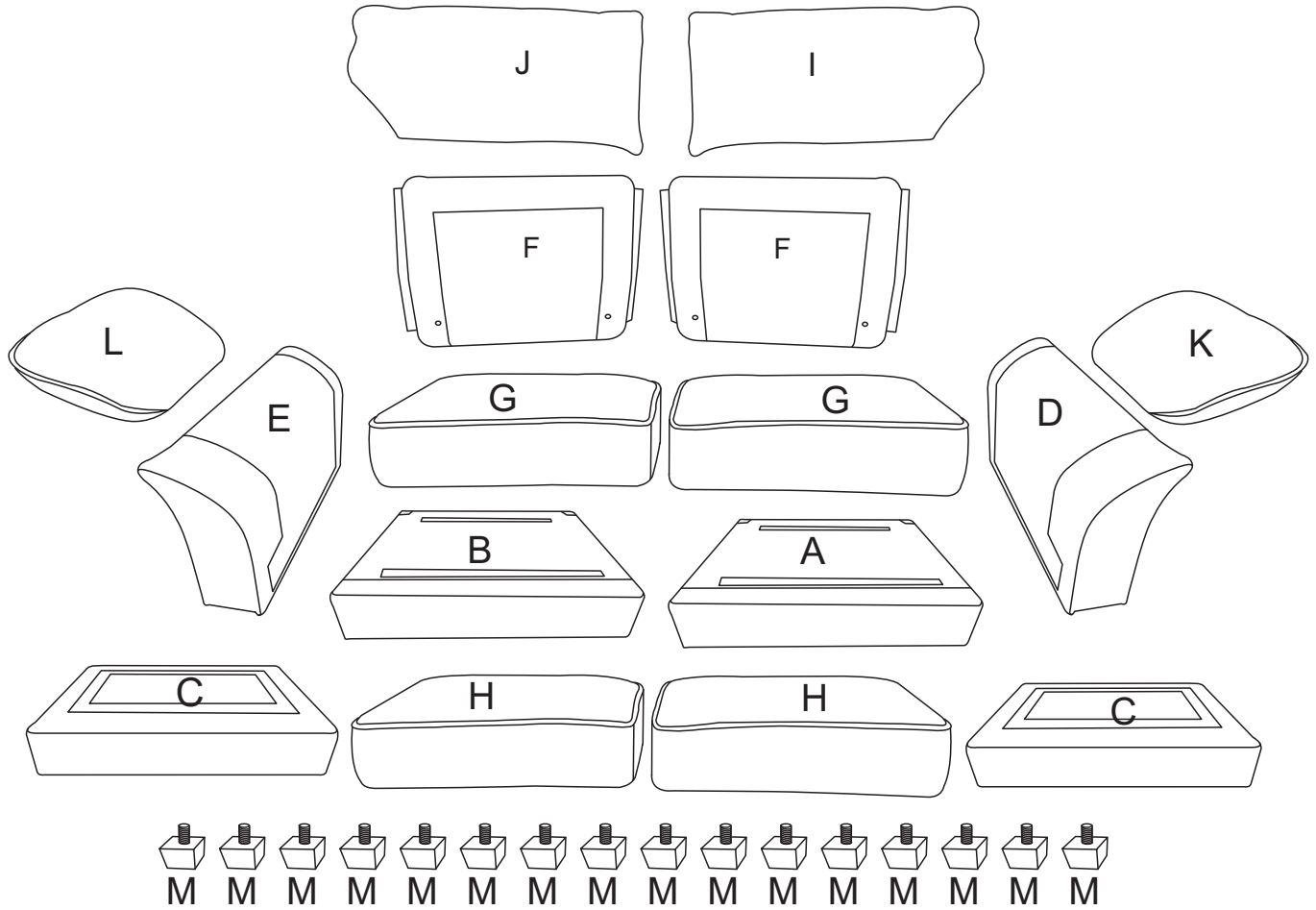

DIAGRAM1(Take out all parts)
 Take the Armrest(right)(Part D),Armrest(left)(Part E), Back cushion(right) (Part I),
 Back cushion(left) (Part J),Legs(Part M) out of the Ottoman frames(Part C).
 Take the Back frames(Part F),Seat cushions(Part G),Ottoman cushions(Part H),
 Armrest bag(right)(Part K),Armrest bag(left)(Part L)out of the Seat frames(Part A&B).

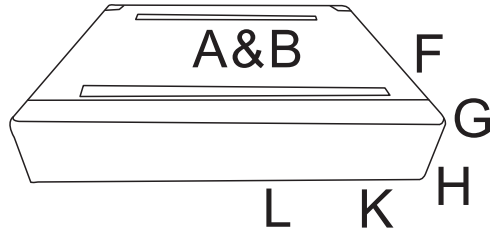
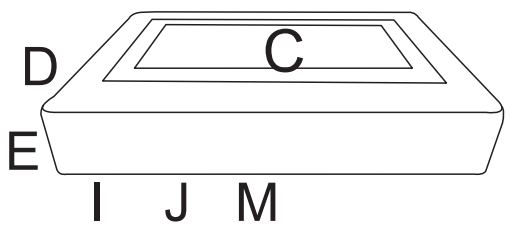





DIAGRAM 2 (Assemble the Armrest(left) to the Seat frame (left))
 Connect the Armrest(left)(Part E) to the Seat frame(left) (Part B) with
 the Screws M8X35mm (Hardware 1) and the Washers (Hardware 2) by
 Wrench (Hardware 4).

| | | |
|---|---|------|
| 1 |  | 4PCS |
| 2 |  | 4PCS |
| 4 |  | 1PCS |

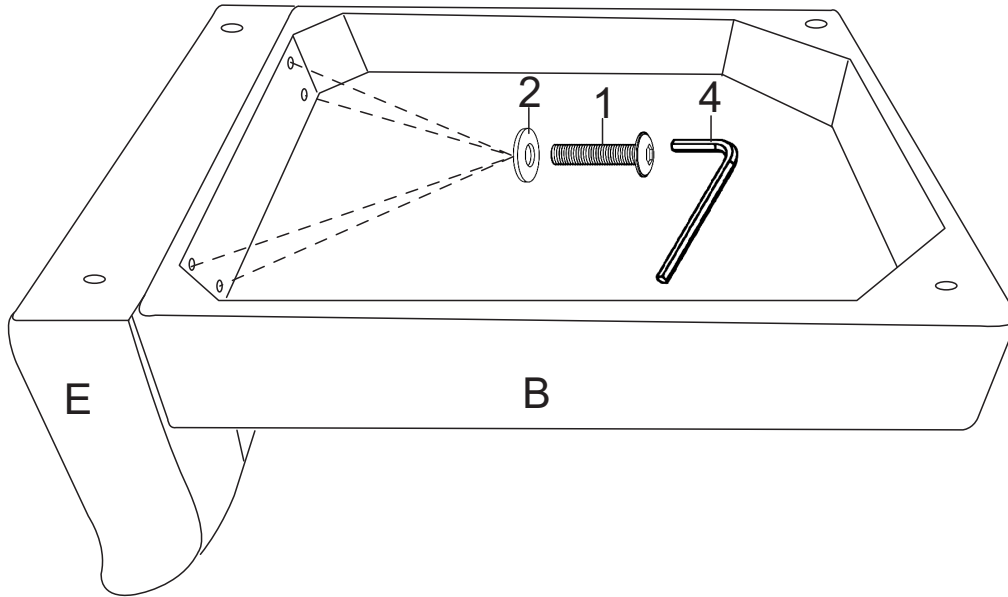





DIAGRAM 3(Assemble the Armrest(right) to the Seat frame(right))
 Connect the Armrest(right)(Part D) to the Seat frame(right) (Part A) with
 the Screws M8X35mm (Hardware 1) and the Washers (Hardware 2) by
 Wrench (Hardware 4).

| | | |
|---|---|------|
| 1 |  | 4PCS |
| 2 |  | 4PCS |
| 4 |  | 1PCS |

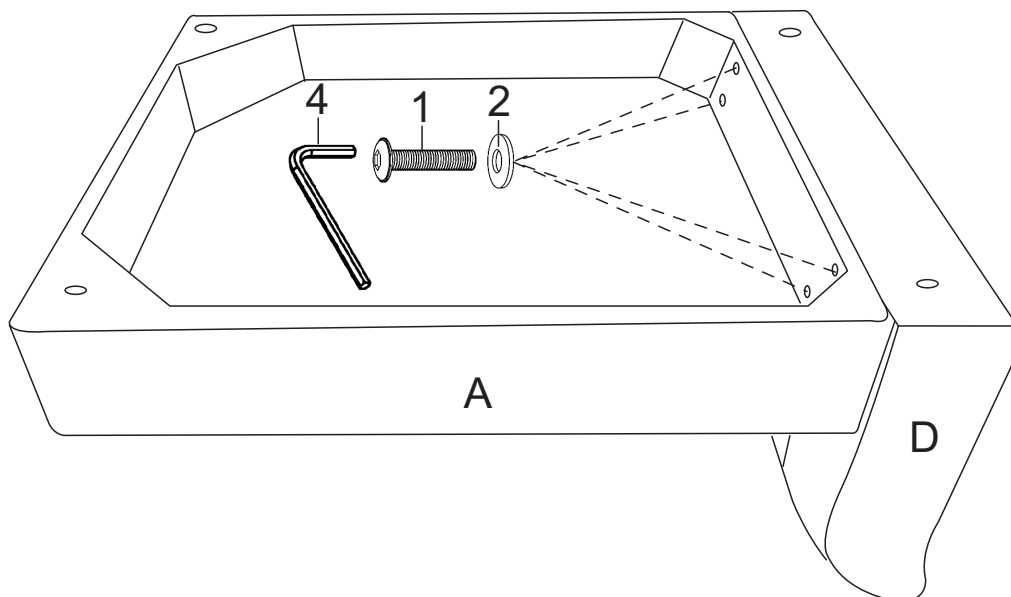



DIAGRAM4 (Assemble the Legs)

| | | |
|---|---|-------|
| 3 |  | 16PCS |
| M |  | 16PCS |

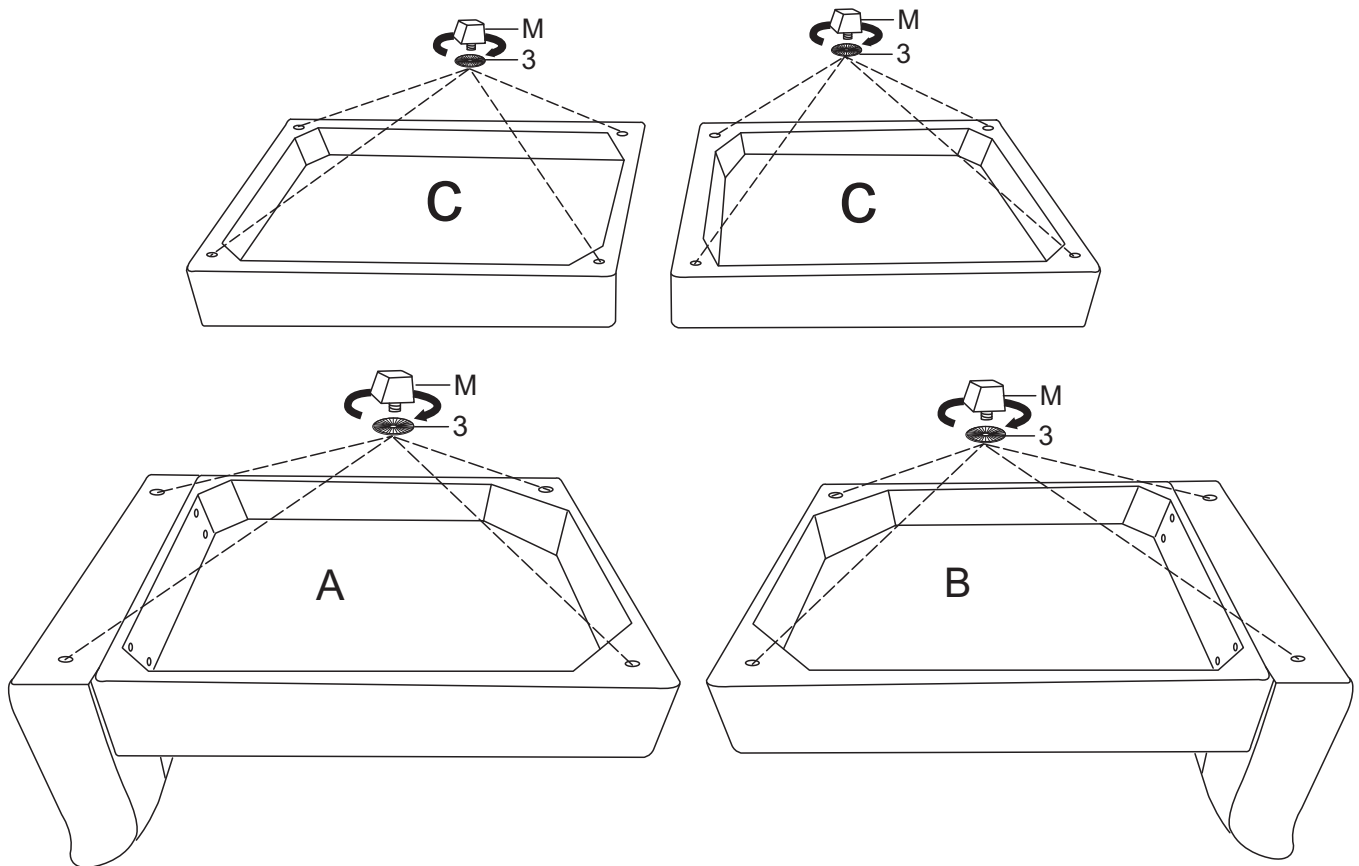





DIAGRAM 5 (Assemble the Back frames)

Connect the Back frames (Part F) by Screws M8x35mm(Hardware1) and Washers (Hardware2) by Wrench(Hardware4) as shown. Then put Velcro pieces together.

Please install the top Screws first, then the bottom Screws.

Make sure all the Screws are in the holes before tightening them.

| | | |
|---|---|------|
| 1 |  | 8PCS |
| 2 |  | 8PCS |
| 4 |  | 1PCS |

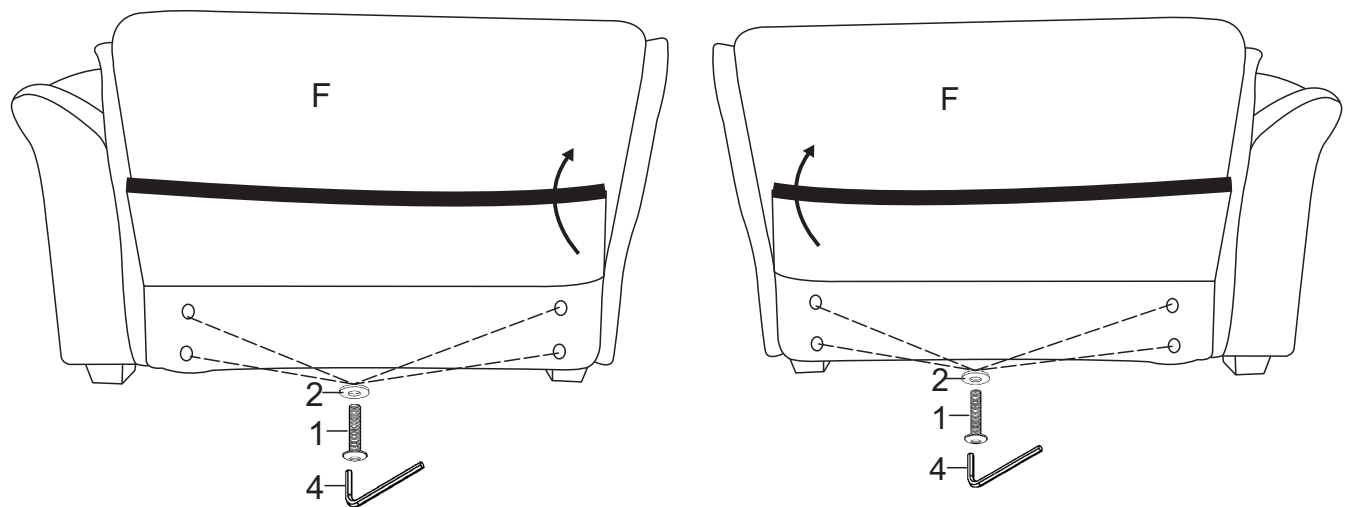

DIAGRAM6 (Connecting the Seat frames)

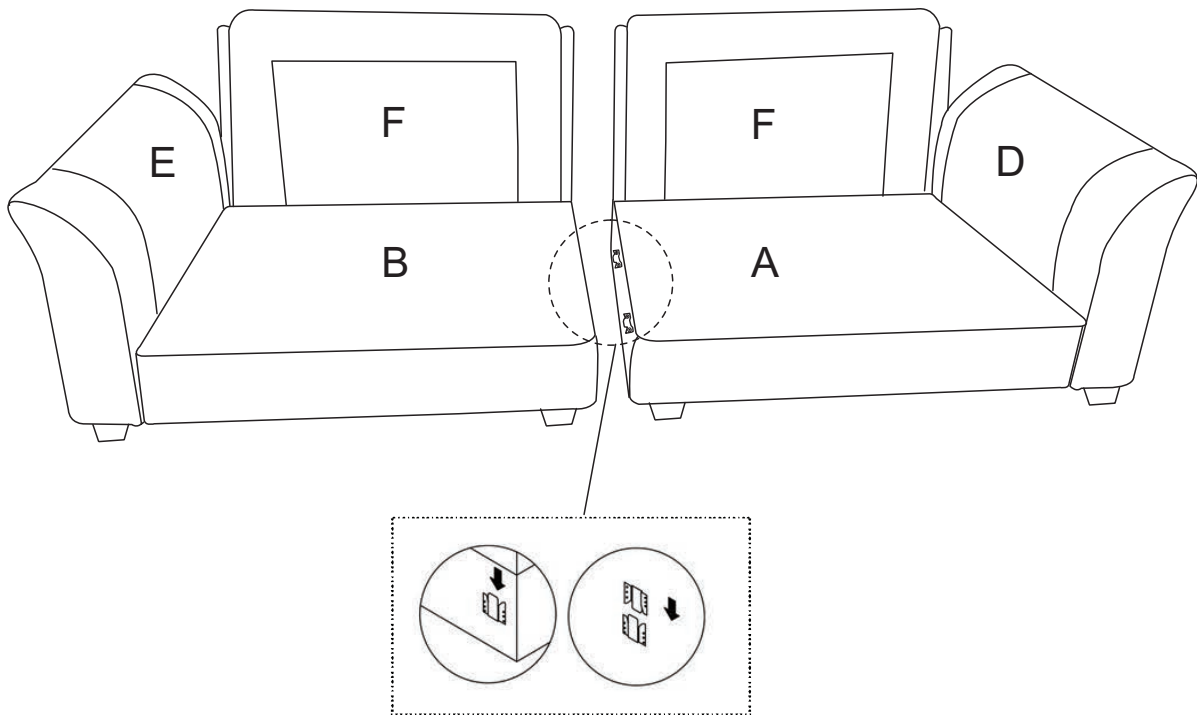

DIAGRAM 7 (Connecting the Armrest bags)
Attach K and L to D and E with zippers.

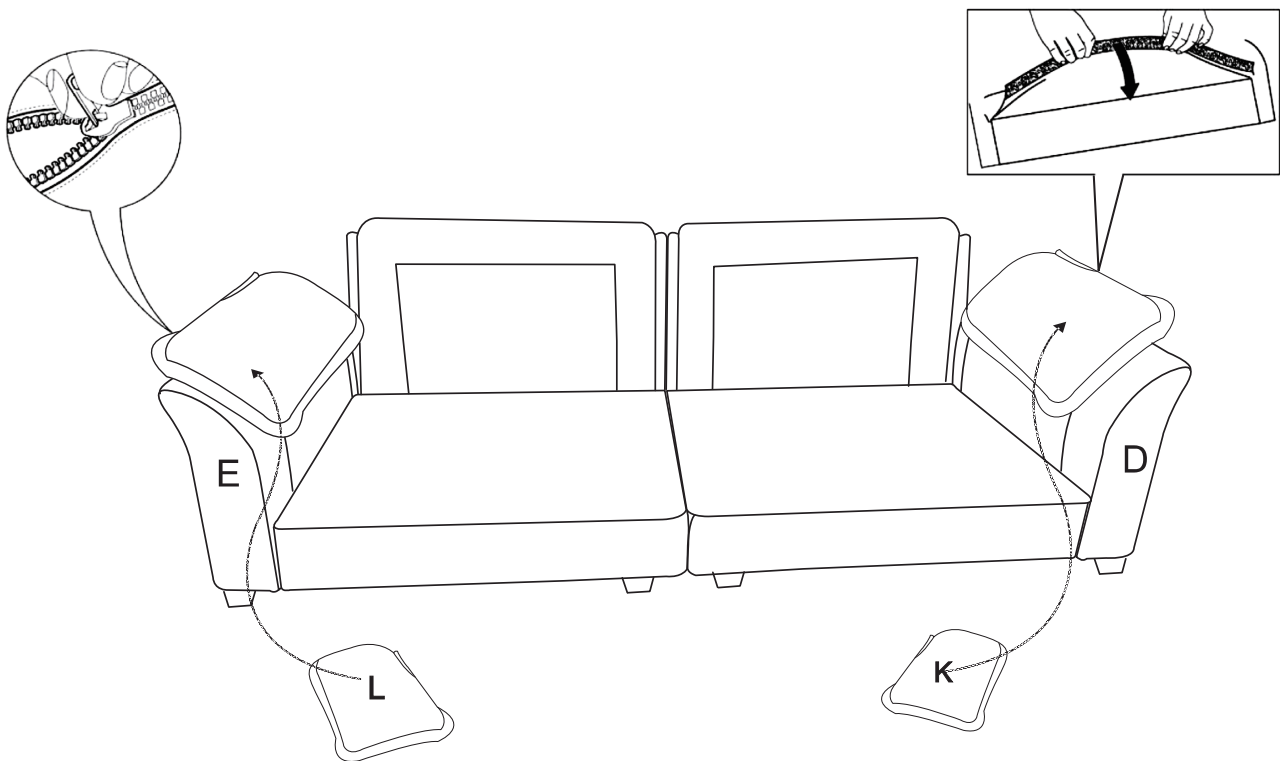

DIAGRAM8 (Removal of compressed bags)

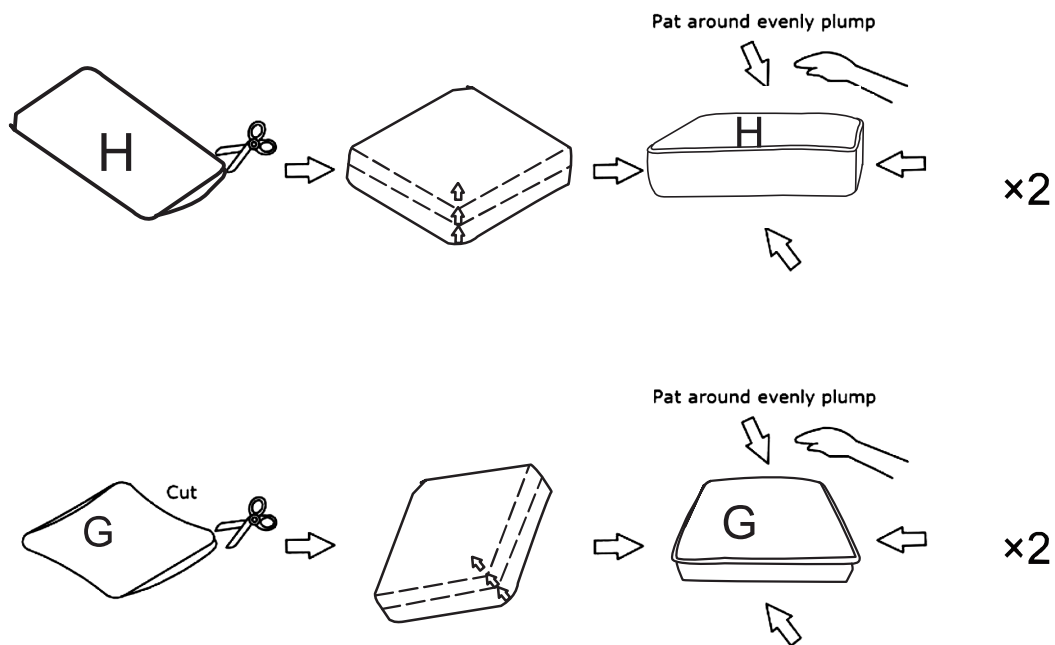
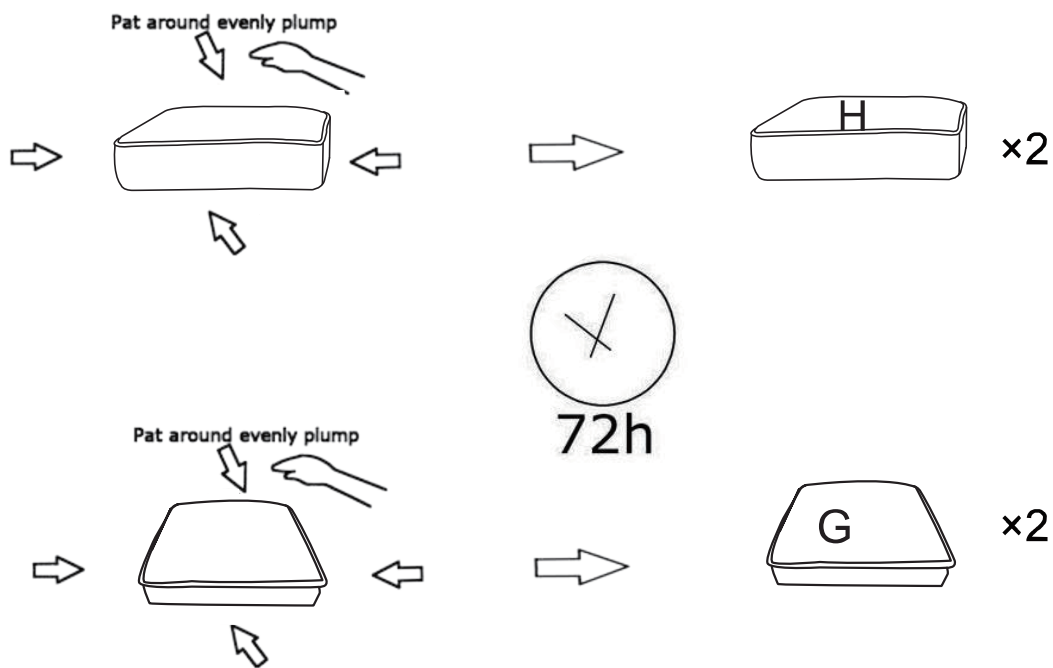

DIAGRAM9 (Waiting for 72H)



TIPS:

1. Please do not open the compressed packages until your sofa frame is completely assembled.
2. Compressed Back cushions and Seat cushions need to be fully fulfilled within 72 hours for your perfect use.
3. Please keep children away from plastic bags or any small pieces of stuff.

DIAGRAM 10 (Place cushions on the sofa)

Tear off the Velcro protective cloth, then put the Ottoman cushions(Part H) the seat cushions(Part G) and the Back cushions(Part I&J) on the sofa.
Recheck all the bolts before you sit on the sofa.

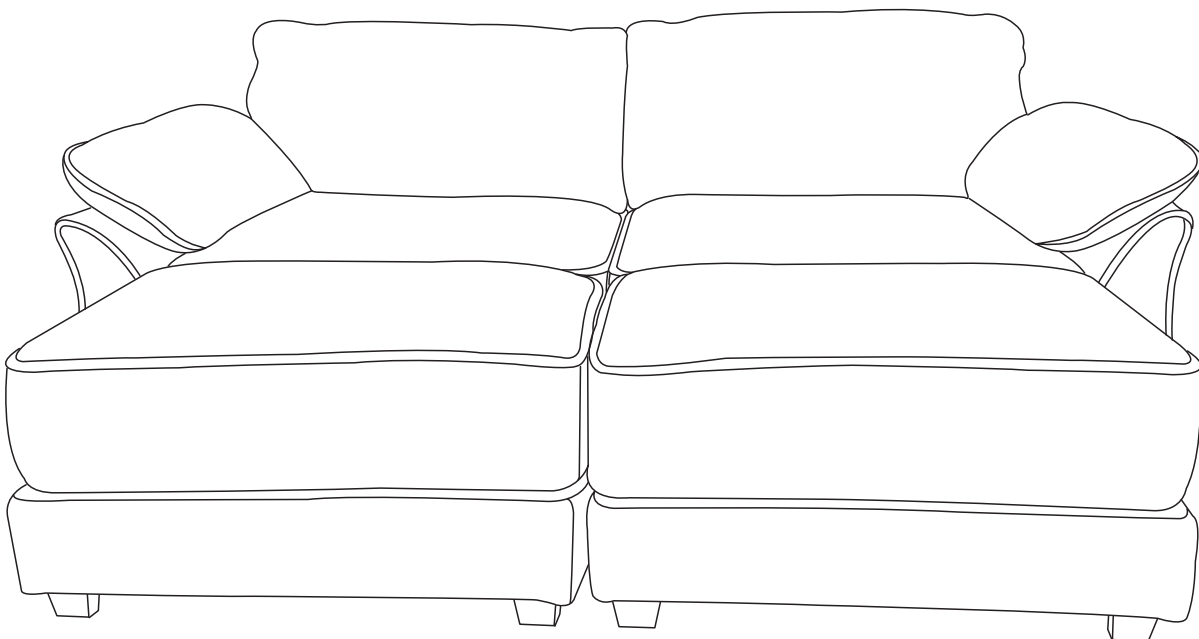
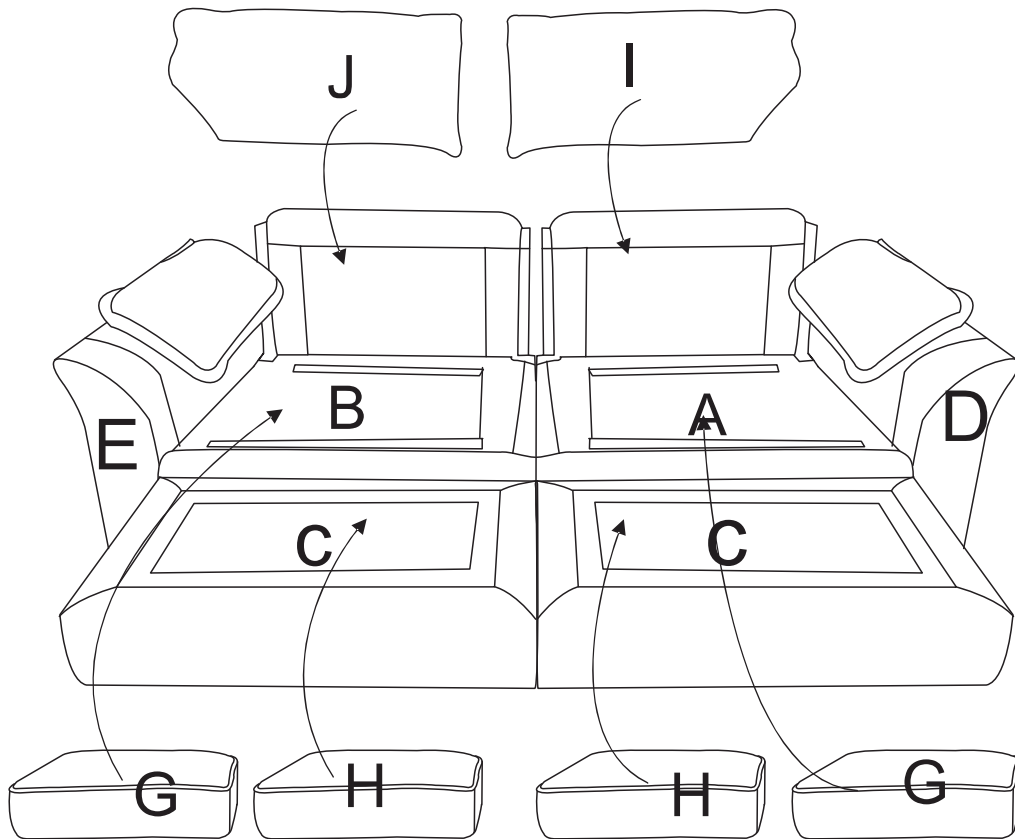

COMPLETE