

# Assembly Instructions

Caution : You must read this before you proceed

## END TABLE

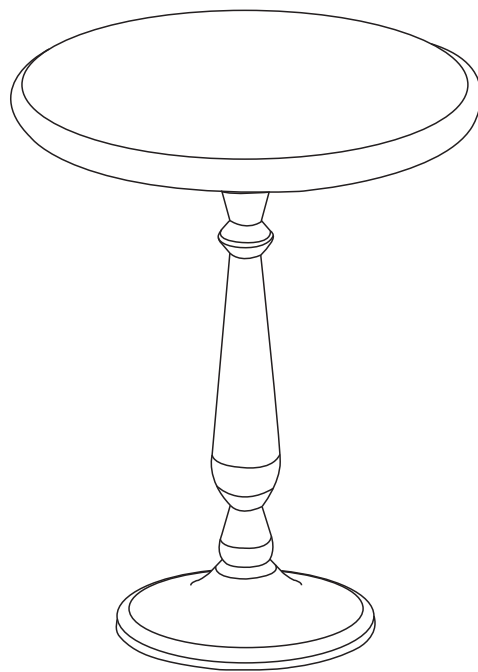

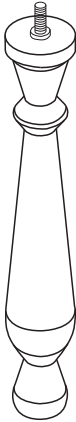
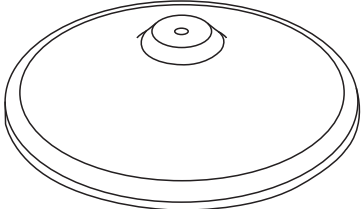

### Part list

| Label | Picture  | Description | QTY |
|-------|--|-------------|-----|
| A     | A line drawing of the table top part. It is a circular disc with a slightly raised edge. In the center, there is a small, cylindrical protrusion with a hole through its center. | TABLE TOP   | 1   |

| Label | Picture  | Description | QTY |
|-------|--|-------------|-----|
| B     |   | MIDDLE PART | 1   |
| C     |  | BASE        | 1   |

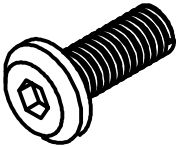
## Hardware

| Label | Picture   | Description                 | QTY |
|-------|---|-----------------------------|-----|
| ①     |  | Flat Head Allen Bolt (19mm) | 2   |
| ②     |  | Allen Wrench (5mm)          | 1   |

## Assembly preparation

Before  
beginning  
assembly

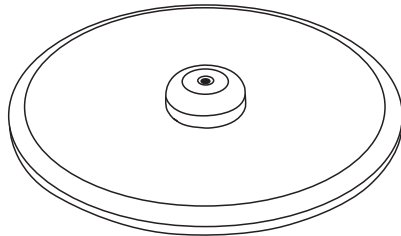

A



B

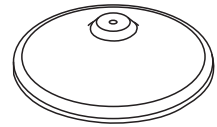

C

1



x2  
Pcs.

2

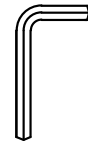

x1  
Pcs.



Read instructions, cover to cover-



Have 2 adults on hand for assembly-



Do not assemble on flooring or carpet-



Assemble on a clean, non-marring surface (packing foam)-

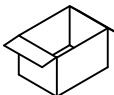

Save all packaging until finished-

## Assembly steps

### Overview

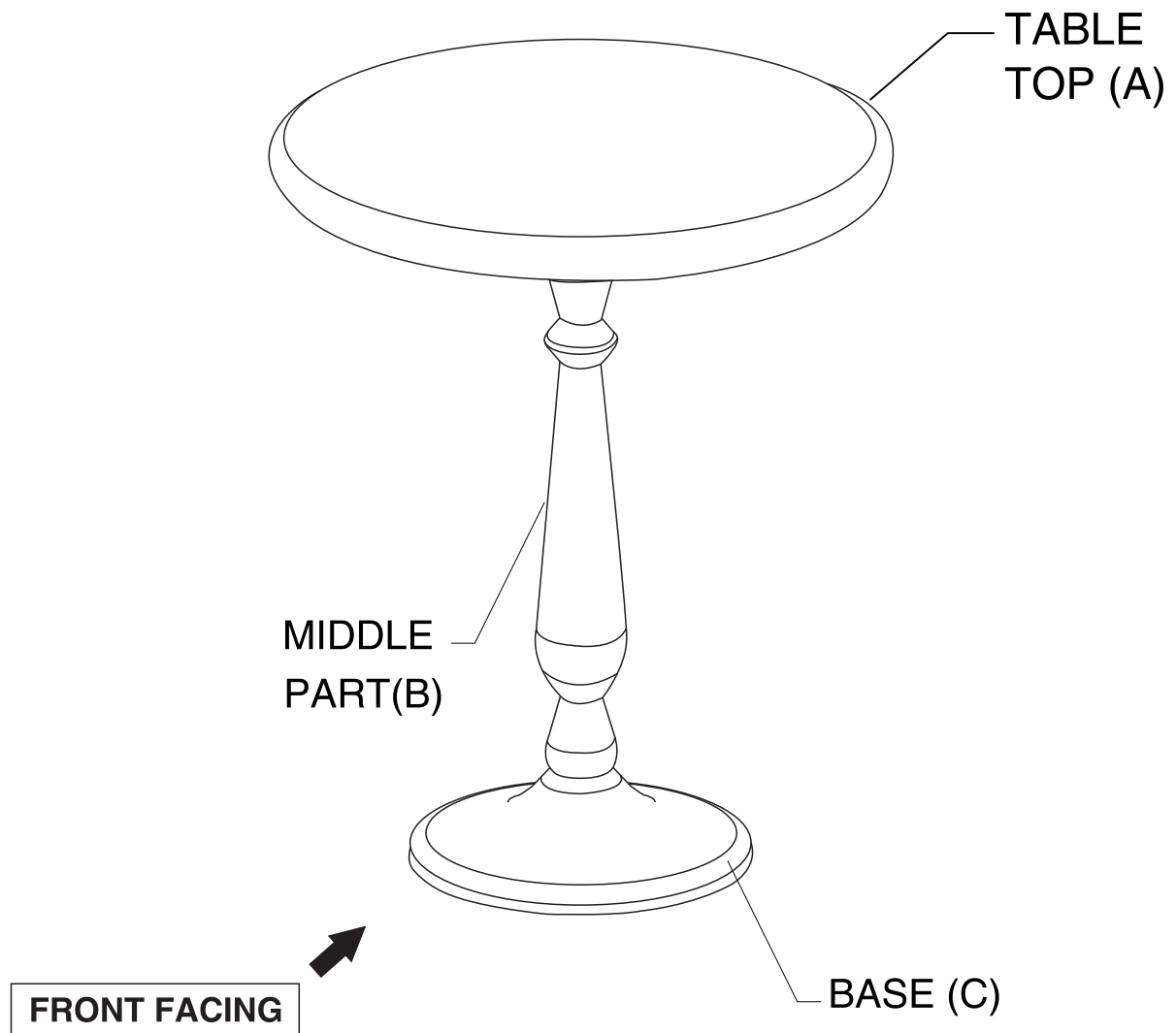

This End Table has multiple parts and may require up to some 30 minutes to assemble. To give you an overview of the End Table parts, the above picture is to help you put the various parts into perspective. Please read through the instructions below to familiarise yourself with the parts and steps before assembly.

## Step 1

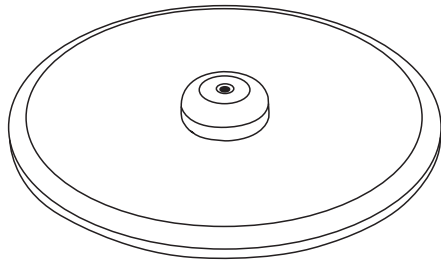

A



B

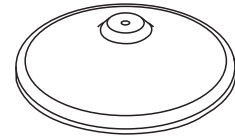

C

Unpack all parts and place them on a clean and non-marring floor to avoid scratches.

## Step 2

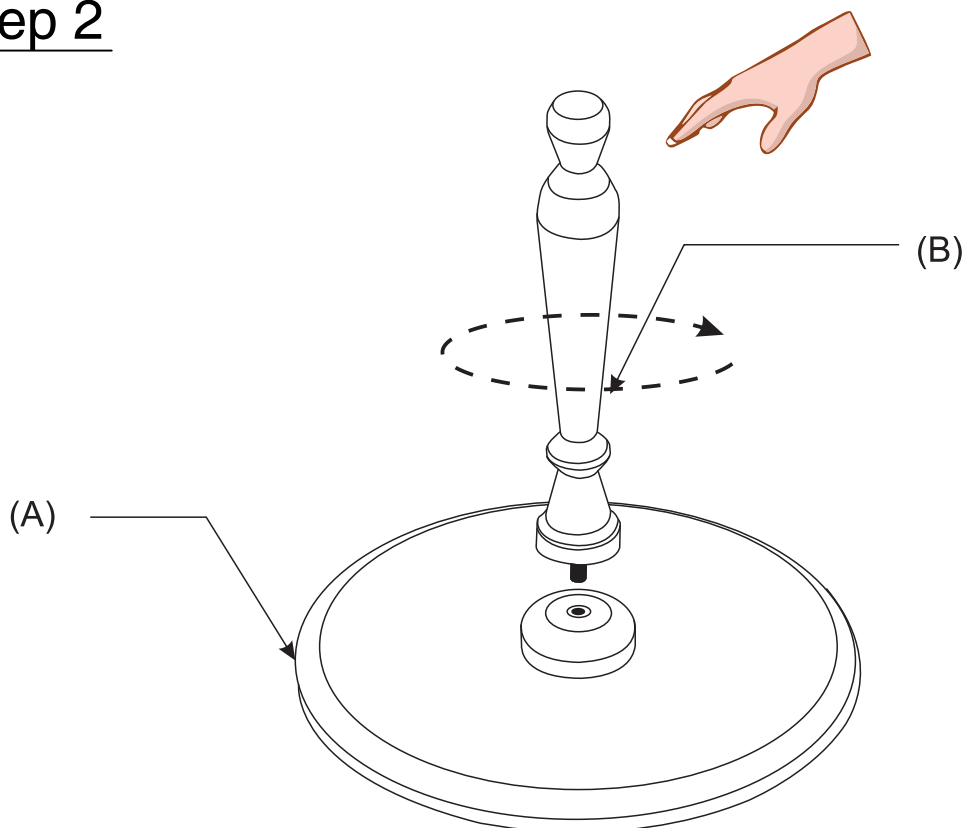

Align the Middle part (B) to the Table Top (A) and rotate towards the right side with the help of hand as shown in the picture above.

### Step 3

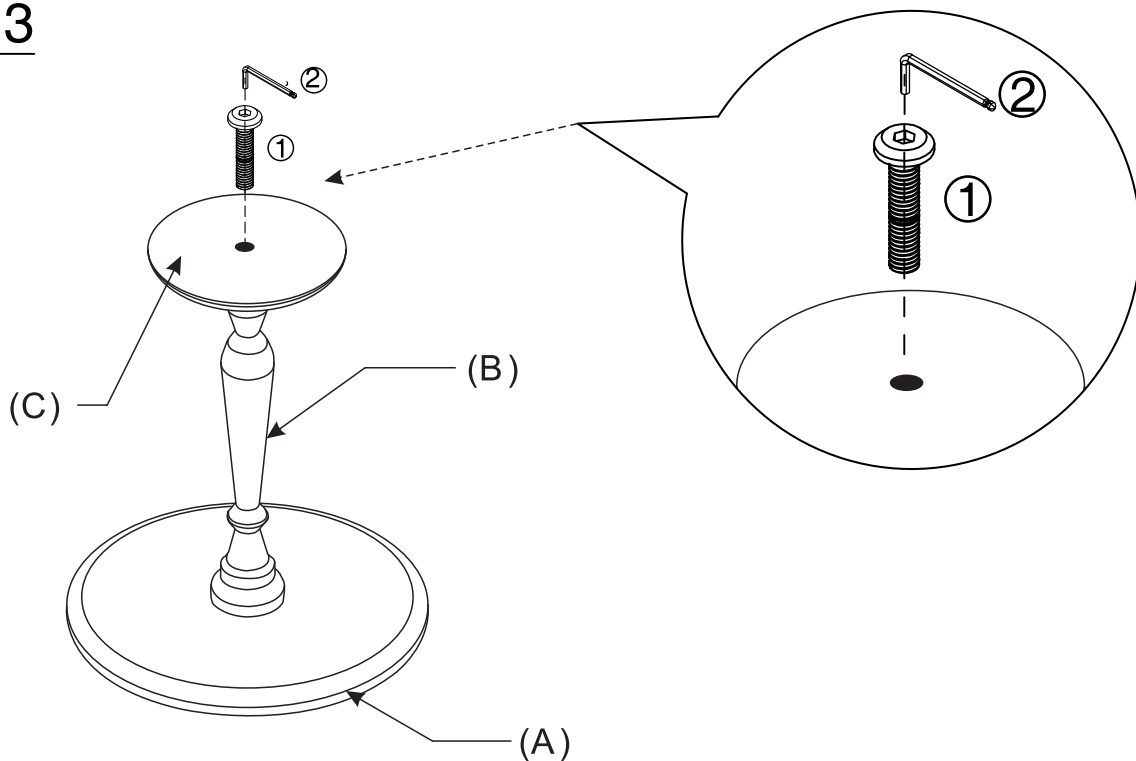





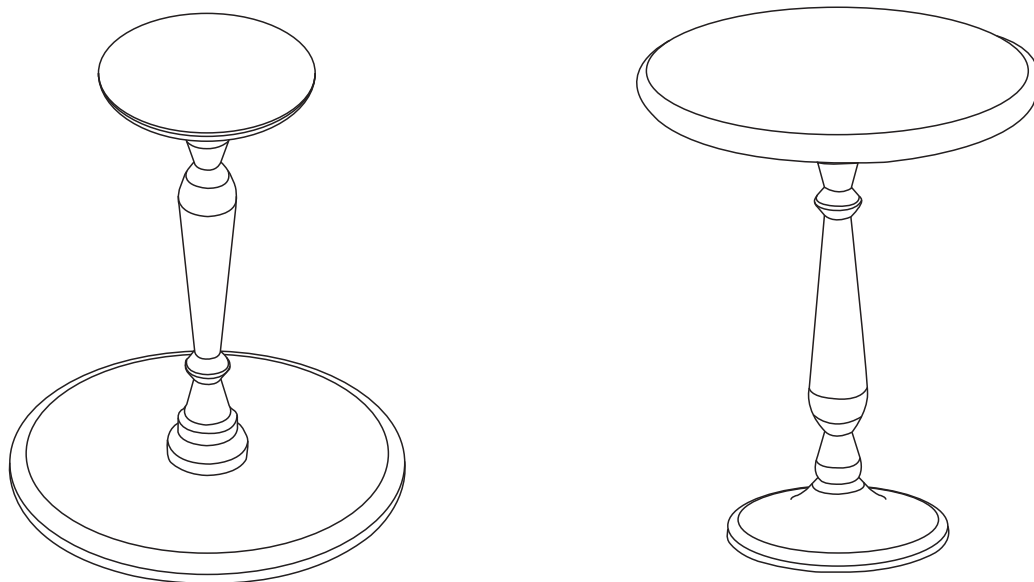





Align the Base (C) to the middle part (B) and attach it using the Bolt (①) with the help of Allen Wrench (②) and tighten the Bolt as shown in the picture above.

### Step 4



Turn the End Table right side up.  
Place the Table on a LEVEL SURFACE. Inspect it and make sure all parts are adequately connected.  
This End Table is ready to be use.  
**Caution 2: This End Table can only be used on a flat, level surface.**

## Care & Maintenance

- ✓  ● Furniture may scratch floors. We recommend using furniture pads to protect your floors.
- ⊘  ● Do not put hot items directly on furniture surface
- ⊘  ● Do not clean furniture with harsh cleansers or polish.
- ⊘  ● Do not place furniture under direct sunlight.
- ⊘  ● Do not place furniture near heating or cooling vents.
- ⊘  ● Do not write on furniture without a padded barrier to protect the surface
- ⊘  ● Do not place furniture outside. for indoor use only.
- ⊘  ● Not for commercial use. for residential use only.
- ⊘  ● Stains may be removed with mild soap solution and damp cloth.
- ⊘  ● Children should not climb or jump on the furniture.
- ✓  ● Dust and pick-up spills using a clean, non-colored, lint-free cloth.