

Assembly Instructions

Caution : You must read this before you proceed

Sparkle Table

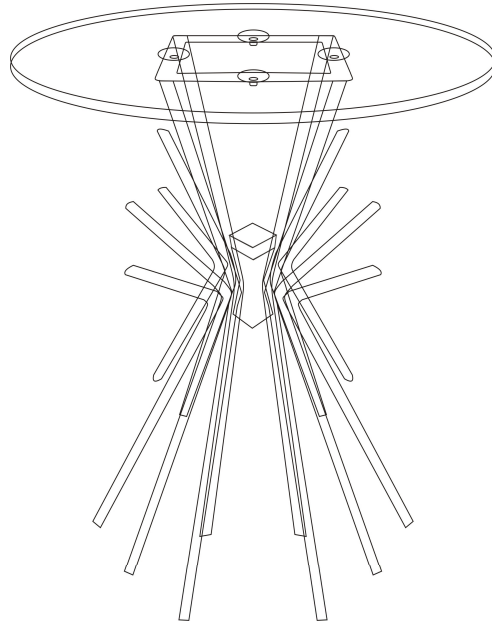

Parts List

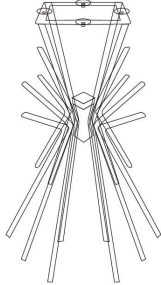
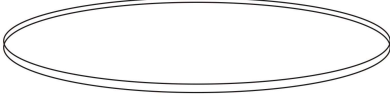
Label	Picture	Description	QTY
A		Stand	1
B		Glass Top	1

Hardware

Label	Picture	Description	QTY
①		Succers (Pre Attached)	4

Assembly Preparation

Before Beginning Assembly:

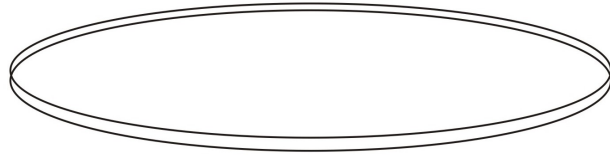
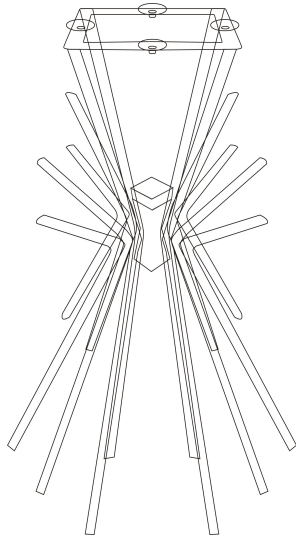

- Read instructions, cover to cover-



- Have 2 adults on hand for assembly-



- Do not assemble on flooring or carpet-



- Assemble on a clean non-marring surface (packing foam)-



- Save all packaging until finished-

Assembly Steps

Overview

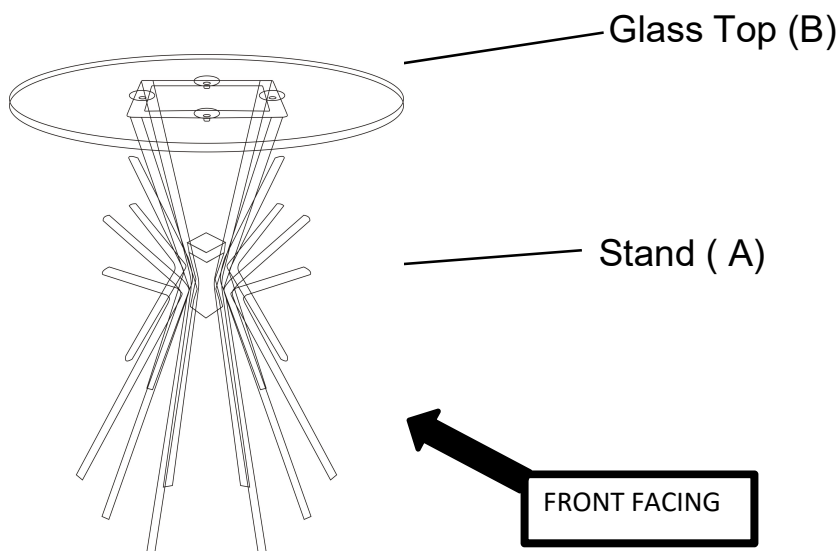

This SparkleTable has Two parts and may require up to some 30 minutes to assemble. To give you an overview of the Sparkle Table parts, the above picture is to help you put the various parts into perspective. Please read through the instructions below to familiarise yourself with the parts and steps before assembly.

Step 1

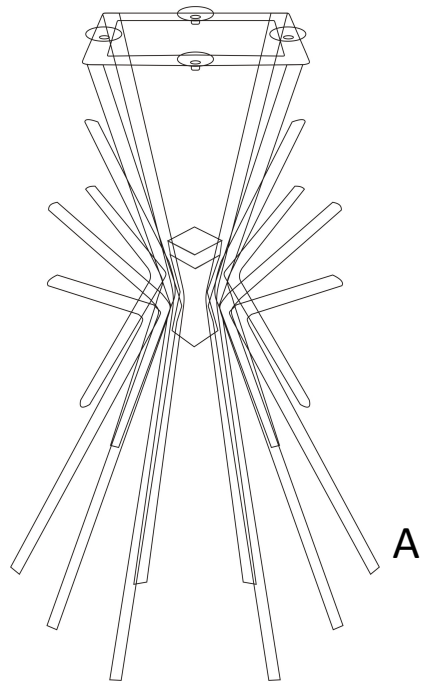

Put Stand (A) on the levelled floor like above.



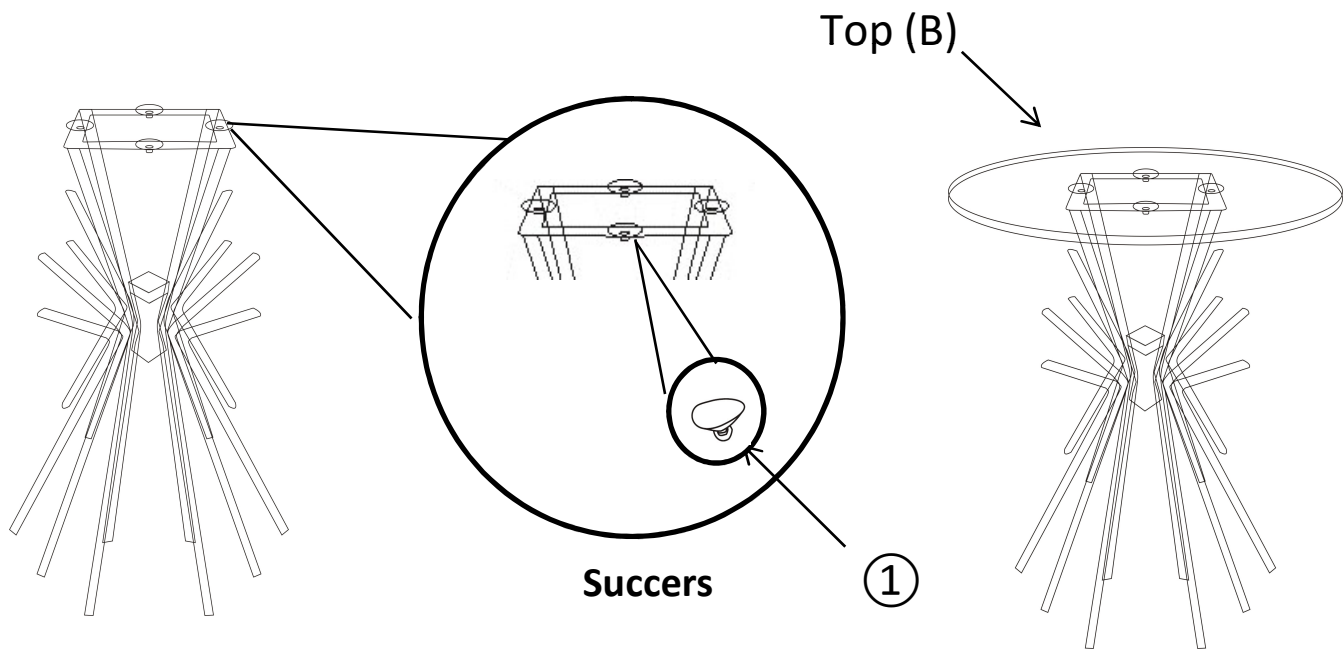

















Step 2



Place Glass top (B) on the Stand (A) where succers (①) are pre attached. This Sparkle table is now ready to use.

Caution: This Sparkle Table can only be used on flat, level surface.

Care & Maintenance

-   ● Do not put hot items directly on furniture surface.
 -   ● Do not clean furniture with harsh cleansers or polish.
 -   ● Do not place furniture under direct sunlight.
 -   ● Do not place furniture near heating or cooling vents.
 -   ● Do not write on furniture without a padded barrier to protect the surface.
 -   ● Do not place furniture outside. For indoor use only.
 -   ● Not for commercial use. For residential use only.
 -   ● Stains may be removed with mild soap solution and damp cloth.
 -   ● Children should not climb or jump on furniture.
-
-   ● Dust and pick-up spills using a clean, non-colored, lint-free cloth.