

# Assembly Instructions

**Caution : You must read this before you proceed**

## DINING TABLE

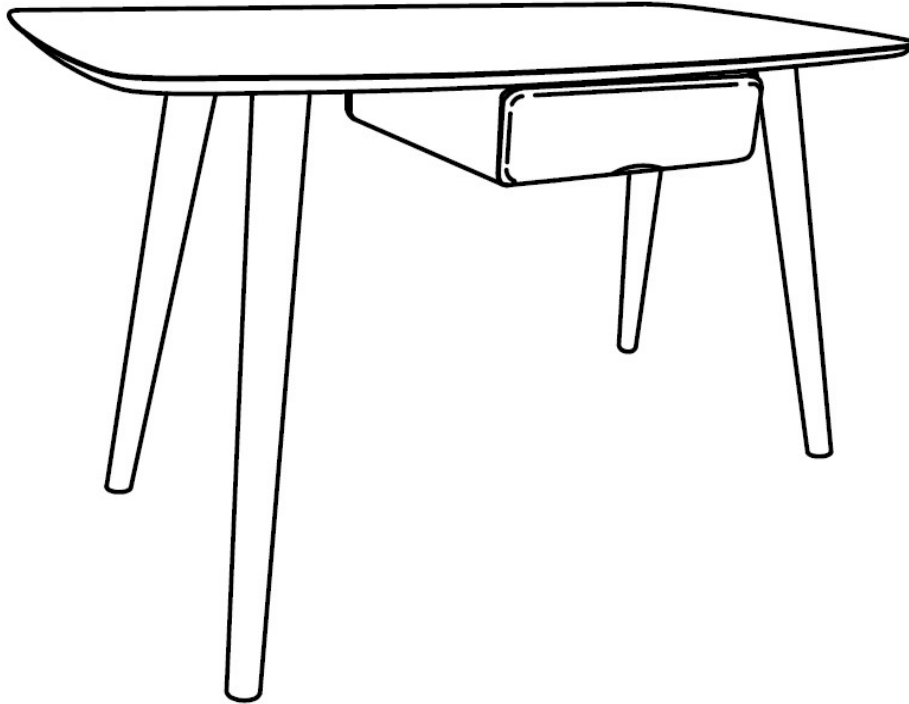

### Part List

Label	Picture	Description	QTY
A	A line drawing of the table top, showing its rectangular shape with rounded corners and a small rectangular cutout on the underside.	Table Top	1
B	A line drawing of a single table leg, which is a long, thin, tapered cylinder with a small hole at one end.	Table Leg	4

# Assembly Preparation

Before Beginning Assembly:

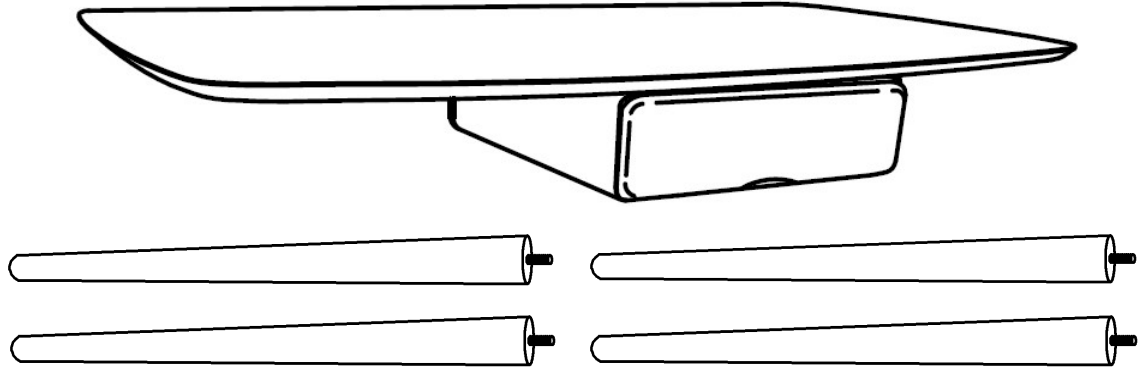

- Read instructions, cover to cover-



- Have 2 adults on hand for assembly-



- Do not assemble on flooring or carpet-



- Assemble on a clean non-marring surface (packing foam)-



- Save all packaging until finished-

# Assembly Steps

## Overview

Table Top  
(A)

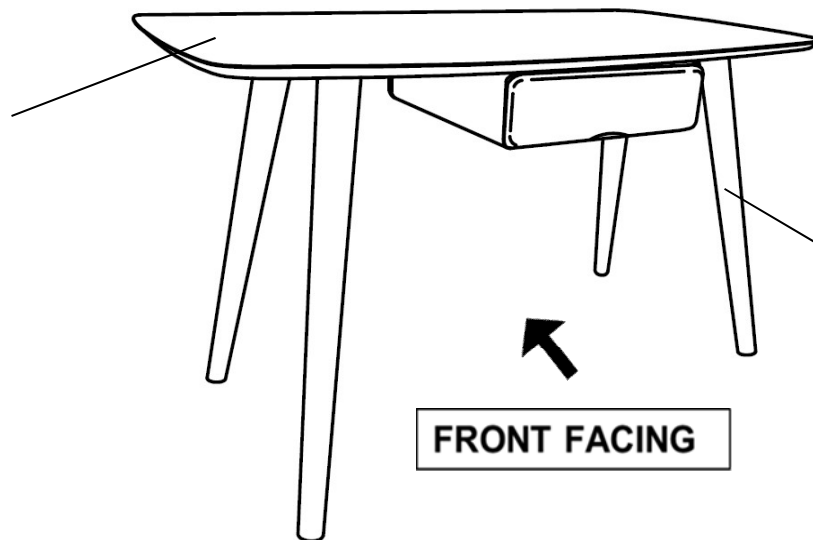
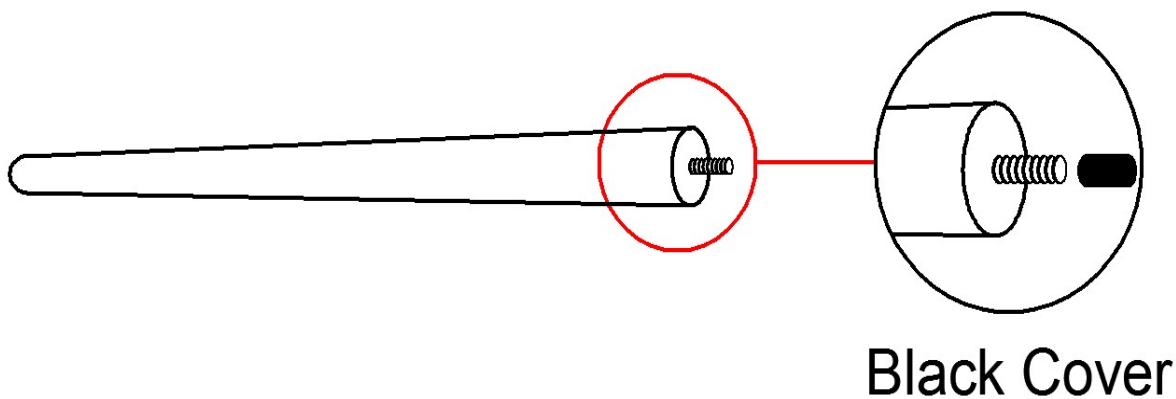

Table Leg  
(B)

FRONT FACING

This Study Table has multiple parts and may require up to some 30 minutes to assemble. To give you an overview of the Study Table parts, the above picture is to help you put the various parts into perspective. Please read through the instructions below to familiarise yourself with the parts and steps before assembly.

## Step 1



Open the carton and place all parts onto a clean, non-marring surface.  
Remove the Black Cover on the threaded stem of the Legs(B).

## Step 2

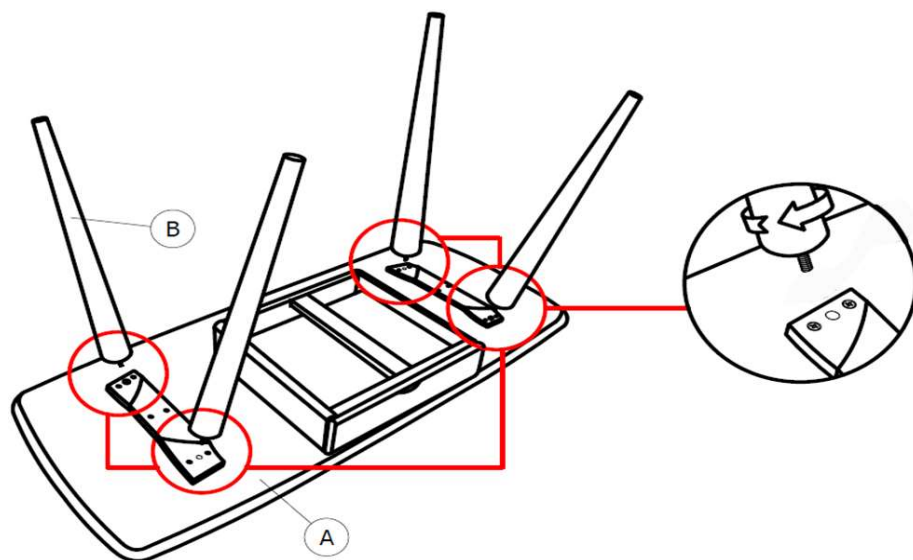

Place Table Top(A) facedown as pictured above.  
Install the Legs(B) into the bottom of the Table Top(A) by  
insert the threaded stem into the threaded mounting position at each Corner  
of the Bottom of the Table Top(A).  
Tighten by turning the Legs clockwise.

**Position Table right side up and test for stability on a Level Surface.**



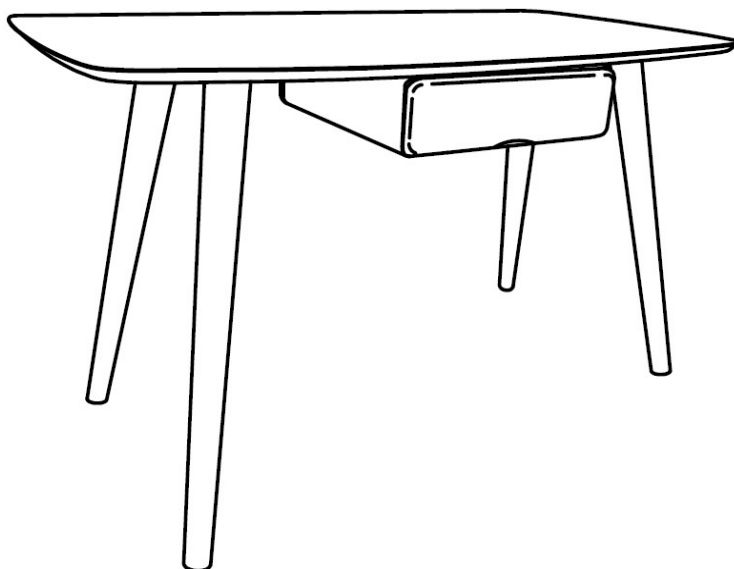

















### Step 3



With assistance from your adult partner, stand the Table up.  
Your Table is now ready for use.  
The Table can be only used on a flat, level surface.

## Care & Maintenance

### Care & Maintenance

-   ● Do not put hot items directly on furniture surface.
  -   ● Do not clean furniture with harsh cleansers or polish.
  -   ● Do not place furniture under direct sunlight.
  -   ● Do not place furniture near heating or cooling vents.
  -   ● Do not write on furniture without a padded barrier to protect the surface.
  -   ● Do not place furniture outside . For indoor use only .
  -   ● Not for commercial use. For residential use only .
  -   ● Stains may be removed with mild soap solution and damp cloth.
  -   ● Children should not climb or jump on the furniture.
- 
-   ● Dust and pick-up spills using a clean, non-colored, lint-free cloth .