

# Assembly Instructions

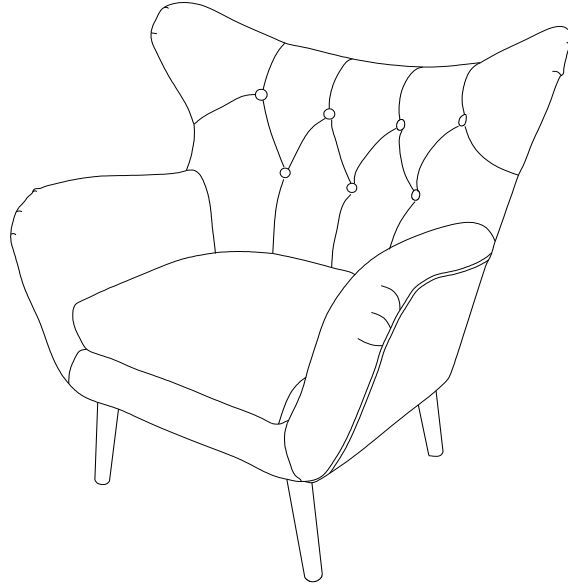

**Caution : You must read this before you proceed**

**Please look in seat for hardware packs and legs.**

## Club Chair



### Parts List

Label	Picture	Description	QTY
A		Chair	1
B		Front Leg	2
C		Back Leg	2

# Hardware

Label	Picture	Description	QTY
①		Bolt (M8*60MM)	9
②		Spring Washer	9
③		Washer	9
④		Allen Key	1

# Assembly Preparation

**Before Beginning Assembly:**



- Read instructions, cover to cover-



- Have 2 adults on hand for assembly-



- Do not assemble on flooring or carpet-



- Assemble on a clean non-marring surface (packing foam)-



- Save all packaging until finished-

# Assembly Steps

## Overview

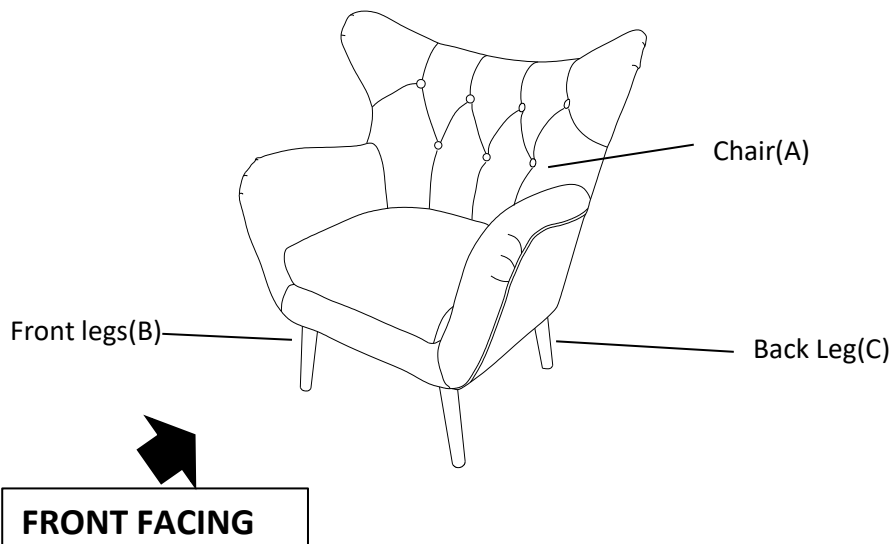

This Club Chair has multiple parts and may require up to some 30 minutes to assemble. To give you an overview of the Club Chair parts, the above picture is to help you put the various parts into perspective. Please read through the instructions below to familiarise yourself with the parts and steps before assembly.

### Step 1

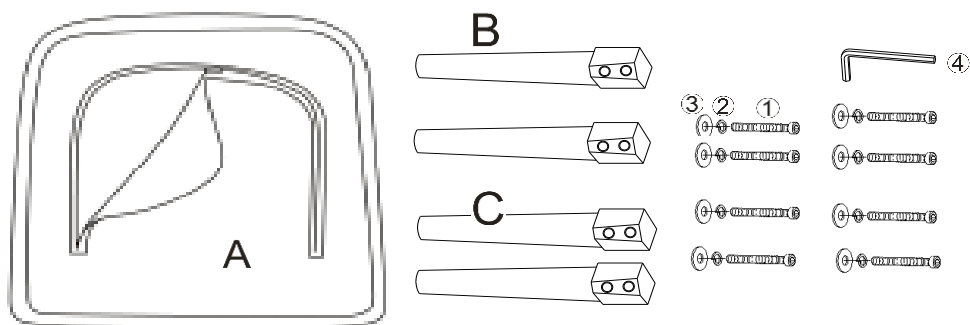

Position Chair(A) on its back as shown.  
 (DO NOT place on surface that can scratch or damage upholstery.)  
 Carefully peel away the dust cover from the edge.  
 Take the Legs and Hardware bag out of the Chair bottom.

### Step 2

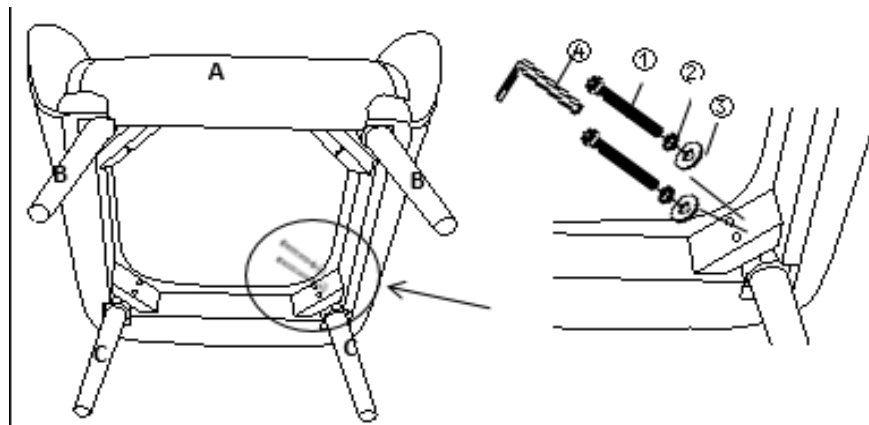

Insert the Front Leg(B) into the mounting position of Chair (A) .  
 Attach the Back Leg(C) using Bolts(1) , Spring Washers(2) and Washers(3)with Allen Key(4).  
 Repeat the same process to install the remaining three Legs.  
**At this stage, Loosely tighten these bolts.**

### Step 3

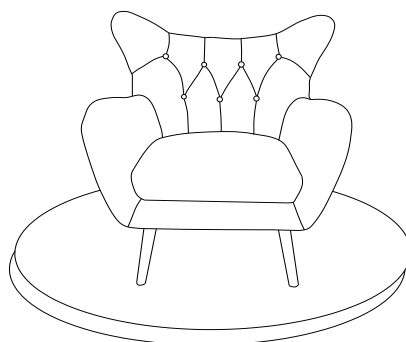

Place the chair on a **LEVEL SURFACE** to see if it wobbles.  
If it wobbles, press firmly down on both armrests at the same time. This will help to ensure all Bolts and gaps reach full alignment status.  
If no wobbles found, proceed to tighten all the bolts. **DO NOT** fully tighten a **BOLT** in one go and then move on to the next. Rather, In a sequential manner, gradually tighten each Bolt until all bolts are evenly secured.  
This methodology will ensure maximum evenness once all Bolts are fully tightened.

**Step 4**



Turn over the product upsidedown onto a flat ,no-marring surface(as shown in picture) ,Smooth down with your hand on the Magic Tape on all 4 sides at the edge of the seat box.

**Step 5**

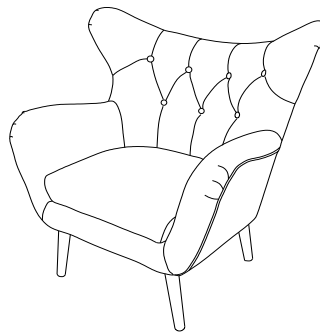

Place the Club Chair right side up, Make sure all parts are connected and securely locked into position.  
Your Club Chair is ready for use.  
**This Club Chair can only be used on a flat, level surface.**

# Care & Maintenance



● Furniture may scratch floors. We recommend using furniture pads to protect your floors.



● Do not put hot items directly on furniture surface.



● Do not clean furniture with harsh cleansers or polish.



● Do not place furniture under direct sunlight.



● Do not place furniture near heating or cooling vents.



● Do not write on furniture without a padded barrier to protect the surface.



● Do not place furniture outside . For indoor use only.



● Not for commercial use. For residential use only.



● Stains may be removed with mild soap solution and damp cloth.



● Children should not climb or jump on the furniture.



● Dust and pick-up spills using a clean, non-colored, lint-free cloth.