

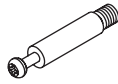

A x20
M15*12
+1(spare)



B x20
M6*40
+1(spare)



C x02
M6*15



D x08
M6*30
+1(spare)



E x04
M6*40
+1(spare)

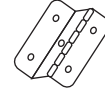

F x04



G x28
M3*12

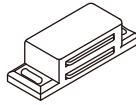

H x02

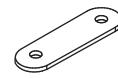

I x02



J x05



K x01

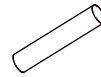

L x08

E x 2

K x 1

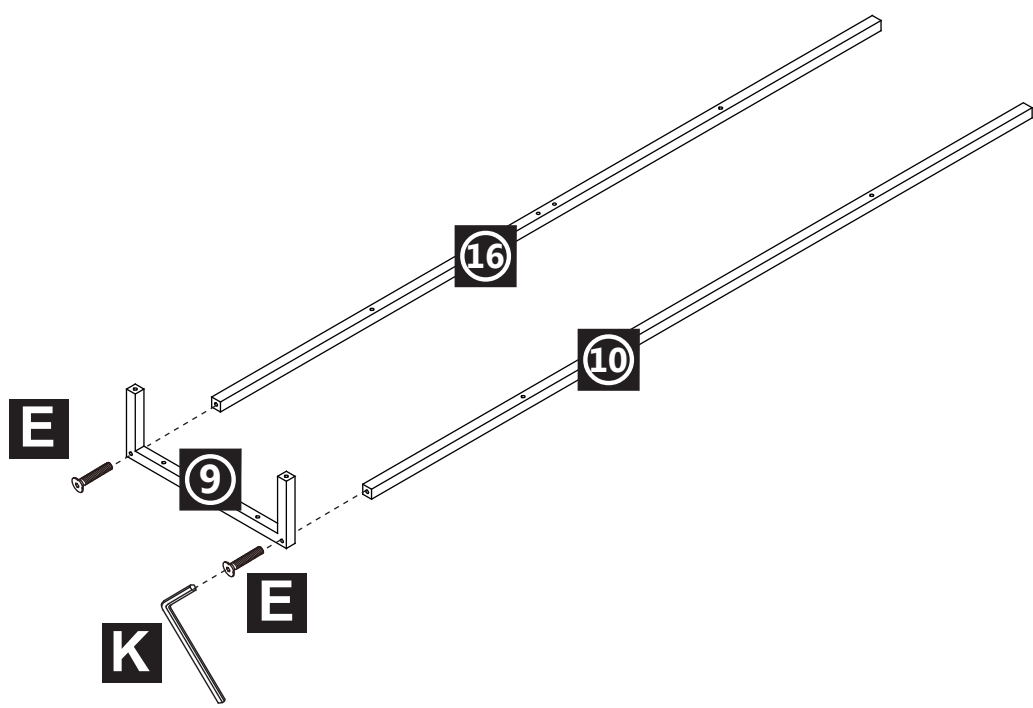

E x 2

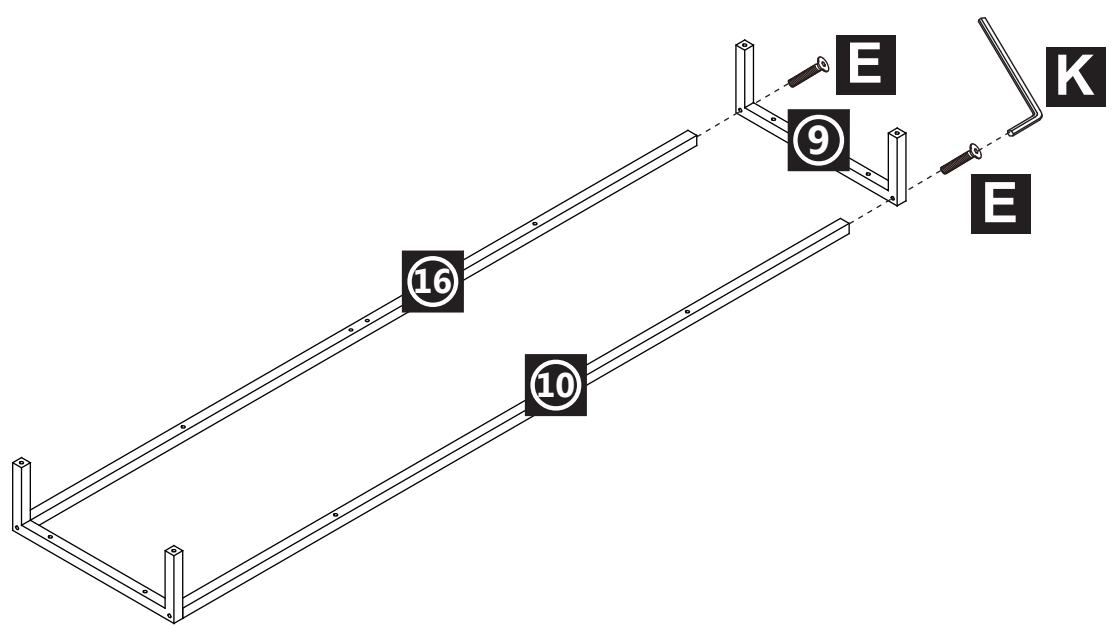

D x 8

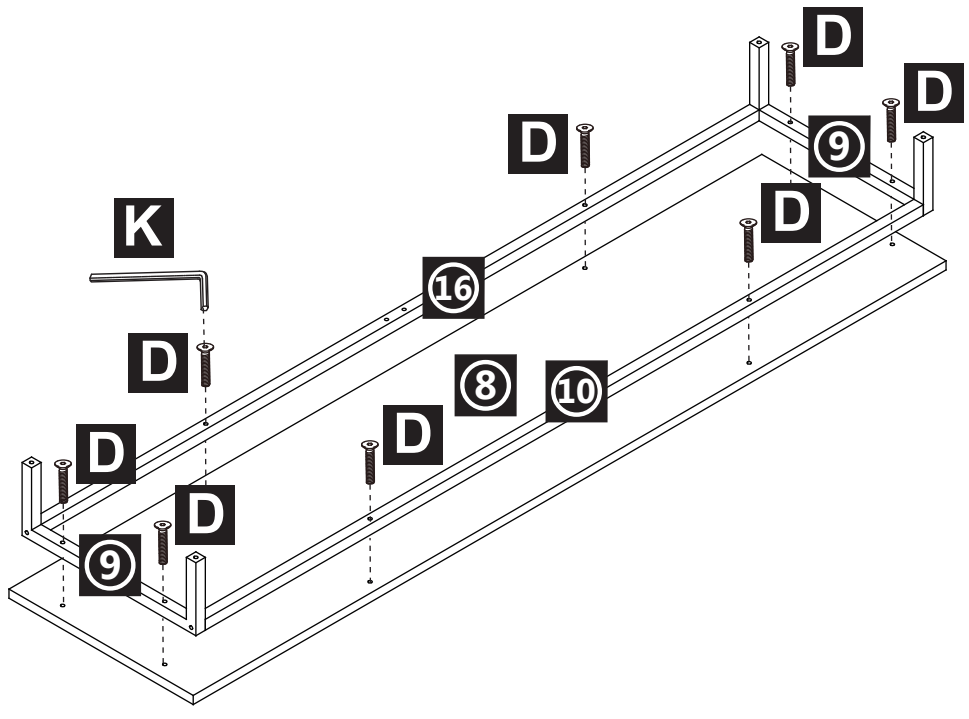

C x 2

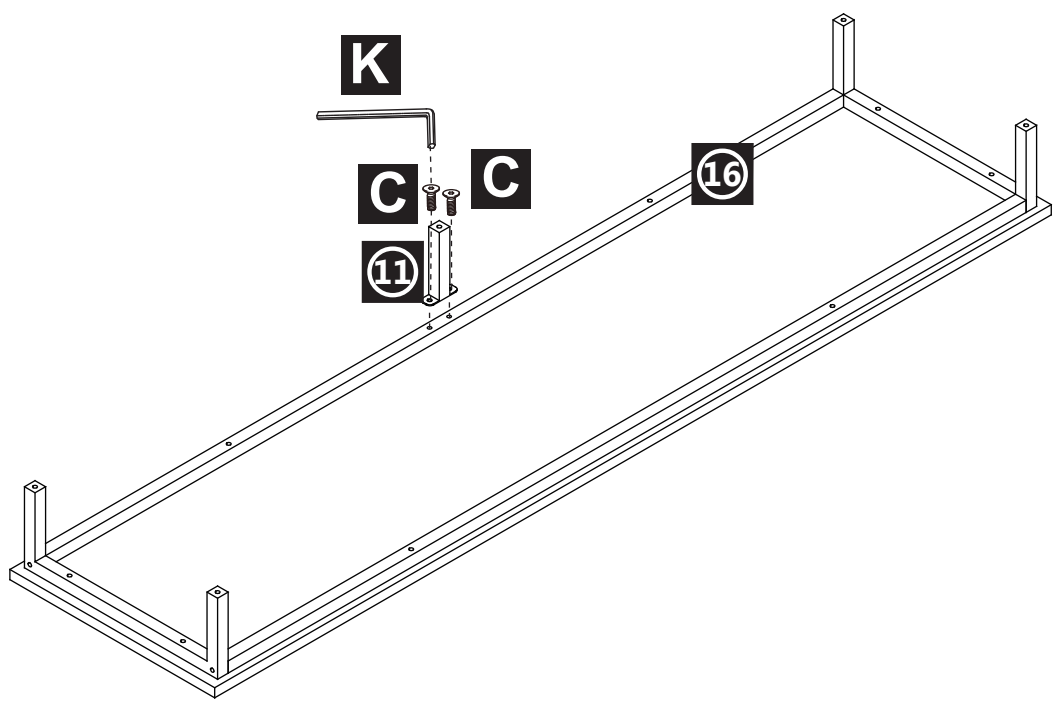

J x 5

05

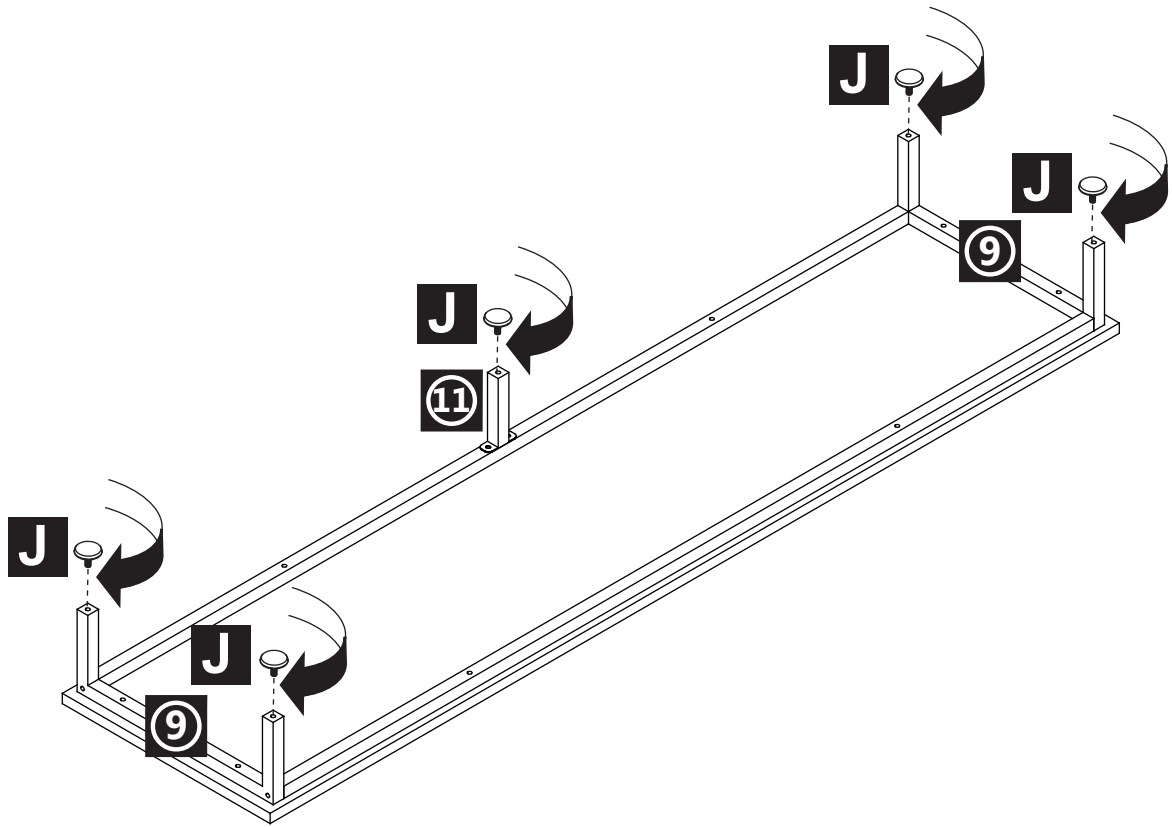

B x 8

06

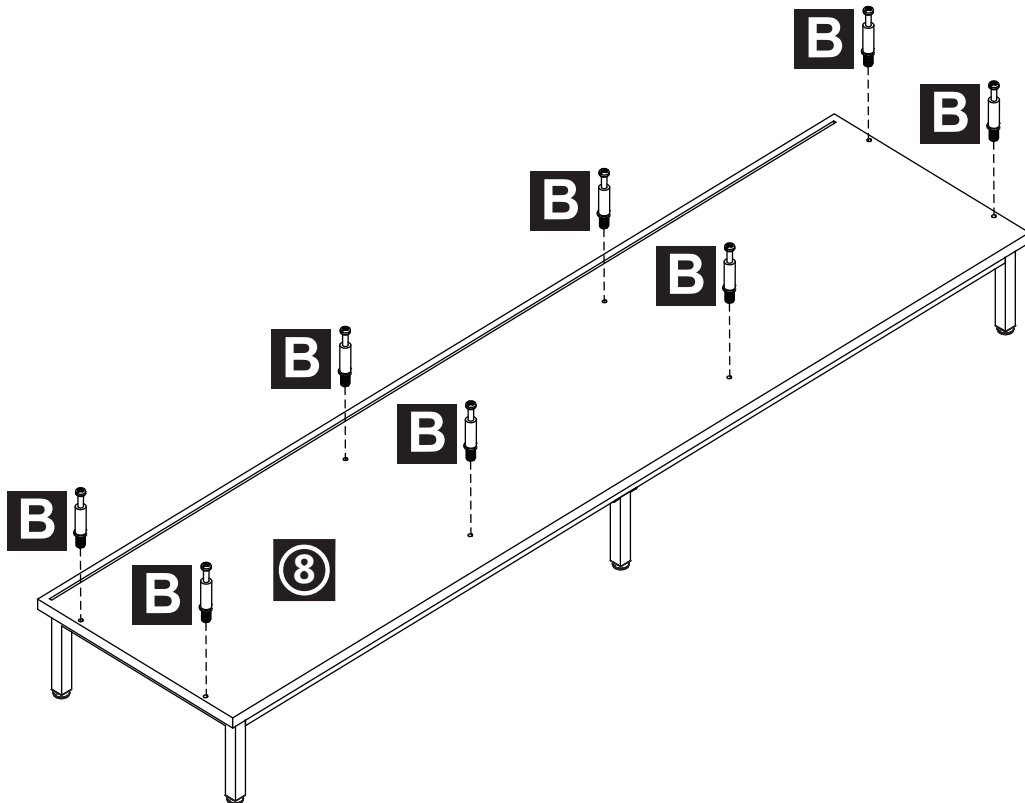

B x 4

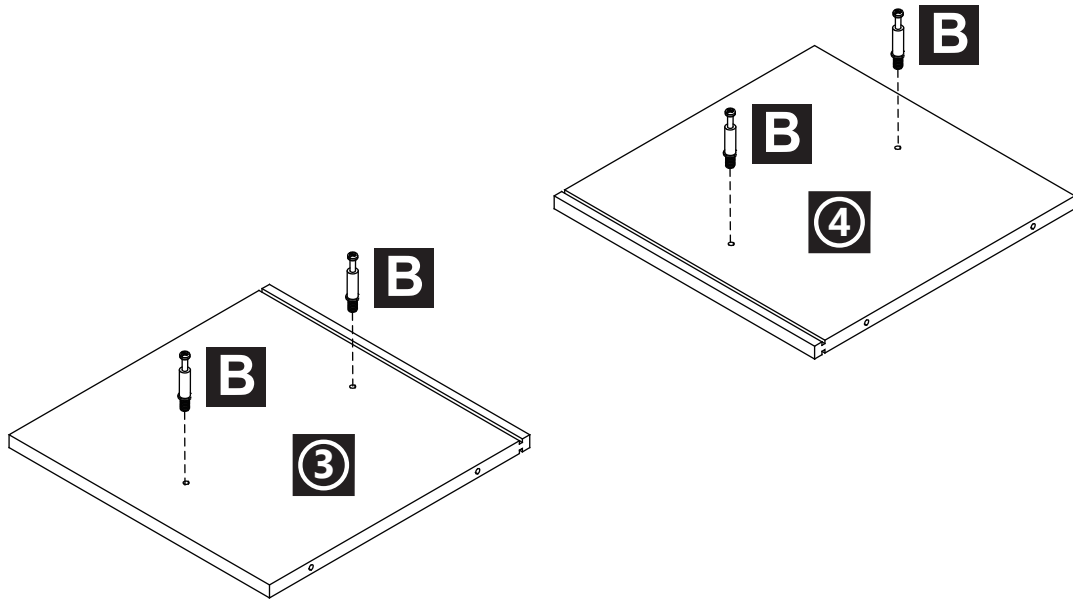

A x 4

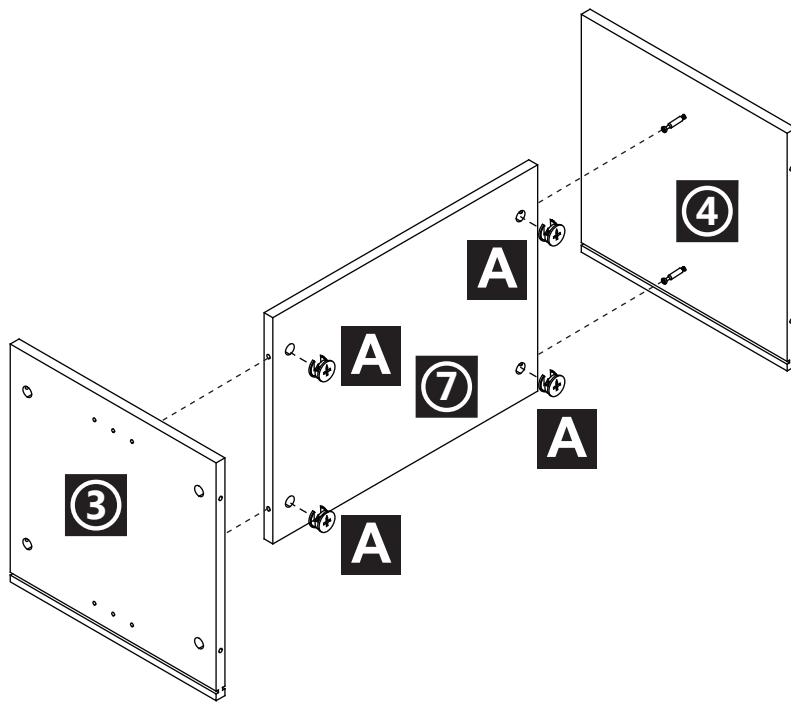

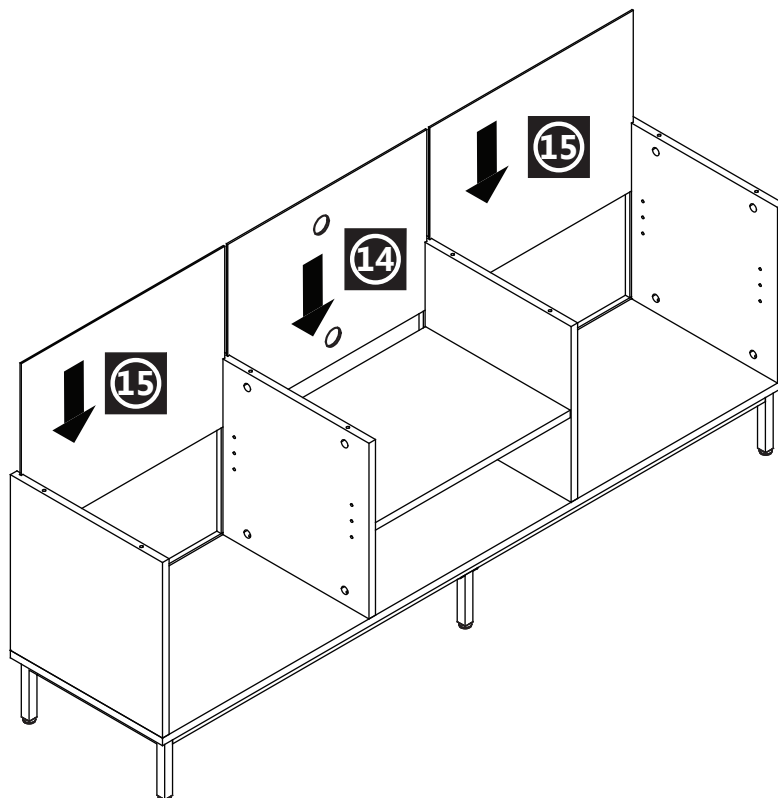
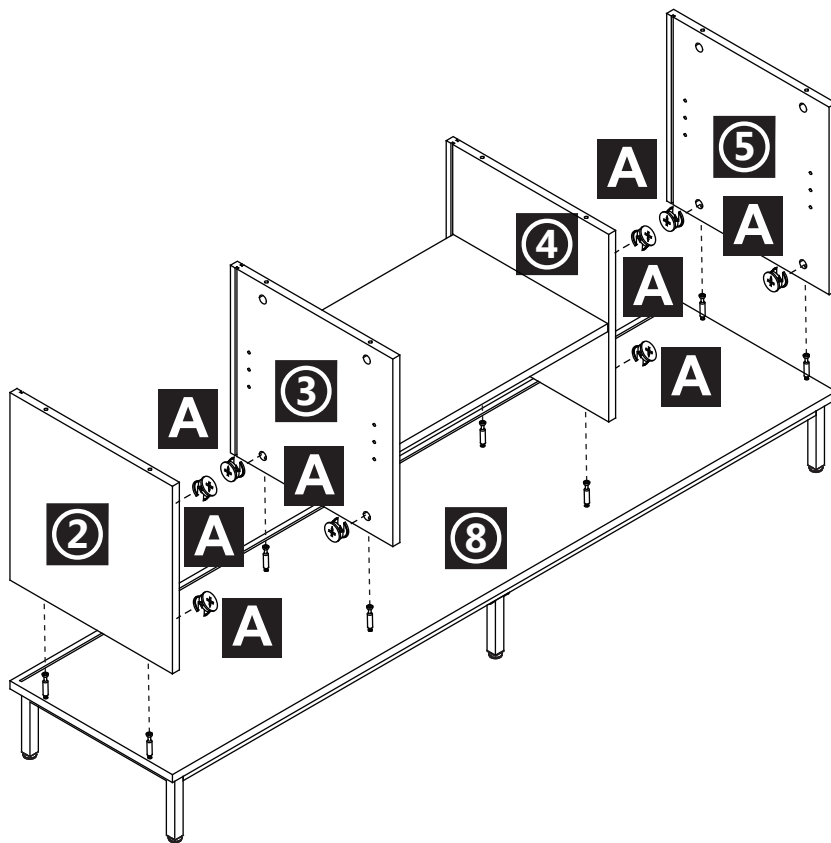

B x 8

G x 4

H x 2

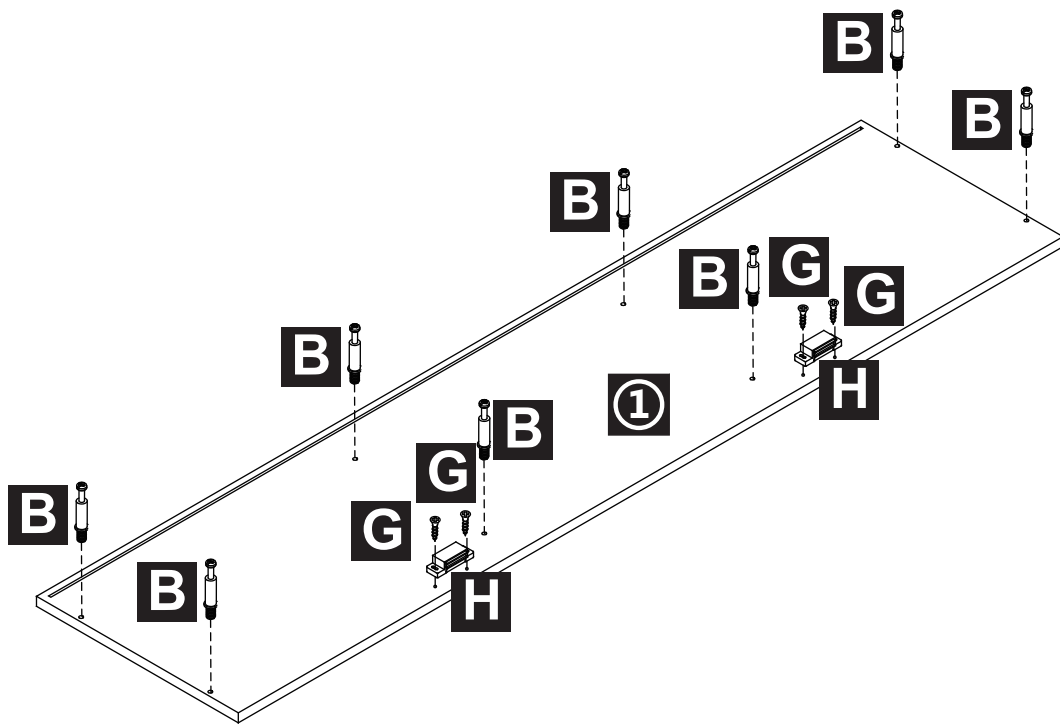

A x 8

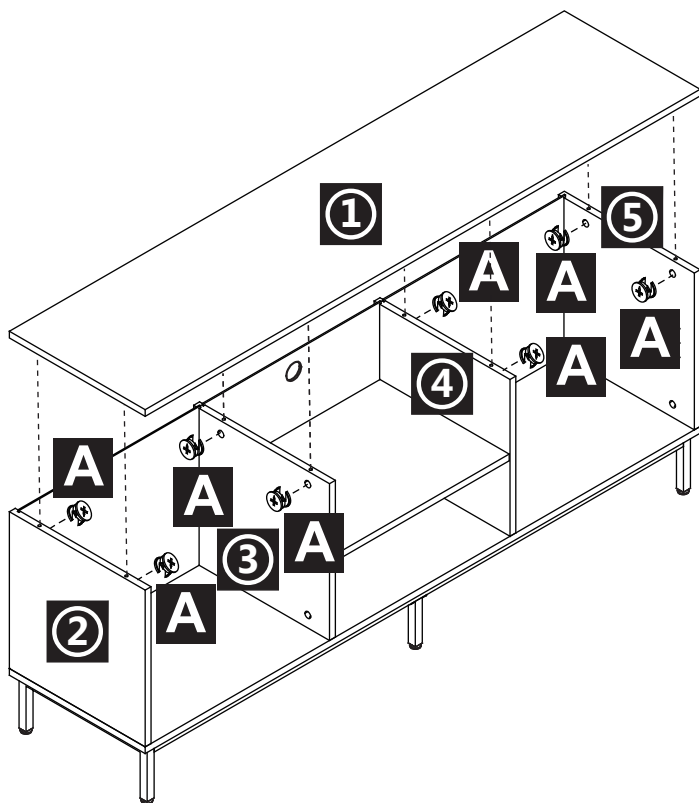

L x 8

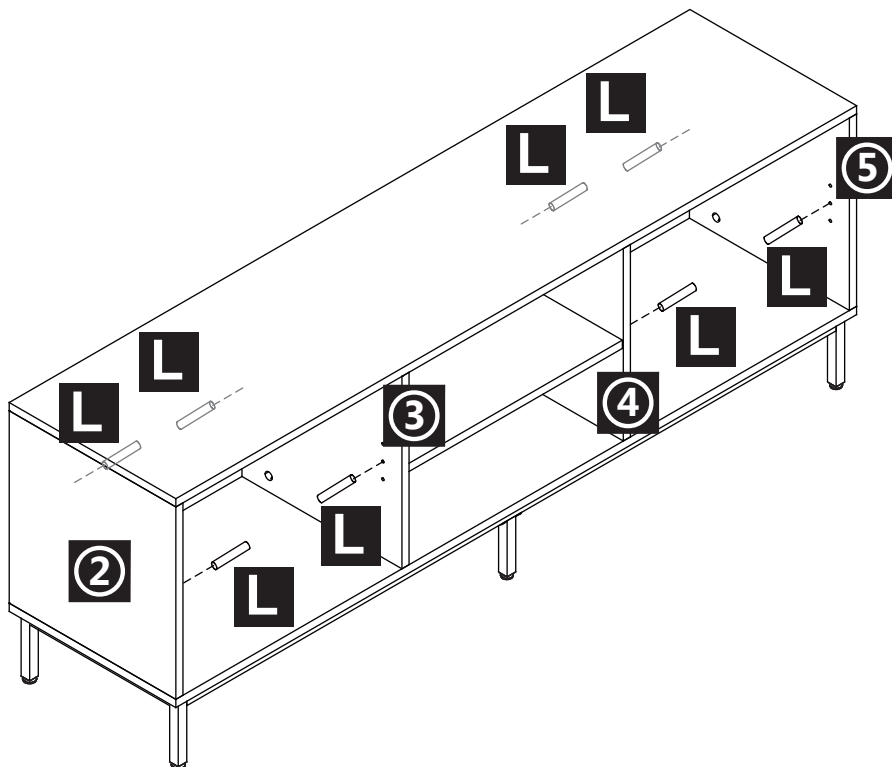

F x 4

G x 16

I x 2

