

Part list BOX 1:

M

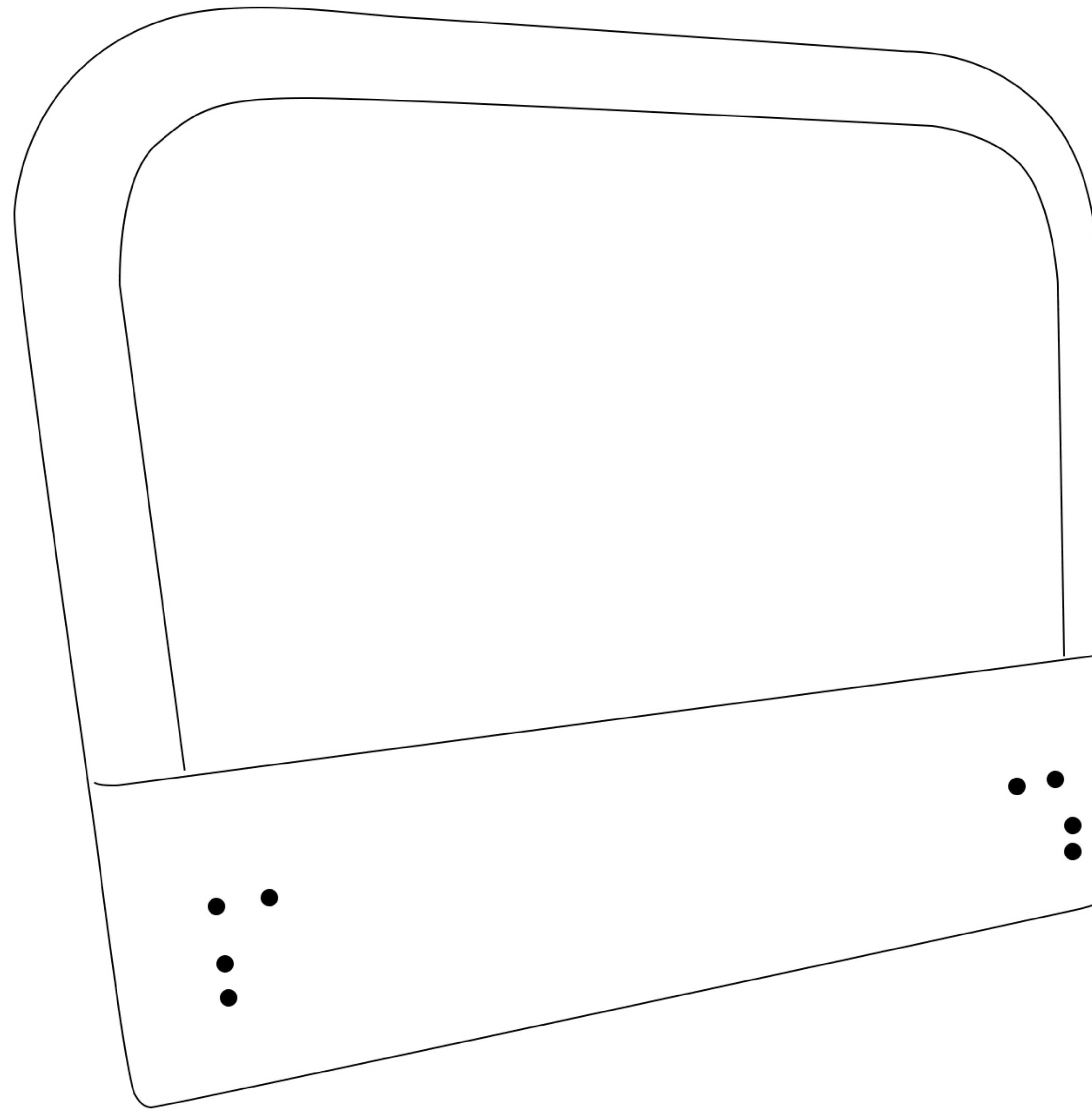

BEDHEA - (1 pcs)

G

PART LIST BC X 2:

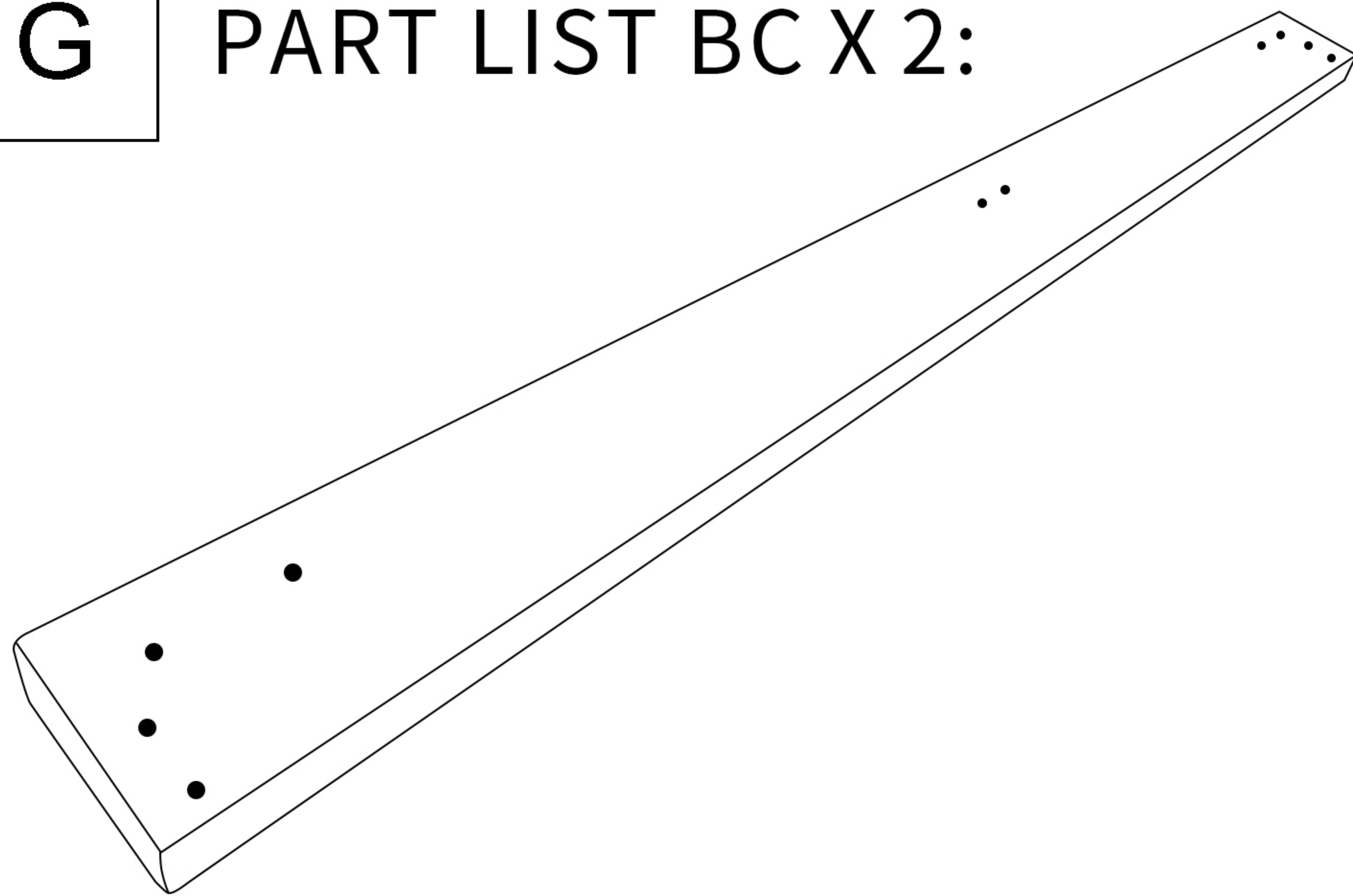

BEDSIDE - (2 pcs)

H

PART LIST BC X 2:

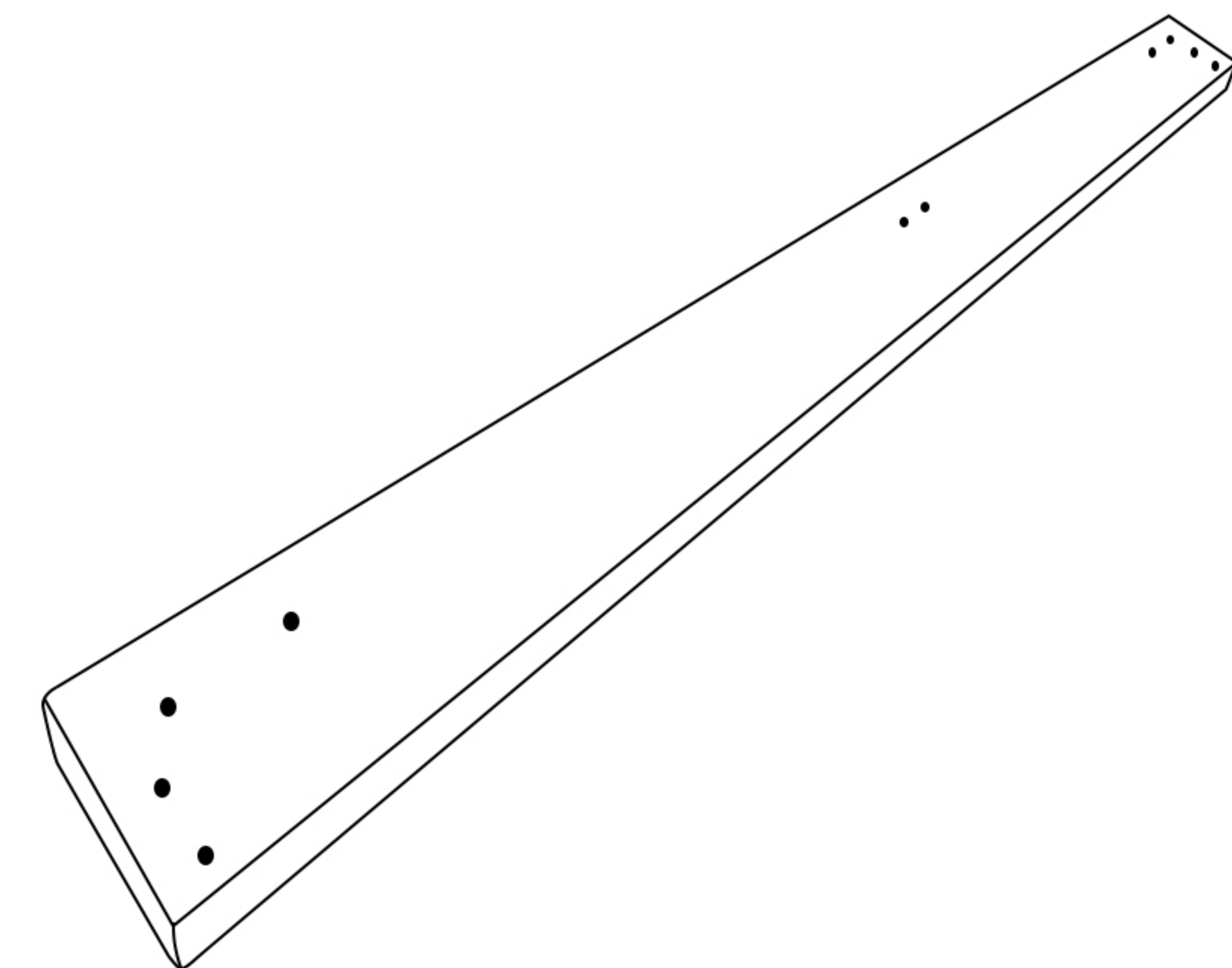

BED TAIL - (1 pcs)







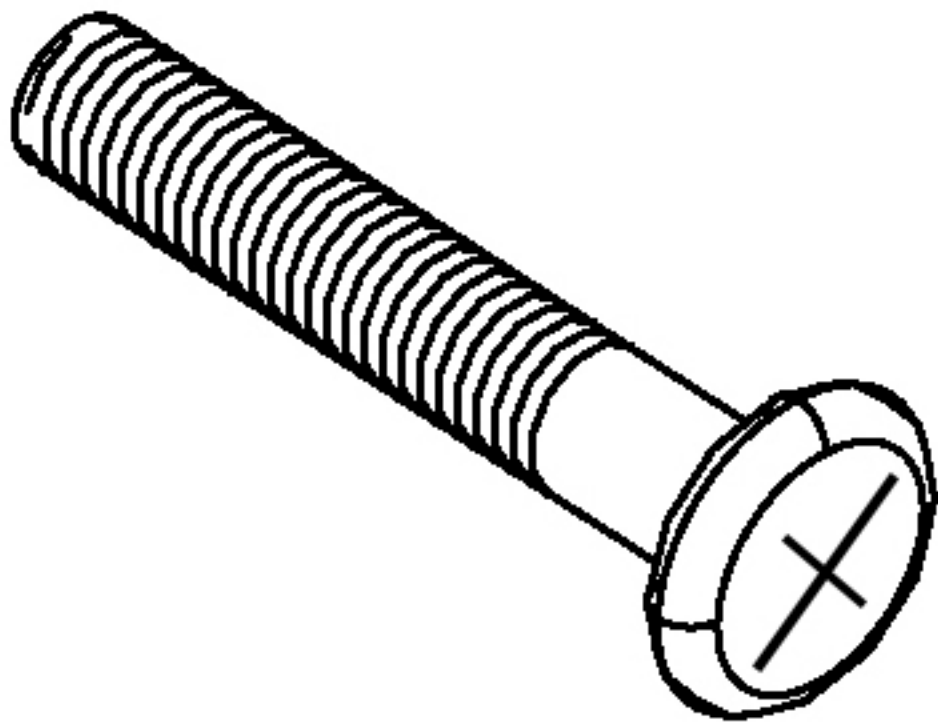
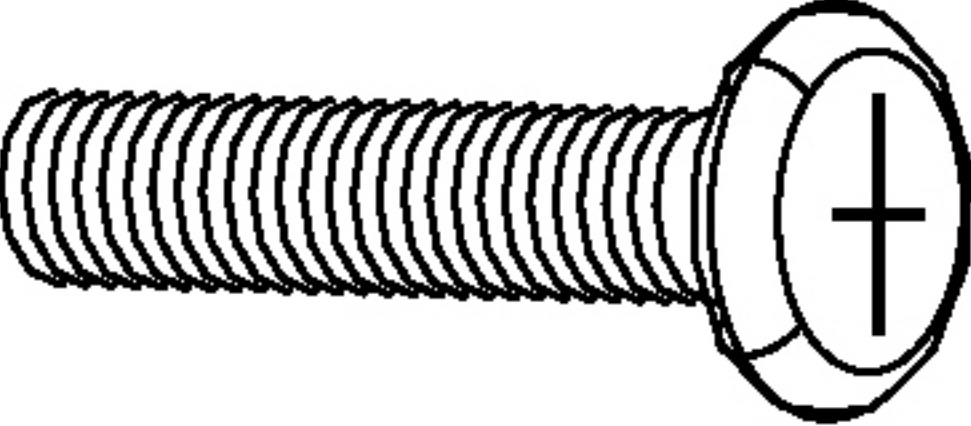
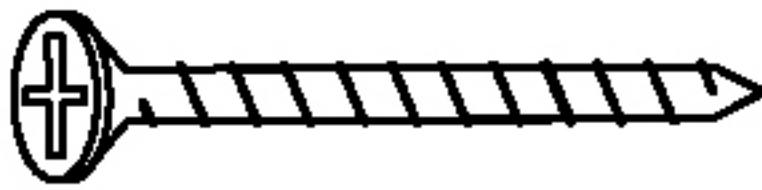
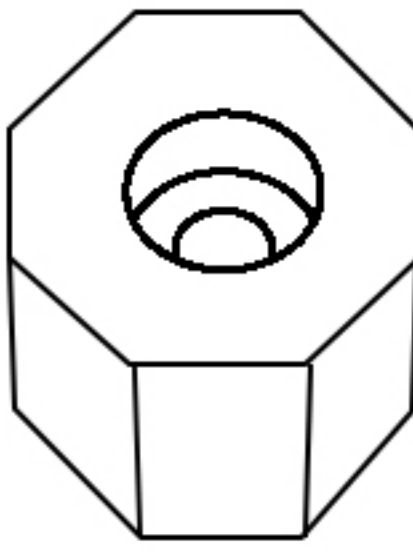

P

PART LIST BC X 3:



BED RACK FRAMEWORKDE - (1 pcs)

Hardware list

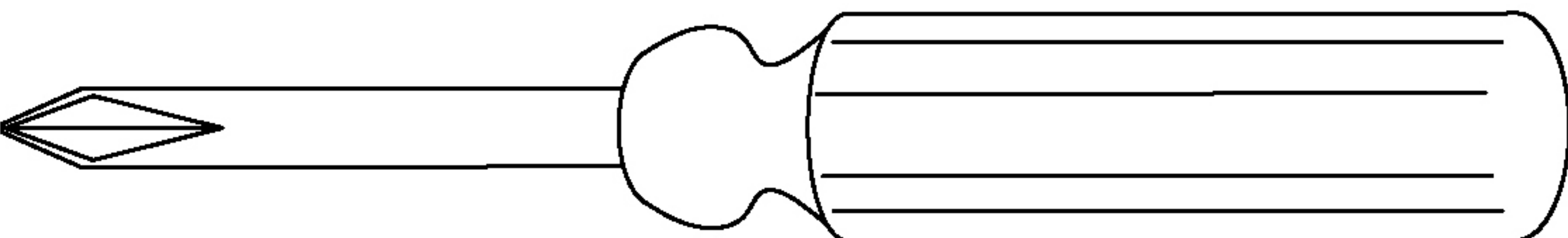
<p>1</p>  <p>1/4" x 50 mm Hex head bolts - 6 pcs</p>	<p>2</p>  <p>1/4" x 25 mm Hex head bolts - 40 pcs</p>	<p>3</p>  <p>m4 x 25 Wood screws - 12 pcs</p>	<p>4</p>  <p>connecting bar - 4 pcs</p>
<p>5</p>  <p>Ø25X3mm Mute pad-10 pcs</p>	<p>6</p>  <p>41X99mm CORNER BRACE-4 pcs</p>	<p>7</p>  <p>52X75mm CORNER BRACE-4 pcs</p>	<p>8</p>  <p>40X175mm CORNER BRACE-4 pcs</p>
<p>9</p>  <p>131X111mm BED FOOT-4 pcs</p>	<p>10</p>  <p>111X197-330mm ADJUSTER FOOT-2 pcs</p>	<p>11</p>  <p>45X197-330mm ADJUSTER FOOT-2 pcs</p>	<p>12</p>
<p>13</p>	<p>14</p>	<p>15</p>	<p>16</p>
<p>17</p>  <p>Assemble tools required (Not included)</p>			

PS:BEDHEAD AGAINST WALL

Step 1

1. AS SHOWN IN THE FIGURE, PLACE THE BED HEAD, BED FAIRY, BED TAIL, AND CORRESPONDING HARDWARE ACCESSORIES PROPERLY

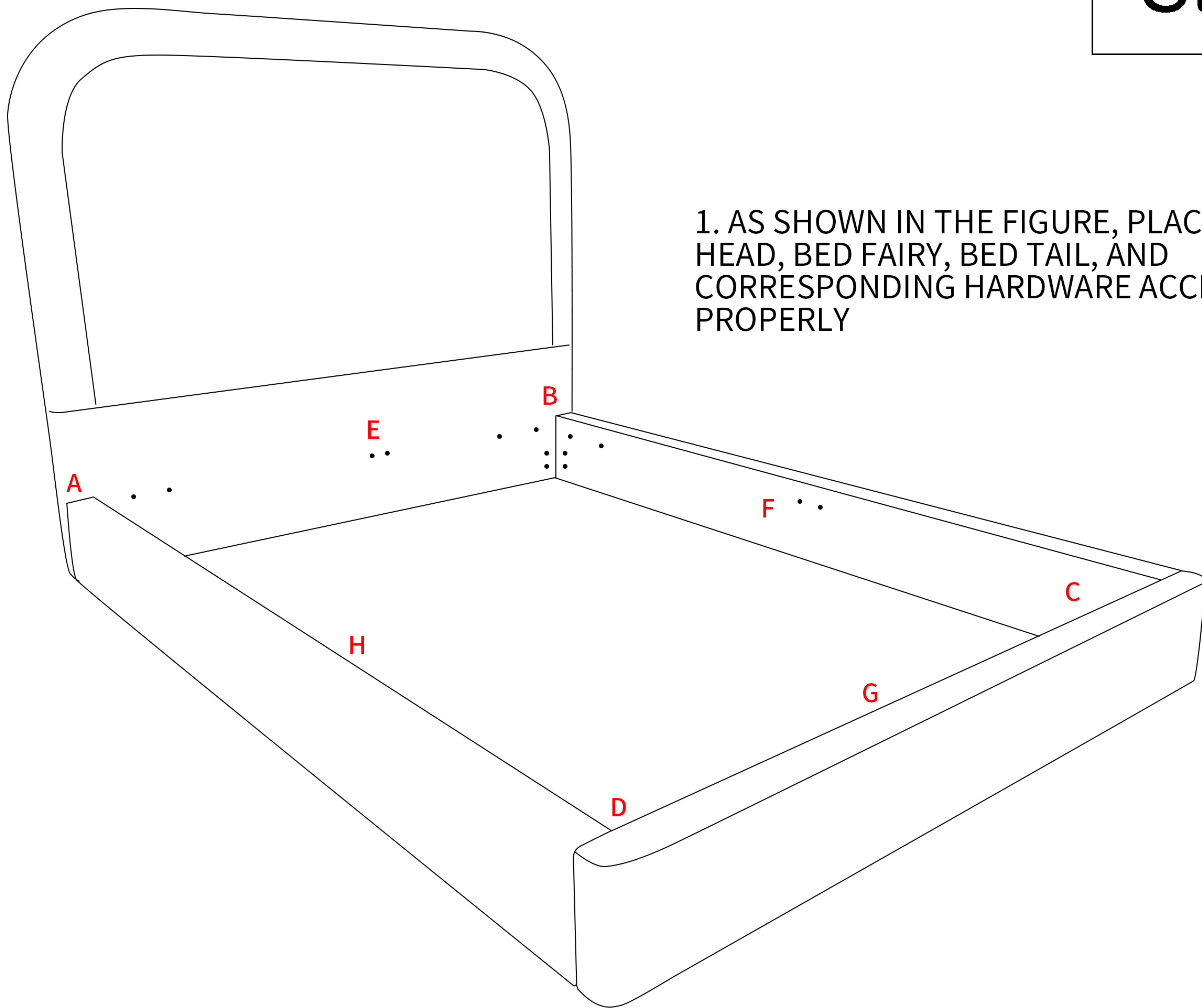

Step 2

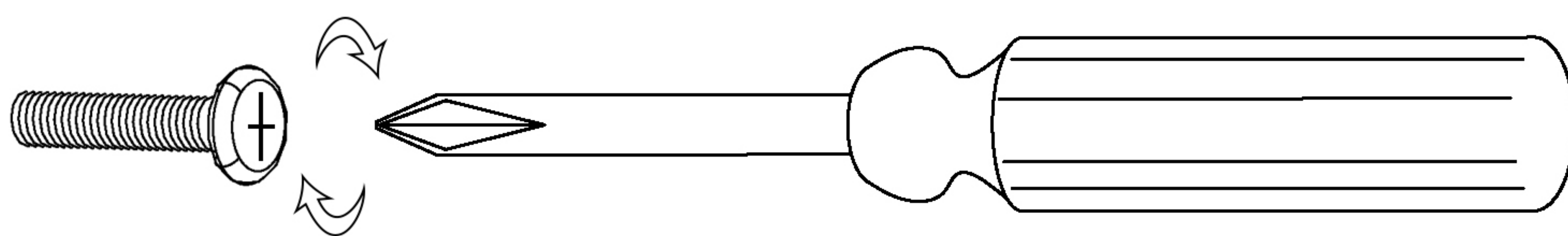

2

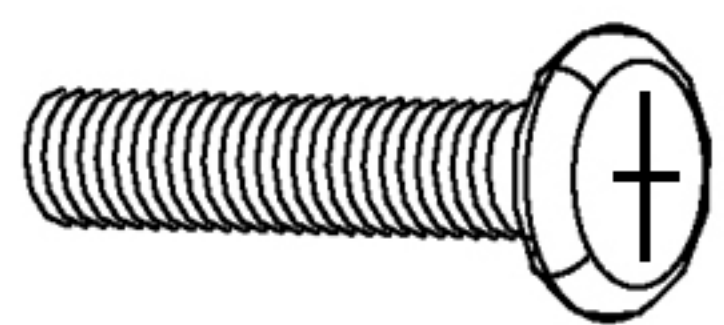

1/4" x 25 mm
Hex head bolts - 16 pcs

7



52X75mm
CORNER BRACE-2 pcs

8

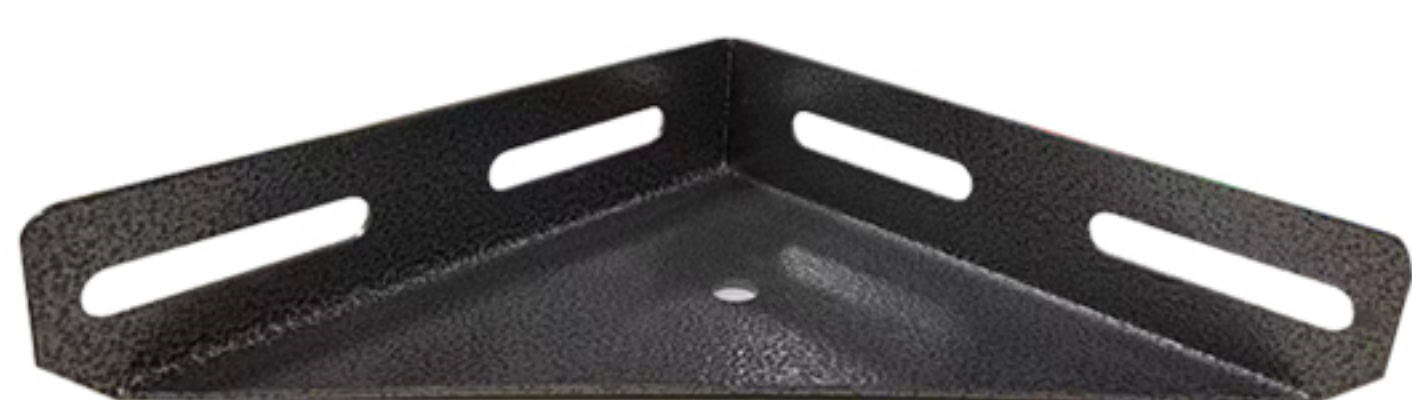

40X175mm
CORNER BRACE-2 pcs

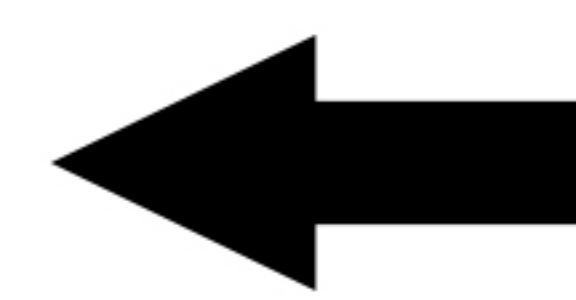
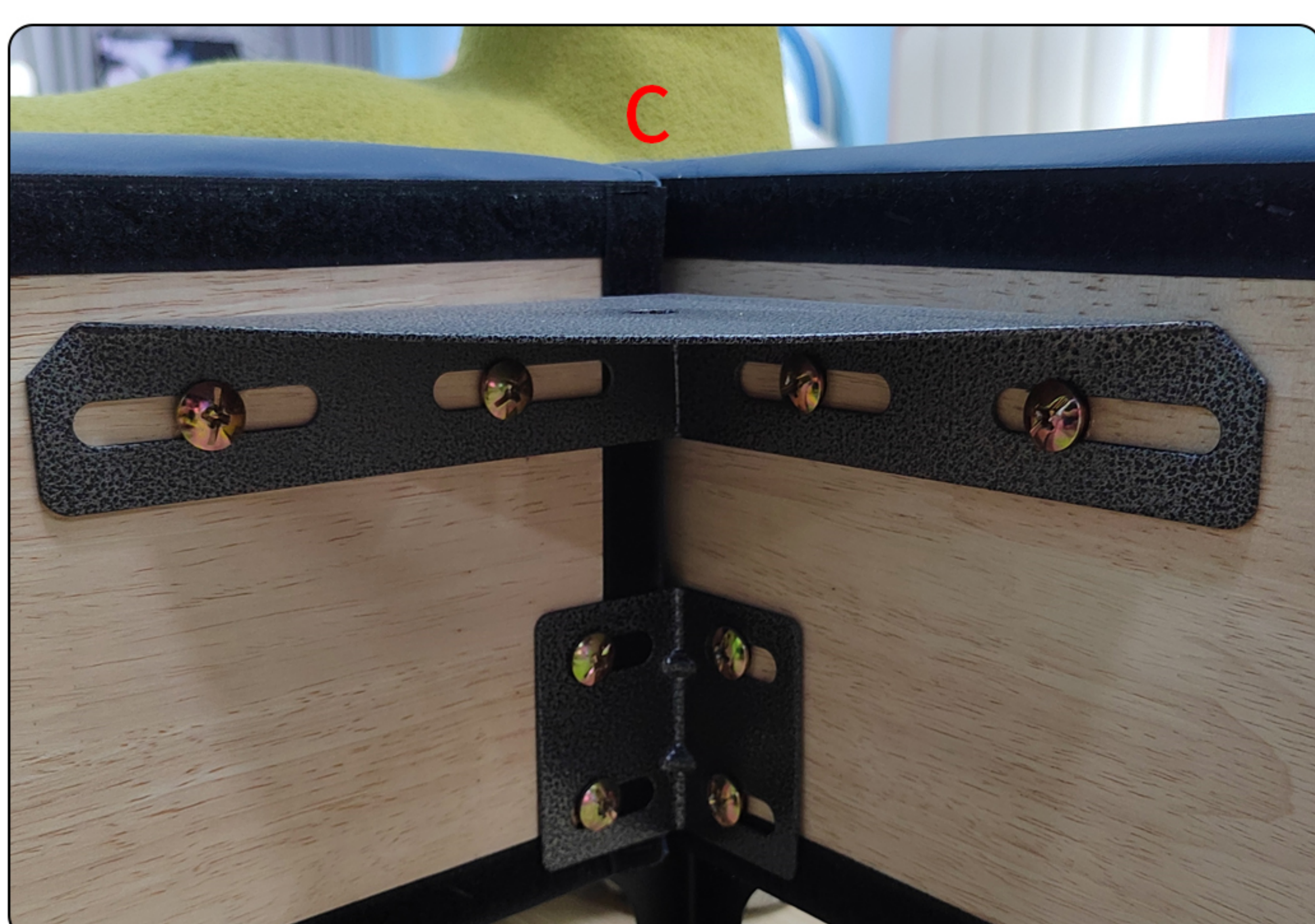
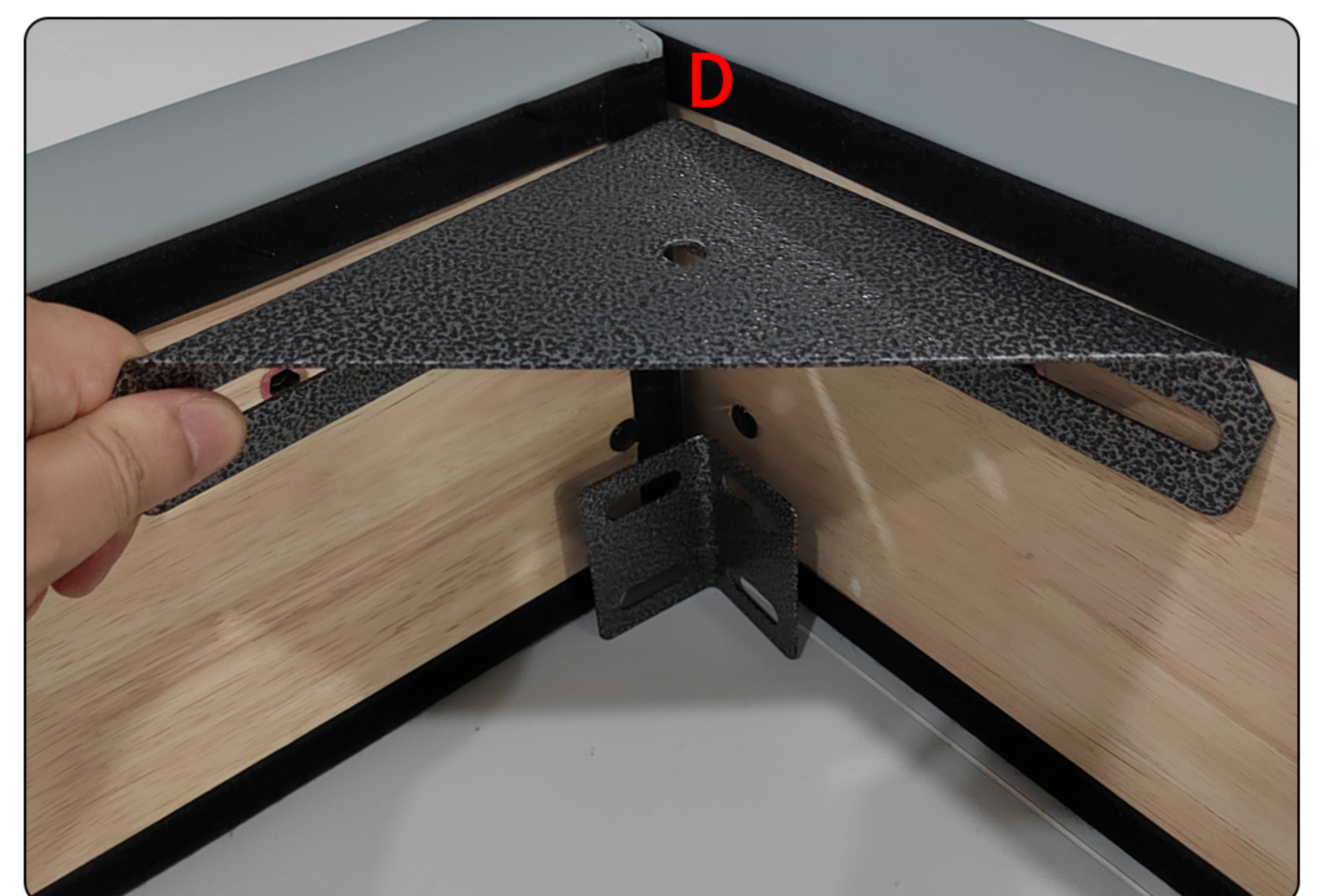
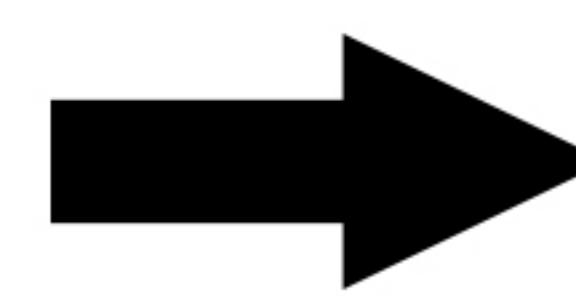

Step 3

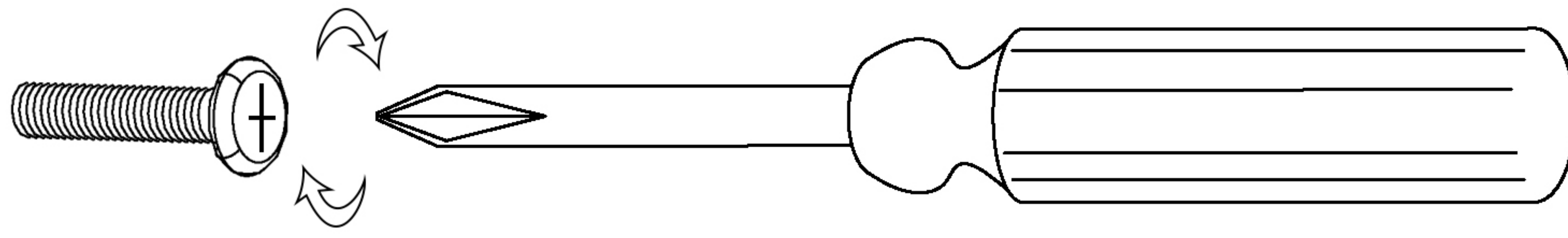

2

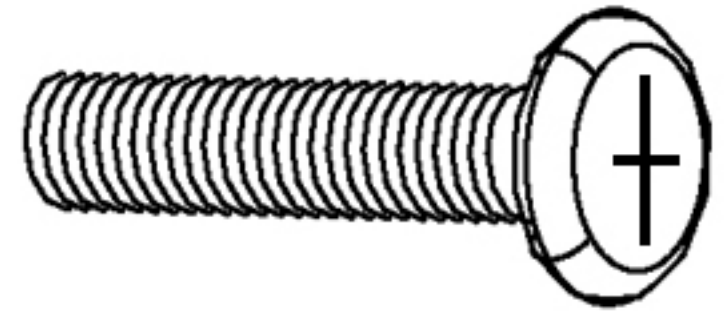

1/4" x 25 mm
Hex head bolts - 16 pcs

7



52X75mm
CORNER BRACE-2 pcs

8



40X175mm
CORNER BRACE-2 pcs

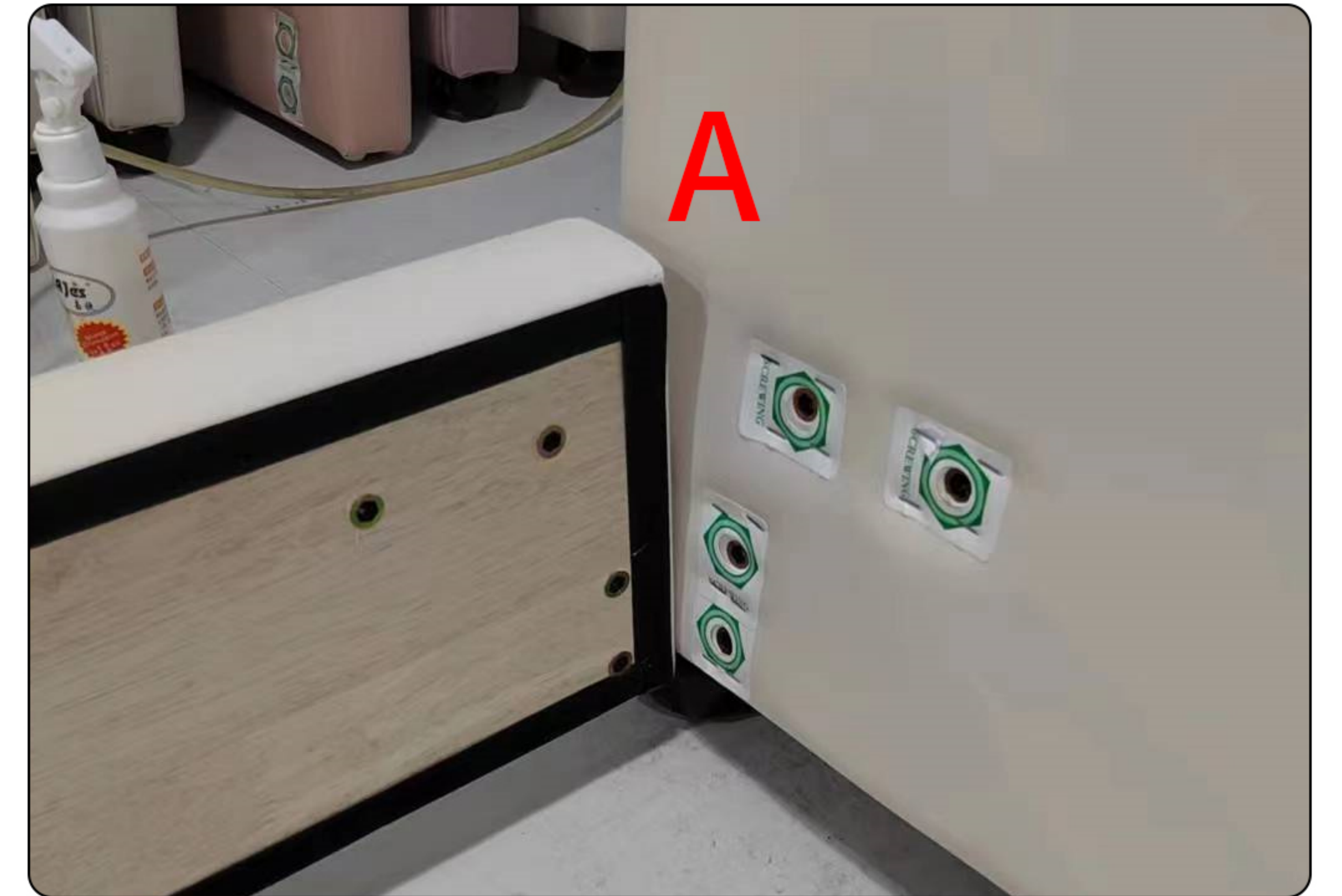
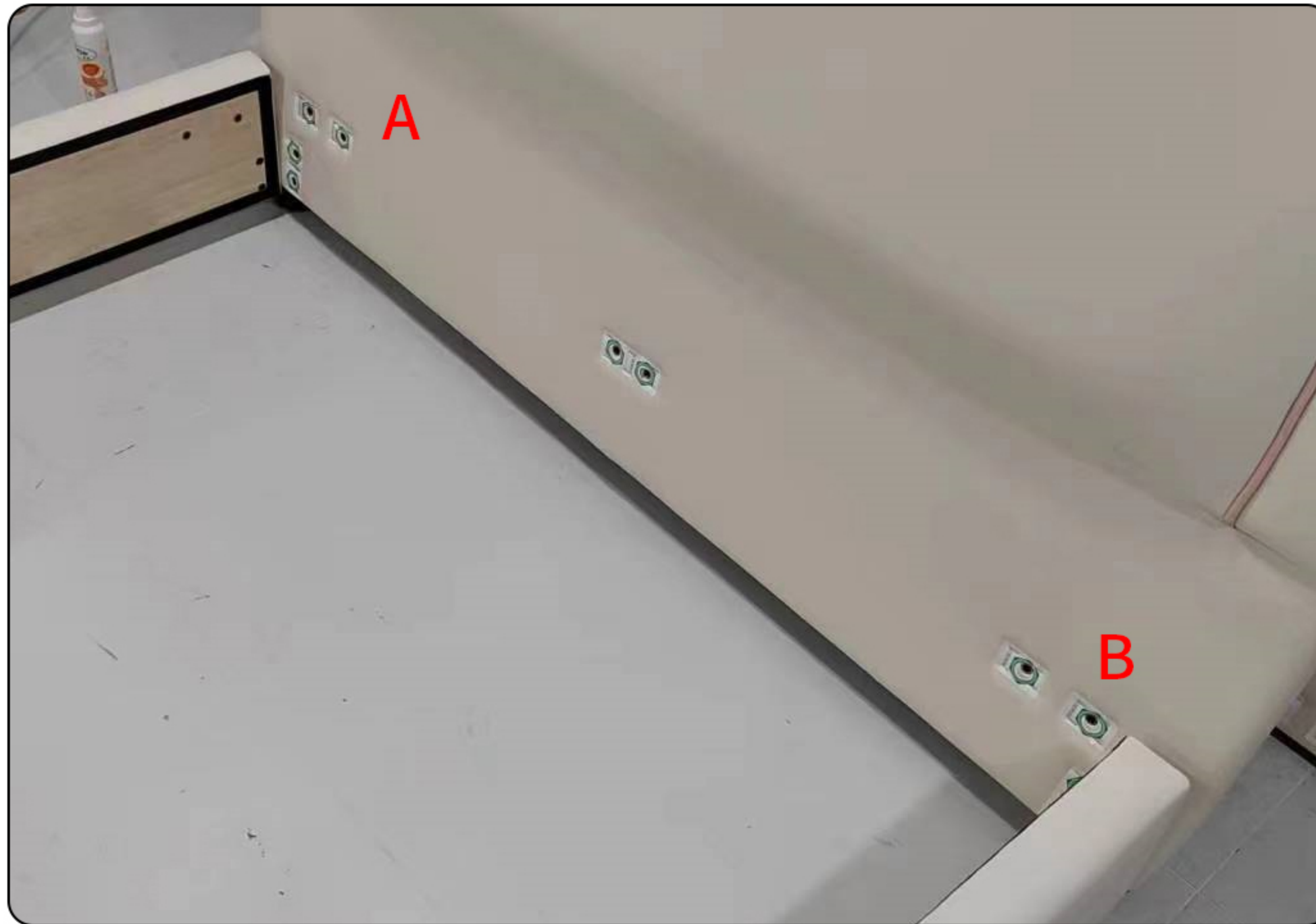

Step 4

2

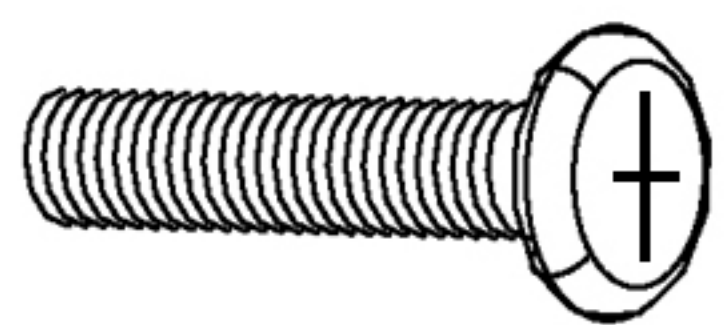

1/4" x 25 mm
Hex head bolts - 8 pcs

6



41X99MM
CORNER BRACE-4 pcs

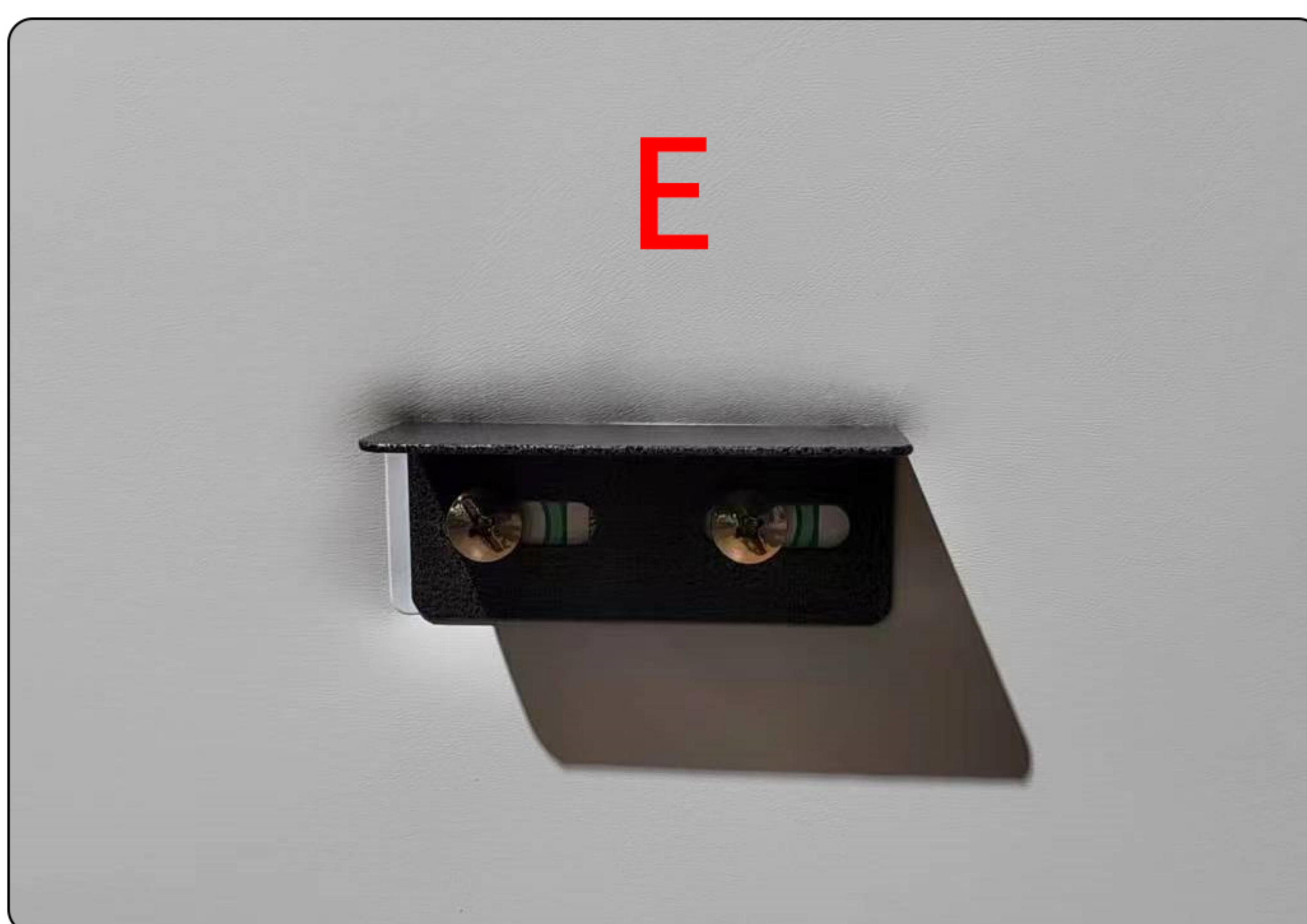

Step 5

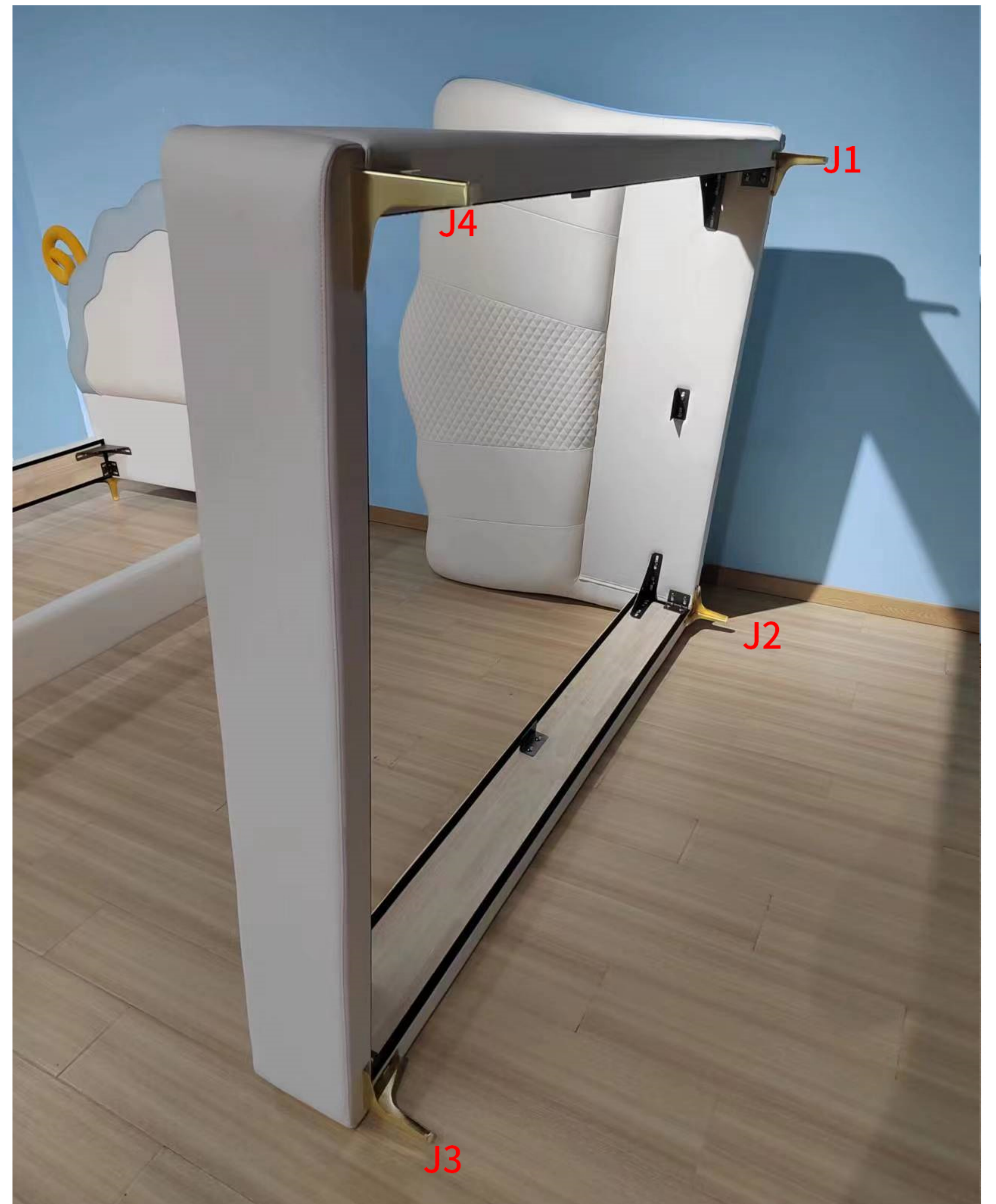
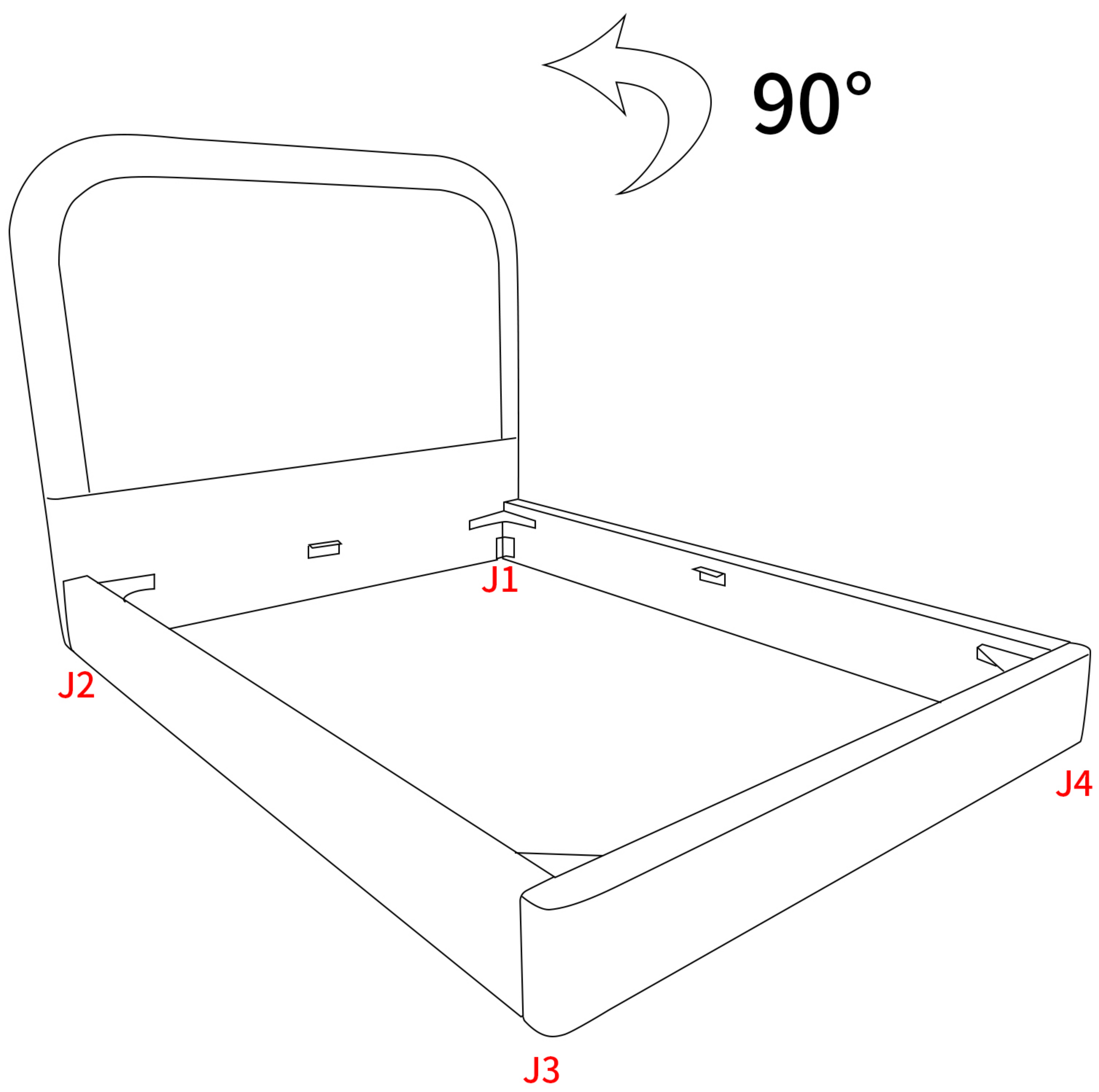

Step 6

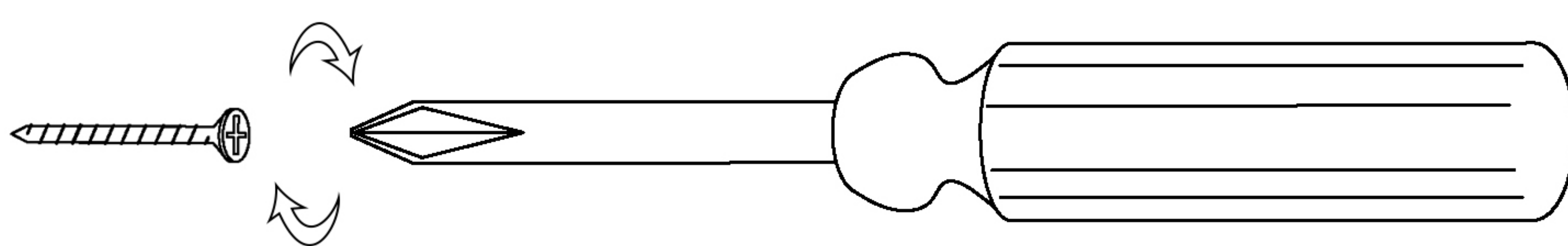

2



m4 x 25
Wood screws - 12 pcs

9



131X111mm
BED FOOT-4 pcs

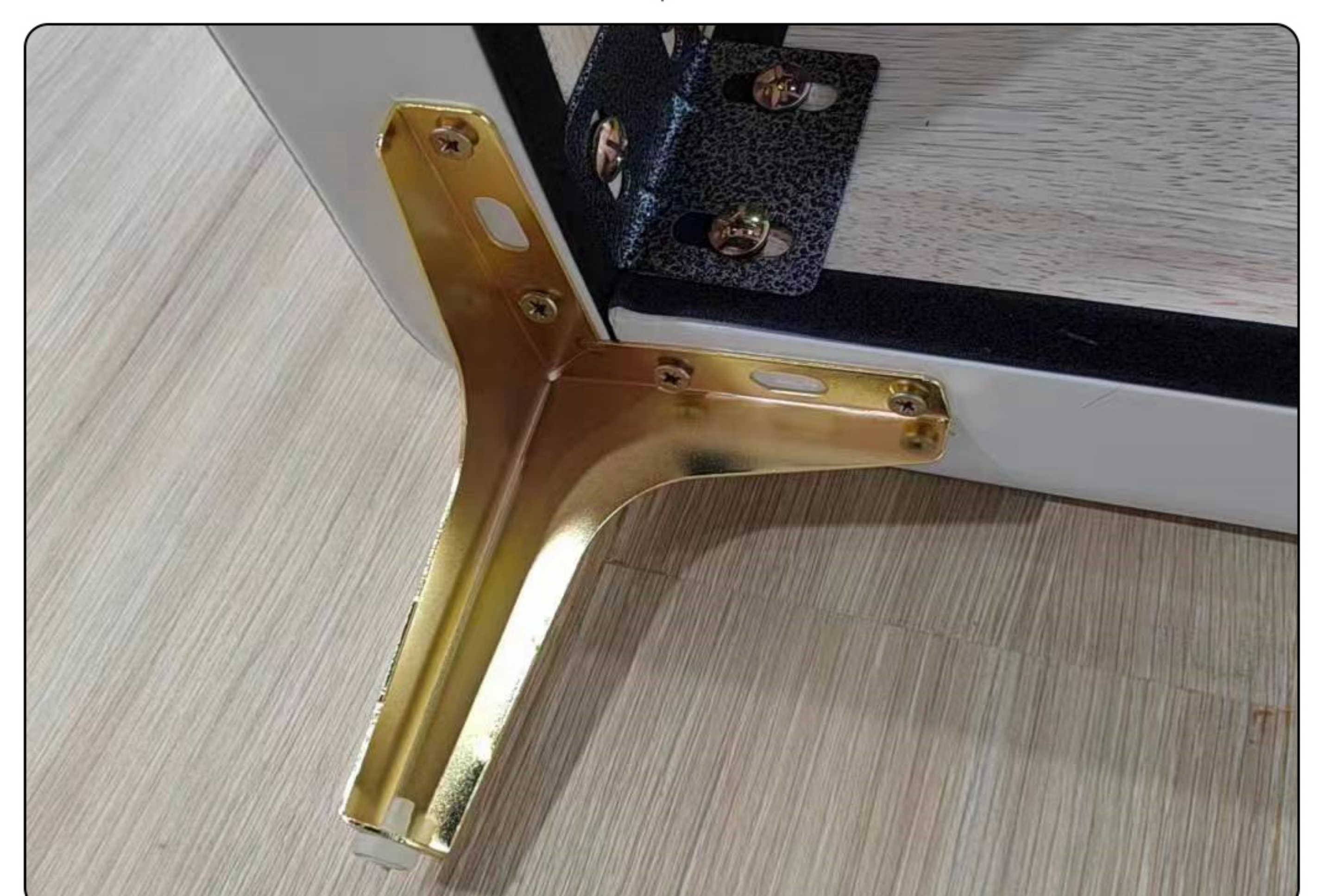
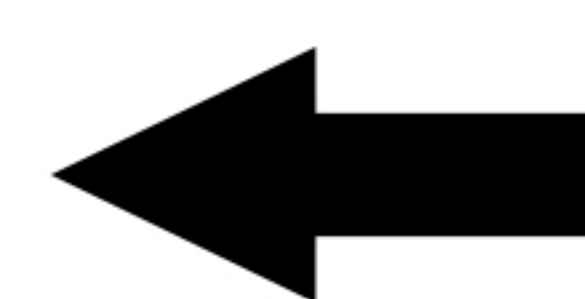
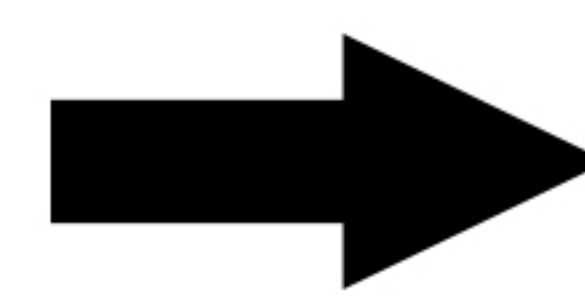

Step 7

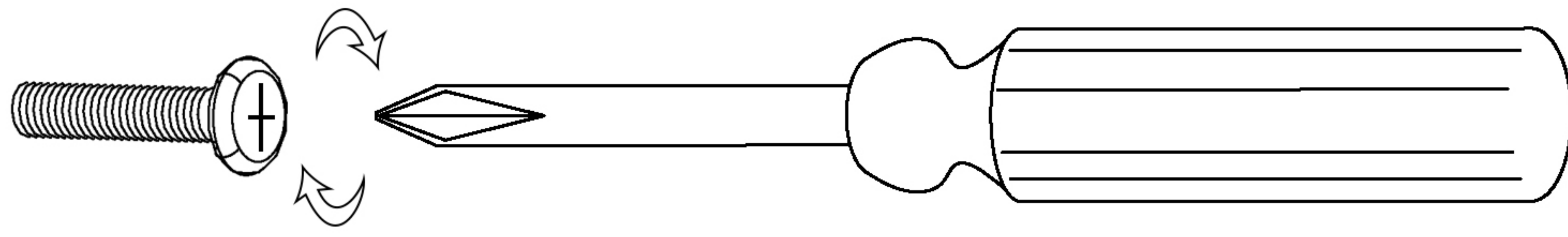

10



111X197-330mm
ADJUSTER FOOT-2 pcs

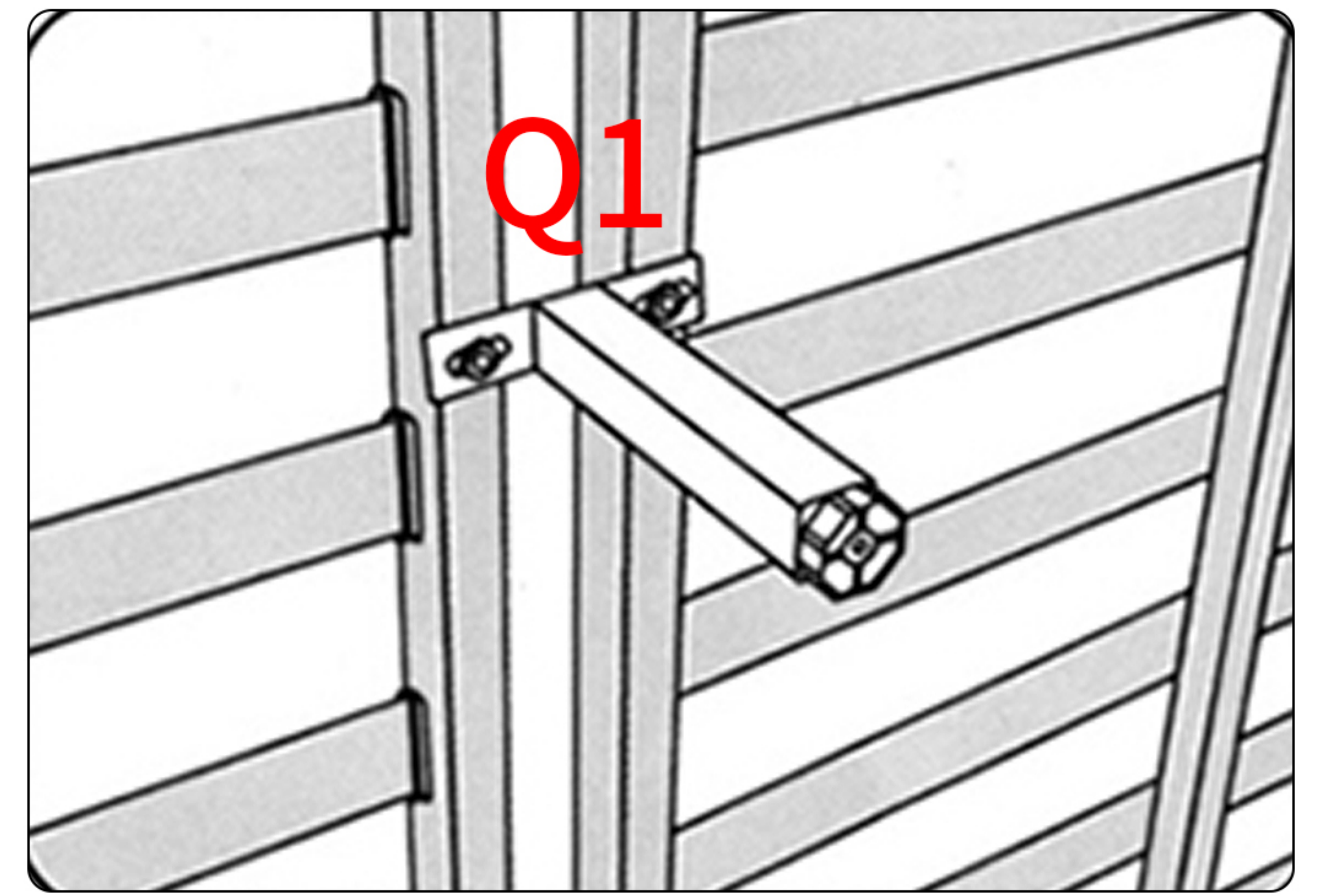
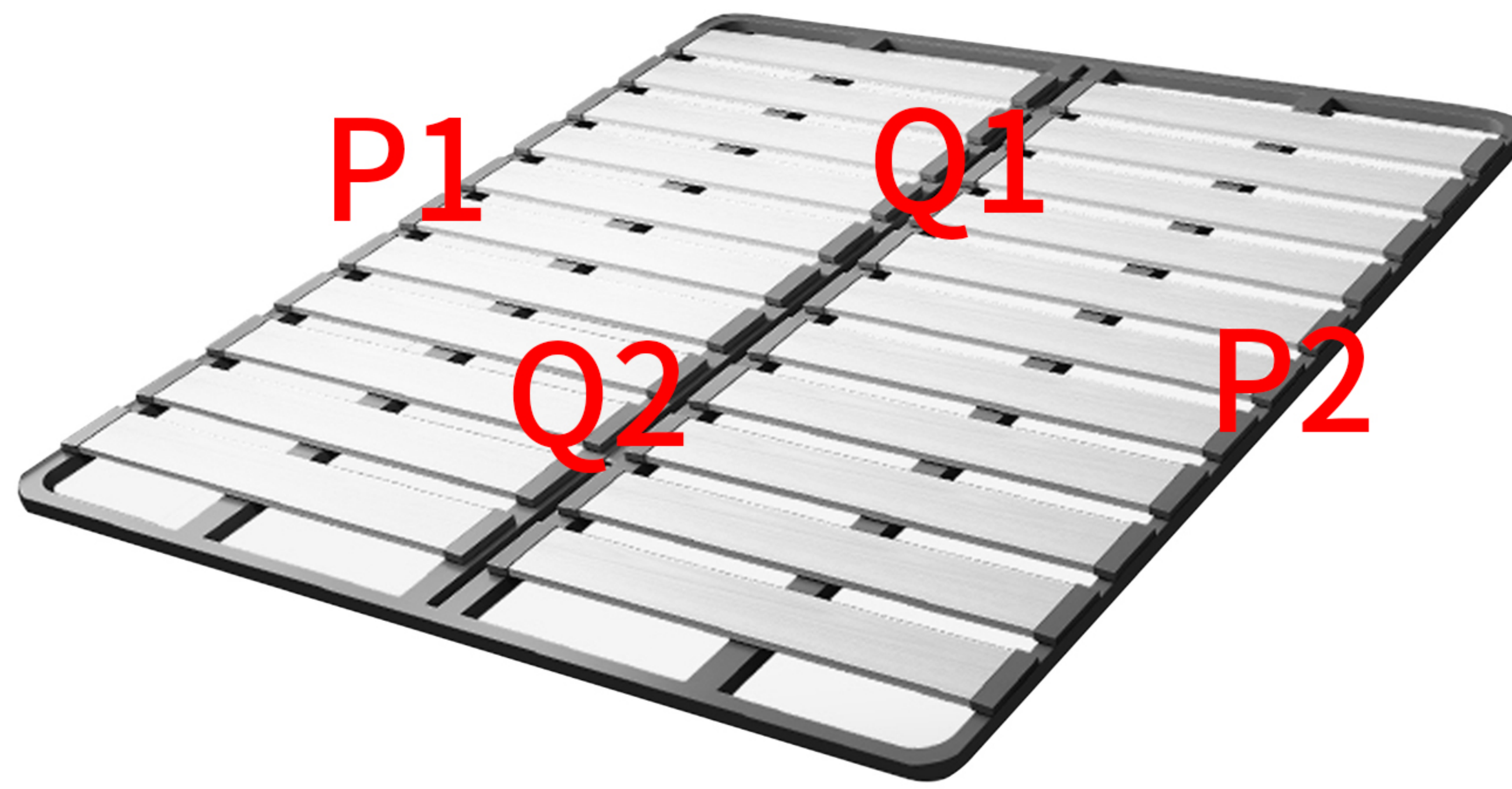

1

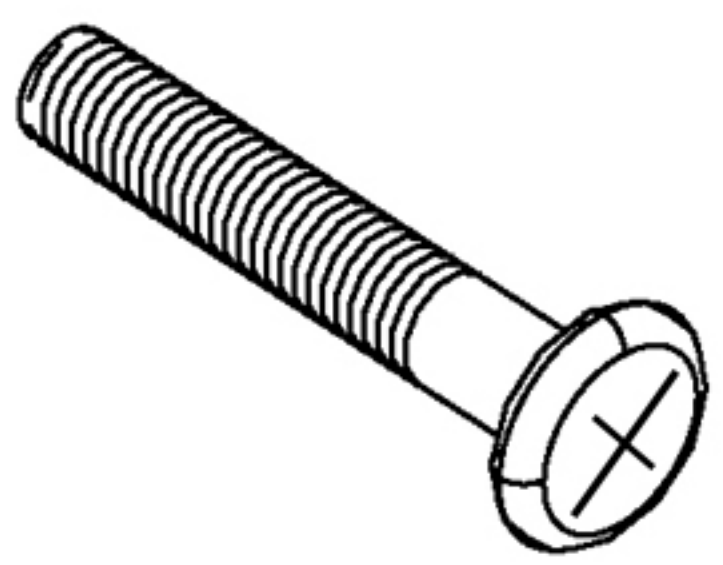

1/4" x 55 mm
Hex head bolts - 4 pcs

Rotate to adjust height:197-330mm



4

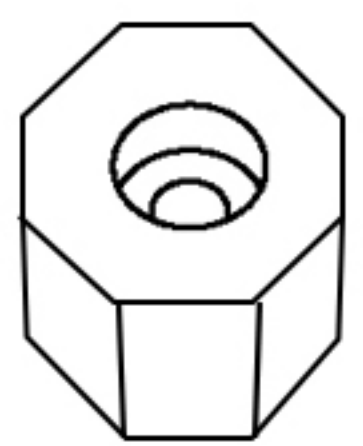

connecting bar - 4 pcs

Step 8

Rotate to adjust height:197-330mm

1

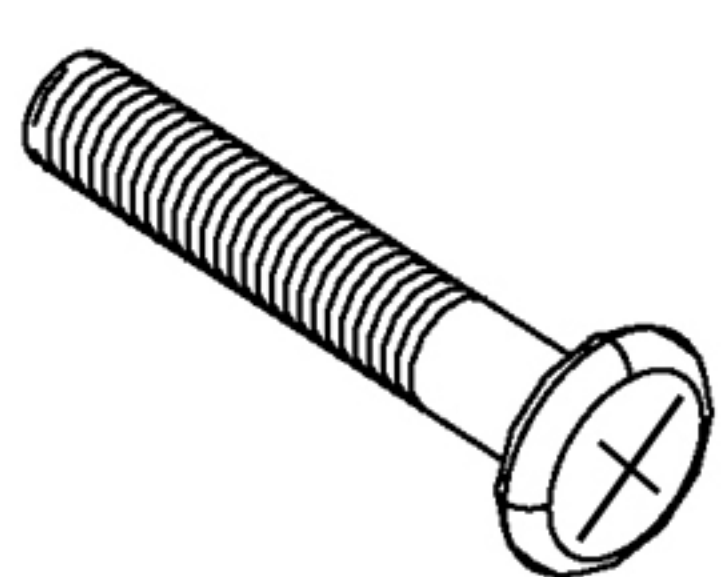

1/4" x 55 mm
Hex head bolts - 2 pcs



11



45X197-330mm
ADJUSTER FOOT-2 pcs

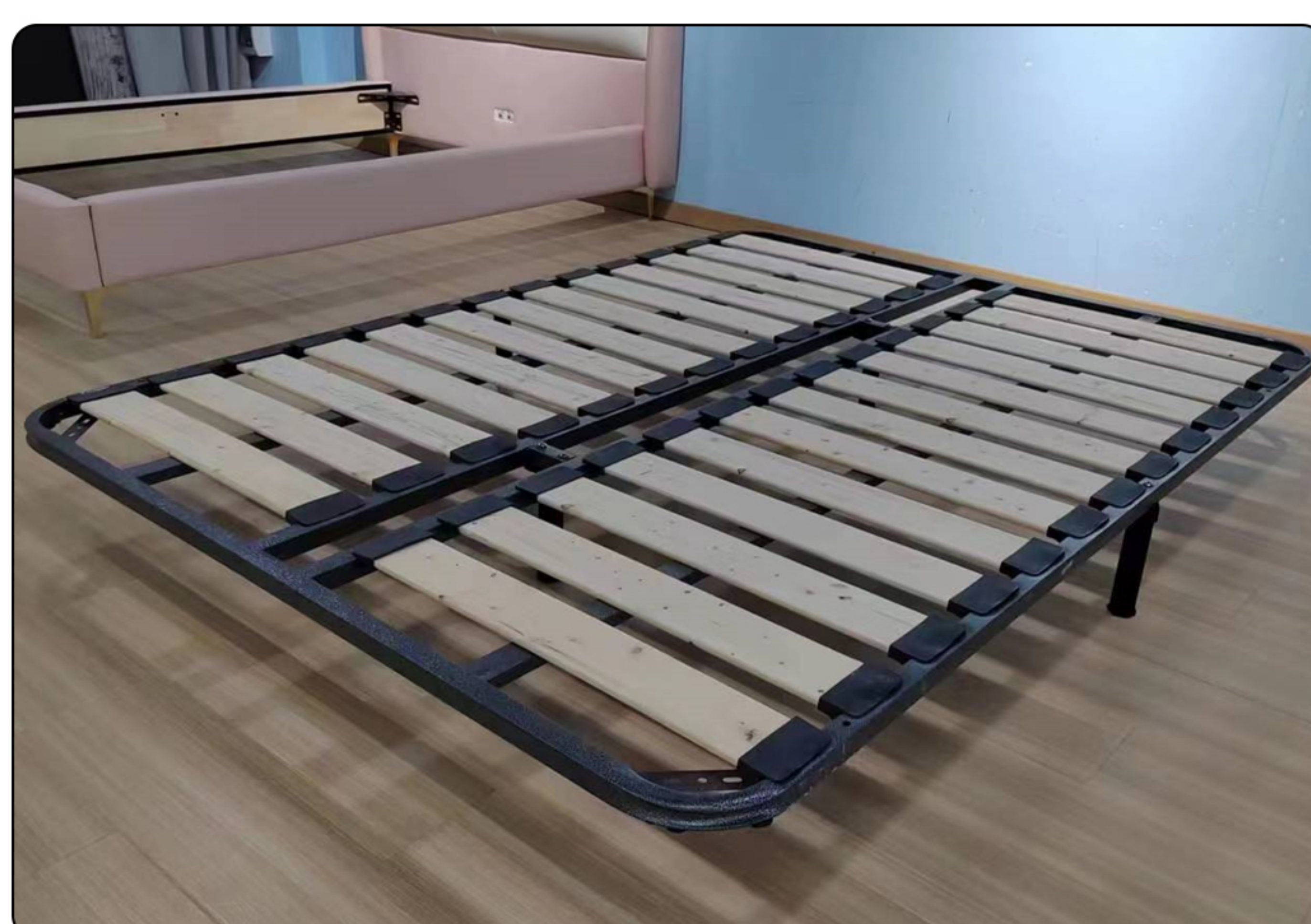

Step 9

STICK SILENT COTTON PADS ON ALL FOUR CORNERS

5



Ø 25X3mm
Mute pad-10 pcs



JUST PUT THE INSTALLED ROW FRAMEWORK ON TOP AND IT'S DONE

Step 10

